

**Oracle® Enterprise Manager**

Concepts

11g Release 11.1.0.1

**E11982-03**

May 2011

Oracle Enterprise Manager Concepts, 11g Release 11.1.0.1

E11982-03

Copyright © 2011, Oracle and/or its affiliates. All rights reserved.

This software and related documentation are provided under a license agreement containing restrictions on use and disclosure and are protected by intellectual property laws. Except as expressly permitted in your license agreement or allowed by law, you may not use, copy, reproduce, translate, broadcast, modify, license, transmit, distribute, exhibit, perform, publish, or display any part, in any form, or by any means. Reverse engineering, disassembly, or decompilation of this software, unless required by law for interoperability, is prohibited.

The information contained herein is subject to change without notice and is not warranted to be error-free. If you find any errors, please report them to us in writing.

If this software or related documentation is delivered to the U.S. Government or anyone licensing it on behalf of the U.S. Government, the following notice is applicable:

U.S. GOVERNMENT RIGHTS Programs, software, databases, and related documentation and technical data delivered to U.S. Government customers are "commercial computer software" or "commercial technical data" pursuant to the applicable Federal Acquisition Regulation and agency-specific supplemental regulations. As such, the use, duplication, disclosure, modification, and adaptation shall be subject to the restrictions and license terms set forth in the applicable Government contract, and, to the extent applicable by the terms of the Government contract, the additional rights set forth in FAR 52.227-19, Commercial Computer Software License (December 2007). Oracle USA, Inc., 500 Oracle Parkway, Redwood City, CA 94065.

This software is developed for general use in a variety of information management applications. It is not developed or intended for use in any inherently dangerous applications, including applications which may create a risk of personal injury. If you use this software in dangerous applications, then you shall be responsible to take all appropriate fail-safe, backup, redundancy, and other measures to ensure the safe use of this software. Oracle Corporation and its affiliates disclaim any liability for any damages caused by use of this software in dangerous applications.

Oracle is a registered trademark of Oracle Corporation and/or its affiliates. Other names may be trademarks of their respective owners.

This software and documentation may provide access to or information on content, products, and services from third parties. Oracle Corporation and its affiliates are not responsible for and expressly disclaim all warranties of any kind with respect to third-party content, products, and services. Oracle Corporation and its affiliates will not be responsible for any loss, costs, or damages incurred due to your access to or use of third-party content, products, or services.

---

---

# Contents

<b>Preface</b> .....	xi
Audience .....	xi
Documentation Accessibility .....	xi
Structure .....	xii
Related Documents .....	xiii
Updated Terminology .....	xiii
Conventions .....	xiii
<b>1 New Features In Oracle Enterprise Manager 11g Grid Control Release 1</b>	
<b>New Features in Oracle Enterprise Manager 11g Grid Control Release 1</b> .....	1-1
Database Management .....	1-1
Performance Diagnostics .....	1-1
SQL Tuning .....	1-1
Real Application Clusters .....	1-1
High Availability .....	1-2
Oracle Clusterware .....	1-2
Oracle Grid Infrastructure .....	1-2
Data Masking Enhancements .....	1-2
Change Management Enhancements .....	1-2
Real Application Testing Enhancements .....	1-2
Middleware Management .....	1-2
My Oracle Support Integration .....	1-7
Lifecycle Management and Provisioning .....	1-7
Oracle Fusion Middleware Domain Provisioning .....	1-8
Oracle Fusion Middleware Domain Scale Up .....	1-8
Application Performance Management .....	1-8
Server Management .....	1-9
Enterprise Manager Grid Control Framework .....	1-10
<b>2 Introduction</b>	
<b>Quality of Service: Bridging the Business with IT Infrastructure</b> .....	2-1
<b>Enhanced Application Management and Monitoring</b> .....	2-1
Application Dependency and Performance .....	2-2
Real User Experience Insight .....	2-2
Business Transaction Management .....	2-2

Java Diagnostics .....	2-3
E-Business Suite, PeopleSoft And Siebel Management And Monitoring .....	2-3
<b>Lowering Management Costs Through the Grid .....</b>	<b>2-3</b>
Knowing What You Have and What You Are Running .....	2-3
Certified Configurations: Bringing Harmony to an Ever-Changing Data Center.....	2-3
Error-Free Automated Provisioning: Linux, Oracle RAC, Certified Images, Patches, Upgrades..	2-4
Patch Management.....	2-5
<b>Management for the Complete Oracle Grid Environment .....</b>	<b>2-6</b>
Extensions and Management Plug-ins.....	2-6
Oracle Integrated Management Partnerships .....	2-7
<b>Conclusion .....</b>	<b>2-7</b>

### 3 Overview of Enterprise Manager Grid Control

<b>Overview .....</b>	<b>3-1</b>
<b>Enterprise Manager Architecture .....</b>	<b>3-1</b>
<b>Key Features .....</b>	<b>3-3</b>
System Monitoring.....	3-3
Managing Groups .....	3-5
Job System .....	3-5
Information Publisher.....	3-6
Compliance Management .....	3-6
Extending Enterprise Manager .....	3-7
Managing Targets .....	3-8

### 4 Enterprise Configuration Management

<b>Hardware and Software Configurations.....</b>	<b>4-1</b>
Collected Configurations .....	4-1
Viewing Configurations.....	4-2
Comparing Configurations.....	4-4
The Enterprise Configuration.....	4-5
Viewing the Enterprise Configuration.....	4-5
Searching the Enterprise Configuration .....	4-5
Viewing the Enterprise Configuration History .....	4-6
Client Configurations .....	4-7
Client System Analyzer in Grid Control .....	4-7
Client System Analyzer Deployed Independently .....	4-7
<b>Accessing Configuration Pages in Grid Control.....</b>	<b>4-8</b>
<b>Configuration Change Console .....</b>	<b>4-8</b>
<b>Application Change Console .....</b>	<b>4-9</b>

### 5 Host and Third-Party Target Management

<b>Host Management .....</b>	<b>5-1</b>
Monitoring Hosts .....	5-2
Host Home Page .....	5-2
Host Performance Page.....	5-3

Host Configuration Page .....	5-4
Operating System Details .....	5-4
Hardware Details .....	5-5
Log File Monitoring .....	5-6
Program Resource Utilization Monitoring .....	5-6
File and Directory Monitoring .....	5-7
Hardware Monitoring for Dell PowerEdge Systems .....	5-7
Storage Resource Tracking .....	5-8
Host Administration .....	5-9
Linux Host Administration .....	5-9
Execute Host Command .....	5-10
Job System .....	5-10
Remote File Editor .....	5-10
Managing Host Deployments .....	5-11
<b>Third-Party Target Management</b> .....	5-11
Support for Third-Party Application Servers .....	5-11
Support for Third-Party Plug-Ins .....	5-12
Network Appliance Filer .....	5-13
F5 Load Balancer Switches.....	5-14

## 6 Database Management

<b>Introduction to Database Management</b> .....	6-1
Database Control Versus Grid Control .....	6-1
Database Home Page as the Management Hub .....	6-2
<b>Monitoring Databases</b> .....	6-3
Assessing Database Performance .....	6-4
Diagnosing Problems Interactively .....	6-6
Investigating a Wait Class .....	6-6
Viewing SQL Details .....	6-7
Viewing Session Details .....	6-7
Viewing Top Activity .....	6-8
Monitoring Real-time SQL.....	6-9
Diagnosing Problems Automatically .....	6-11
Using Additional Diagnostic Pages.....	6-12
Top Consumers .....	6-12
Instance Activity .....	6-12
Historical SQL .....	6-13
Using Other Performance Tools.....	6-14
Topology Viewer.....	6-14
AWR Baselines .....	6-15
Memory Access Mode.....	6-16
Hang Analysis .....	6-16
<b>Administering Databases</b> .....	6-16
Managing Storage Objects .....	6-17
Using Database Configuration Features.....	6-17
Using Automatic Storage Management.....	6-17
Converting Single Instances to Oracle Real Application Clusters.....	6-18

Converting to a Locally-Managed Tablespace.....	6-18
Controlling Resources with Resource Manager .....	6-18
Tracking Statistics to Improve Database Performance .....	6-18
Using Oracle Scheduler.....	6-18
Working With Database Schemas.....	6-19
Managing Database Objects .....	6-19
XML Database Features in Oracle Enterprise Manager .....	6-19
Managing Users and Privileges .....	6-20
Managing Materialized Views .....	6-20
About Change Management .....	6-21
Using Advisors in Oracle Enterprise Manager.....	6-21
<b>Managing Database Security .....</b>	<b>6-22</b>
Managing Users, Roles, Profiles, and Audit Settings .....	6-22
Transparent Data Encryption.....	6-23
Oracle Label Security (OLS).....	6-23
Virtual Private Database (VPD) .....	6-23
Application Contexts .....	6-24
Enterprise User Security.....	6-24
Oracle Database Vault .....	6-24
<b>Masking Sensitive Data for Non-production Use .....</b>	<b>6-25</b>
Security and Regulatory Compliance .....	6-25
Roles of Data Masking Users .....	6-25
Format Libraries and Masking Definitions .....	6-26
Recommended Data Masking Workflow .....	6-26
Data Masking Task Sequence.....	6-27
Defining New Masking Formats.....	6-29
Using Oracle-supplied Predefined Masking Formats .....	6-30
Patterns of Format Definitions.....	6-30
Category Definitions.....	6-31
Installing the DM_FMTLIB Package .....	6-32
Agent Compatibility for Data Masking .....	6-32
Supported Data Types.....	6-32
Creating a Masking Definition.....	6-33
Adding Dependent Columns .....	6-36
Cloning the Production Database.....	6-37
Using Reorganize Objects with LONG Columns.....	6-37
Using Data Masking with LONG Columns .....	6-39
Deterministic Masking .....	6-39
Use Cases.....	6-39
Related Oracle Security Offerings .....	6-40
<b>Maintaining Databases .....</b>	<b>6-41</b>
Using Backup.....	6-41
Recovery .....	6-41
Flashback Recovery.....	6-42
Backup and Recovery Settings .....	6-42
Managing Restore Points .....	6-43
Overview of Data Guard.....	6-43

<b>Additional Maintenance Features</b> .....	6-43
Exporting and Importing Features .....	6-43
Cloning Databases.....	6-44
Transporting Tablespaces .....	6-44
Overview of Oracle Streams .....	6-44
Working with Software Configurations .....	6-45
Using Database Software Patching.....	6-45
<b>Monitoring Oracle Real Application Clusters</b> .....	6-46
Cluster Cache Coherency .....	6-46
Cluster Interconnects .....	6-47
Cluster-Managed Database Services .....	6-48
Policy-managed and Administrator-managed Databases .....	6-49
Oracle Clusterware and High Availability.....	6-50
Database High Availability .....	6-50

## 7 Change Management for Databases

<b>Overview of Change Management for Databases</b> .....	7-1
<b>Dictionary Baselines</b> .....	7-2
Scope Specification.....	7-2
Capturing a Dictionary Baseline Version .....	7-4
Working With A Dictionary Baseline Version .....	7-4
Working With Multiple Dictionary Baseline Versions .....	7-5
Exporting and Importing Dictionary Baselines .....	7-6
Creating Directory Objects for Export and Import .....	7-7
<b>Dictionary Comparisons</b> .....	7-7
Defining Dictionary Comparisons.....	7-8
Working with Dictionary Comparison Versions.....	7-10
<b>Dictionary Synchronizations</b> .....	7-12
Defining Dictionary Synchronizations.....	7-13
Creating a Synchronization Definition from a Comparison.....	7-15
Working with Dictionary Synchronization Versions.....	7-16
The Dictionary Synchronization Cycle .....	7-16
Creating Additional Synchronization Versions.....	7-22

## 8 Service Management

<b>Introduction to Services</b> .....	8-1
Defining Services in Enterprise Manager .....	8-1
<b>Modeling Services</b> .....	8-2
Availability.....	8-2
Performance and Usage .....	8-3
Business Metrics .....	8-3
Setting Service-Level Rules.....	8-4
Monitoring Templates for Services.....	8-4
<b>Managing Systems</b> .....	8-4
Creating Systems .....	8-4
Monitoring Systems .....	8-5

<b>Monitoring Services</b> .....	8-6
Services Dashboard.....	8-6
System Topology.....	8-7
Service Topology.....	8-8
Reports.....	8-9
Notifications, Alerts, and Baselines.....	8-9
Service Performance.....	8-9
Monitoring Web Application Services.....	8-10
Transactions.....	8-10
End-User Performance Monitoring.....	8-10
Monitoring Forms Applications.....	8-11
Forms Transactions.....	8-11
End-User Performance Monitoring.....	8-11
<b>Diagnosing Service Problems</b> .....	8-12
Root Cause Analysis.....	8-12

## 9 Middleware Management

<b>Introduction to Middleware Management</b> .....	9-1
<b>Using Oracle Enterprise Manager Grid Control to Manage the Oracle Fusion Middleware Environment</b> .....	9-2
<b>Oracle Fusion Middleware Control versus Oracle Enterprise Manager Grid Control</b> .....	9-2
Managing Oracle Fusion Middleware with Fusion Middleware Control.....	9-2
Managing Oracle Fusion Middleware with Oracle Enterprise Manager 11g Grid Control ...	9-3
<b>Adding Middleware Targets to Oracle Enterprise Manager Grid Control</b> .....	9-4
Oracle Fusion Middleware Components.....	9-5
Oracle Application Server Components.....	9-7
Non-Oracle Middleware Components.....	9-7
<b>Out-of-Box Monitoring of Middleware Targets</b> .....	9-7
Target Home Page.....	9-7
Out-of-box Metrics.....	9-9
Analyzing Historical Performance.....	9-10
Setting Metric Thresholds for Alert Notifications.....	9-11
Monitoring Templates.....	9-11
Managing and Creating Blackouts.....	9-11
Extend Monitoring for Applications Deployed to WebLogic Server.....	9-12
Request Monitoring.....	9-12
Defining and Managing Transactions Being Monitored.....	9-13
<b>Diagnosing Performance Problems</b> .....	9-15
Using Home Pages to Diagnose Performance Issues.....	9-15
Using Application Dependency and Performance to Monitor Middleware Targets.....	9-16
Using Application Dependency and Performance.....	9-16
Using Java Diagnostics to Identify and Troubleshoot Performance Issues.....	9-17
Using Java Diagnostics in Oracle Enterprise Manager.....	9-17
<b>Administering Middleware Targets</b> .....	9-18
Process Control.....	9-18
Creating WebLogic Domain Groups.....	9-19
<b>Managing Configurations</b> .....	9-19



Policy Violations.....	9-20
<b>Managing Service Levels .....</b>	<b>9-20</b>
<b>Automating Operations .....</b>	<b>9-21</b>
Job System .....	9-21
Log File Rotation .....	9-21
Operations Automation .....	9-22
Cloning from Test to Production Environments.....	9-22
Scaling Out Domains.....	9-22
<b>10 Identity Management</b>	
<b>About Access and Identity Management .....</b>	<b>10-1</b>
<b>Using Grid Control for Monitoring Identity Management Targets .....</b>	<b>10-1</b>
Identity Component Server Home Page.....	10-2
<b>Identity Management Systems .....</b>	<b>10-3</b>
Configuring Identity Management Services .....	10-4
Monitoring Services .....	10-4
<b>Identity Management Root Cause Analysis .....</b>	<b>10-5</b>
<b>Automated Identity Management Monitoring and Alerts.....</b>	<b>10-5</b>
<b>Diagnosing Identity Management Performance and Availability Problems .....</b>	<b>10-5</b>
<b>Leveraging the Grid Control Management Framework .....</b>	<b>10-6</b>
<b>11 Oracle Beehive Management</b>	
<b>About Oracle Beehive.....</b>	<b>11-1</b>
<b>Using Grid Control for Monitoring Oracle Beehive Targets .....</b>	<b>11-2</b>
<b>Discovering Oracle Beehive Sites .....</b>	<b>11-4</b>
Oracle Beehive Site Home Page .....	11-5
Rediscovering an Oracle Beehive Site .....	11-6
Editing Availability Definition.....	11-6
About Metrics Analysis Report.....	11-7
<b>Oracle Beehive System and Services.....</b>	<b>11-7</b>
Creating and Resynchronizing Systems and Services .....	11-9
<b>Automated Oracle Beehive Monitoring and Alerts.....</b>	<b>11-9</b>
<b>12 Lifecycle Management</b>	
<b>Lifecycle Management Overview .....</b>	<b>12-1</b>
Advantages of Using Provisioning and Patching Features .....	12-2
Wide Coverage Across the Stack .....	12-3
<b>Server Provisioning .....</b>	<b>12-3</b>
<b>Customization .....</b>	<b>12-4</b>
<b>Provisioning Concepts .....</b>	<b>12-4</b>
Components.....	12-4
Directives.....	12-5
Images.....	12-5
Software Library.....	12-5
<b>Using the Provisioning Features .....</b>	<b>12-5</b>
Setting up and configuring the environment.....	12-5

Creating Components, Directives, and Images .....	12-6
<b>Patching</b> .....	12-6
My Oracle Support Integration .....	12-7
Patching Through Deployment Procedures.....	12-7
Patching Features .....	12-8
Patch Recommendations .....	12-9
Applying Patch Recommendations in Offline Mode .....	12-10
Accessing Patch Recommendation Pages in Enterprise Manager Grid Control .....	12-10
Application Server Patching .....	12-10
Linux Host Patching .....	12-10
Enhanced Linux Patching for ULN .....	12-11
Patching Features .....	12-12
Operating Systems Patching.....	12-12
Accessing Patching Pages in Grid Control.....	12-12

### **13 Virtualization Management**

<b>Introduction to Virtualization Management</b> .....	13-1
Virtualization Concepts.....	13-2
Supported Releases .....	13-4
Virtualization Central Page as the Management Hub.....	13-4
<b>Getting Started With Virtualization Management</b> .....	13-6
Creating Virtual Server Pool.....	13-9
Registering Virtual Servers .....	13-11
<b>Provisioning Guest Virtual Machines</b> .....	13-12
Creating Guest Virtual Machines .....	13-13
<b>Bare Metal Provisioning of Oracle VM Servers</b> .....	13-15
<b>Monitoring Oracle VM</b> .....	13-15
Oracle VM Server Home Page.....	13-15
Guest VM Home Page .....	13-17
<b>Administering Oracle VM</b> .....	13-18
Editing Guest VM.....	13-20
<b>Migrating from Oracle VM Manager to Enterprise Manager</b> .....	13-22
<b>Oracle Beehive Metrics</b> .....	A-1

### **Glossary**

### **Index**

---

---

# Preface

This manual introduces Oracle Enterprise Manager and describes the concepts required to use the product effectively to manage your Oracle environment.

Note that later versions of this and other Enterprise Manager books may be available on the Oracle Technology Network:

<http://www.oracle.com/technology/documentation/oem.html>

## Audience

This manual is intended for all users of Oracle Enterprise Manager.

## Documentation Accessibility

Our goal is to make Oracle products, services, and supporting documentation accessible to all users, including users that are disabled. To that end, our documentation includes features that make information available to users of assistive technology. This documentation is available in HTML format, and contains markup to facilitate access by the disabled community. Accessibility standards will continue to evolve over time, and Oracle is actively engaged with other market-leading technology vendors to address technical obstacles so that our documentation can be accessible to all of our customers. For more information, visit the Oracle Accessibility Program Web site at <http://www.oracle.com/accessibility/>.

### Accessibility of Code Examples in Documentation

Screen readers may not always correctly read the code examples in this document. The conventions for writing code require that closing braces should appear on an otherwise empty line; however, some screen readers may not always read a line of text that consists solely of a bracket or brace.

### Accessibility of Links to External Web Sites in Documentation

This documentation may contain links to Web sites of other companies or organizations that Oracle does not own or control. Oracle neither evaluates nor makes any representations regarding the accessibility of these Web sites.

### TTY Access to Oracle Support Services

To reach Oracle Support Services, use a telecommunications relay service (TRS) to call Oracle Support at 1.800.223.1711. Complete instructions for using the AT&T relay services are available at

<http://www.consumer.att.com/relay/tty/standard2.html>. After the AT&T Customer Assistant contacts Oracle Support Services, an Oracle Support

Services engineer will handle technical issues and provide customer support according to the Oracle service request process.

## Structure

The following preface and chapters discuss in greater detail Enterprise Manager functionality and applications:

### **Chapter 1, "New Features In Oracle Enterprise Manager 11g Grid Control Release 1"**

Presents an overview of the new features in Oracle Enterprise Manager 10g Release 5.1.

**Chapter 2, "Introduction"** Introduces, at a high-level, and puts into business-use context the features and benefits of using Enterprise Manager.

**Chapter 3, "Overview of Enterprise Manager Grid Control"** Describes the subsystems in Enterprise Manager.

**Chapter 4, "Enterprise Configuration Management"** Explains how Enterprise Manager simplifies the monitoring and management of the deployments in your enterprise.

**Chapter 5, "Host and Third-Party Target Management"** Describes Enterprise Manager's built-in features for managing host targets, as well as out-of-box third-party targets from non-Oracle vendors.

**Chapter 6, "Database Management"** Specifies the features Enterprise Manager includes to monitor, manage, administer, and maintain Oracle Databases.

**Chapter 8, "Service Management"** Explains how Enterprise Manager monitors and manages services and Web applications to determine the availability, performance, usage, and overall effectiveness of business implementations.

**Chapter 7, "Change Management for Databases"** Describes the Change Management feature in Enterprise Manager.

**Chapter 9, "Middleware Management"** Describes how Enterprise Manager provides an easy way to centrally manage your middle-tier Oracle Application Server environment.

**Chapter 10, "Identity Management"** Describes how to manage your Identity Management targets.

**Chapter 11, "Oracle Beehive Management"** Describes how you can use Enterprise Manager to manage your Oracle Beehive targets.

**Chapter 12, "Lifecycle Management"** Provides an overview of the server and software provisioning and patching features.

**Chapter 13, "Virtualization Management"** Introduces the concept of Virtualization Management in Enterprise Manager.

**Appendix A, "Oracle Beehive Service Dashboard Metrics"** Lists the Beehive metrics.

## Glossary

Provides definitions of terms specific to Enterprise Manager.

## Related Documents

For more information, see the following manuals in the Oracle Enterprise Manager 11g Release 1 documentation set:

- *Oracle Enterprise Manager Administration*
- *Oracle Enterprise Manager Grid Control Installation and Configuration*
- *Oracle Enterprise Manager Advanced Installation*
- *Oracle Enterprise Manager Policy Reference Manual*
- *Oracle Enterprise Manager Metric Reference Manual*
- *Extending Oracle Enterprise Manager*
- *Oracle Enterprise Manager Command Line Interface*
- *SNMP Support Reference Guide*

The latest versions of this and other Enterprise Manager books can be found at:

<http://www.oracle.com/technology/documentation/oem.html>

Oracle Enterprise Manager also provides extensive online help. Click **Help** on any Oracle Enterprise Manager page to display the online help system.

## Updated Terminology

In previous versions of Oracle Enterprise Manager, Service Level Management was known as either Application Service Level Management or Application Performance Management.

## Conventions

The following text conventions are used in this document:

<b>Convention</b>	<b>Meaning</b>
<b>boldface</b>	Boldface type indicates graphical user interface elements associated with an action, or terms defined in text or the glossary.
<i>italic</i>	Italic type indicates book titles, emphasis, or placeholder variables for which you supply particular values.
monospace	Monospace type indicates commands within a paragraph, URLs, code in examples, text that appears on the screen, or text that you enter.



---

---

# New Features In Oracle Enterprise Manager 11g Grid Control Release 1

This chapter discusses the new features available in Oracle Enterprise Manager 11g Grid Control Release 1.

## New Features in Oracle Enterprise Manager 11g Grid Control Release 1

The following provides an overview of the new features included in Oracle Enterprise Manager 11g Grid Control Release 1.

### Database Management

Enterprise Manager 11g Grid Control Release 1 now supports the new features available in Oracle Database 11g Release 2. The new database management features in this release are discussed below.

#### Performance Diagnostics

- Enhanced Database Performance page
- Impact of ADDM findings on Top Activity (Top SQL, Top Sessions etc.)
- Top activity for standby databases, e.g. Active Data Guard databases used for reporting

#### SQL Tuning

- Active Reports support for Realtime SQL Monitoring and SQL Details
- PL/SQL execution monitoring in SQL Monitoring
- Alternate execution plan identification in SQL Tuning Advisor based on real-time or historical performance.
- Parallel SQL Profile recommendation in SQL Tuning Advisor to enable parallel execution of a long-running query.

#### Real Application Clusters

- Complete support for 11.2 policy managed clustered databases
- Auto-discovery of policy managed instances when new instances are added or existing instances relocated
- Conversion of single instance database to policy managed clustered databases

### **High Availability**

- Expanded automation for implementation of Oracle's MAA best practice configuration
- Enhanced Oracle Streams and Advanced Queuing management and monitoring

### **Oracle Clusterware**

- Monitoring and administration of application resource types and resources
- Configuration and management of Server Pools
- Push based alerts to Enterprise Manager about Oracle Clusterware resources
- Startup and shutdown of Oracle Clusterware

### **Oracle Grid Infrastructure**

- Monitoring of Oracle Restart, a critical component of Oracle Grid Infrastructure
- Management of ASM Cluster File System
  - Administration of ACFS, dynamic volume and ACFS snapshots
  - Monitoring of ACFS components for availability, space usage and performance
  - Optimal Disk Placement of ASM files and volumes
  - Support for enhanced security model including separation of SYSDBA and SYSASM privileges

### **Data Masking Enhancements**

- Pre-mask SQL support in the mask definition
- EMCLI support for masking operations such as import mask definition, generate script and execute masking
- Support for masking of heterogeneous databases, e.g. SQL Server, DB2, using Oracle Database Gateways

### **Change Management Enhancements**

- Export and Import of dictionary baselines into external file for transfer between Enterprise Manager environments
- Real time tracking of schema changes supported for Oracle Database 11g databases

### **Real Application Testing Enhancements**

- Support for Replay filters
- Active Report support for SQL Performance Analyzer report

## **Middleware Management**

### **Enhanced Interface for Managing Oracle Fusion Middleware 11g**

Beginning with Enterprise Manager 11g Grid Control Release 1, the interface used to manage Oracle Fusion Middleware 11g is richer and easier to use. For instance, a navigation tree on the left-hand side of the page controls details displayed on the right. In addition, context sensitive menus provide easy access to commonly used



operations and features. In-context drill down support into the Oracle Enterprise Manager 11g Fusion Middleware Control and Oracle WebLogic Server Administration Console management interfaces is also provided.

### **Management and Monitoring of Oracle Fusion Middleware 11g Components**

Enterprise Manager Grid Control now supports the discovery, monitoring and central management of the entire family of Oracle Fusion Middleware 11g components. These new features streamline your ability to manage all Fusion Middleware targets directly from within Enterprise Manager Grid Control, without having to switch between Enterprise Manager Grid Control, Fusion Middleware Control and the WebLogic Server Administration Console user interfaces.

Supported targets include:

- Oracle WebLogic Server
- Oracle SOA Suite
- Oracle HTTP Server
- Oracle Web Cache
- Oracle Identity Management
- Metadata Services repositories
- Oracle WebCenter
- Oracle Portal
- Oracle Business Intelligence Discoverer
- Oracle Forms Services
- Oracle Reports
- User Messaging Service
- Applications built using the Oracle Application Development Framework (ADF)

### **Customizable Performance Summaries for Oracle Fusion Middleware 11g**

Enterprise Manager 11g Grid Control Release 1 now offers customizable performance summary pages for Oracle Fusion Middleware 11g components. You can modify the default settings for the new Performance Summary pages by:

- Choosing the performance metric charts to be displayed
- Arranging the order of charts
- Specifying the time range from which to display performance data
- Displaying performance data from multiple components in a single chart
- Displaying prior performance data alongside current performance data
- Saving a set of customizations made to the performance summary pages as a named chart set that can be accessed in the future.

The new performance summary pages allow you to resolve performance problems more quickly, perform trend analysis more easily, and correlate performance data across metrics more efficiently.

### **Support Workbench Support for Oracle Fusion Middleware 11g**

The Support Workbench, a tool for investigating and reporting problems in your Fusion Middleware environment, has been extended to support Oracle Fusion

Middleware 11g. The Support Workbench allows you to gather first-failure diagnostic data, obtain a support request number, and upload diagnostic data to Oracle Support with minimal effort in a short amount of time.

### **WebLogic Server Discovery and Management Features**

New features have been introduced to improve the user experience by adding the WebLogic Server and other Oracle Fusion Middleware targets to Oracle Enterprise Manager 11g Grid Control Release 1.

- **Add WebLogic Server Domains to Grid Control Via the EMCLI Utility**

Adding one or more WebLogic Server Domains to Grid Control through the Enterprise Manager Command Line Interface (EMCLI) is now supported.
- **Continuous Rediscovery of WebLogic Server Domains**

The process for refreshing WebLogic Server Domains has been automated, ensuring that the WebLogic Server Domain being monitored is always accurately represented in the Grid Control Console.
- **Improved User Experience for Adding WebLogic Server Domains to Grid Control**

The process of adding WebLogic Server Domains to Enterprise Manager Grid Control for central management and monitoring has been further automated, thereby improving productivity and reducing management costs. When adding a WebLogic Server Domain using a remote Management Agent, you are no longer required to manually copy the WebLogic jar files to the remote Management Agent machine.
- **Monitor WebLogic Server Domains During Administration Server Downtime**

Enterprise Manager Grid Control no longer requires the WebLogic Administration Server to be up in order to monitor and manage a WebLogic Server Domain and its contents. You can ensure continuous monitoring and management of a WebLogic Server Domain and its contents – even during Administration Server maintenance periods.
- **Monitor Each Managed Server Independently Within Domain**

When adding a WebLogic Server Domain to Enterprise Manager Grid Control, you can now choose which Management Agent should be used to monitor each Managed Server within the domain. For example, selecting an Agent that is local to the machine where the Managed Server is installed provides the ability to correlate WebLogic Server performance and configuration data with its underlying hardware and operating system performance and configuration data. It also provides the ability to provision Oracle Fusion Middleware.
- **Extend Monitoring for Applications Deployed to WebLogic Server**

Beginning with Enterprise Manager 11g Grid Control Release 1, you can add performance metrics beyond those available out-of-box for JMX-instrumented applications deployed on Oracle WebLogic Server. Businesses can now consolidate the monitoring of all JMX-enabled applications deployed to WebLogic Server into a single management tool – Enterprise Manager Grid Control.
- **WebLogic Server Installation and Patch Version Tracking**

Enterprise Manager now tracks installation-related information for Oracle WebLogic Server. You can easily track the number of WebLogic Server installations present across the datacenter, the associated versions and installation locations, and also identify the patches that have been applied.

- **Enhanced Configuration Collection for WebLogic Servers**

Additional configuration items including settings for resource adapters, web services, node managers, and machines will be collected as part of Enterprise Manager 11g Grid Control's daily collection of WebLogic Managed Server configuration data. Businesses can get a more comprehensive view of their WebLogic Server configurations. Consequently, tracking, analyzing, comparing, and searching across configurations is more complete.
- **New Target Types for Application and Clustered Application Deployments:**

Oracle Enterprise Manager 11g Grid Control Release 1 introduces new target types for Application Deployment and Clustered Application Deployment. Having specific target types for deployed Java EE applications enhances the application monitoring experience by enabling process control, thresholds, alert notifications, and target privileges for those deployed Java EE applications.
- **Creating WebLogic Domain Groups**

Monitoring several Oracle WebLogic Domains is simplified by allowing the creation of a new custom group target that represents the entire domain. This custom WebLogic Domain Group target type enables you to gain an overview of the availability, performance, configuration, and potential problem areas across the domains. You can access such health information from just a few pages rather than having to navigate to each domain's pages individually.

### **WebCenter Suite Monitoring**

Enterprise Manager Grid Control now provides application performance management for both Oracle WebCenter and Oracle WebLogic Portal with the following capabilities:

- Automatic discovery of critical components such as ADF Task Flows, Portal Desktops, Portlets, and JSF pages as well as their underlying dependencies
- Contextual drill-down provides visibility into performance bottlenecks within WebCenter and WebLogic Portal environments providing the critical metrics necessary to quickly pinpoint problems across applications both horizontally across those containers and vertically through the application stack all the way down to the database
- Change detection ensures the underlying model that identifies the dependencies and relationships between components is always up-to-date.

### **Oracle Fusion Middleware SOA Suite Monitoring**

Management of Fusion Middleware 11g Service-Oriented Architecture (SOA) composites and infrastructure has been enhanced to provide monitoring, fault management, configuration management, SLM, and deployment.

- SOA Composite Instance Tracing based on sensor value across multiple domains.
- Service, reference, and component metrics across BPEL, Mediator, Domain Services, and Human Workflow engines.
- Drill down to activity level metrics for BPEL components.
- Error monitoring and reporting for both business and technical faults in instance execution.
- Internal dependency views of wiring between components.

### **SOA Artifact Cloning Support**

A number of new deployment procedures that automate the provisioning of SOA artifacts are provided.

- Provisioning of SOA Composites  
Enables you to provision a new SOA composite or to provision a new version of an existing SOA composite to one or more WebLogic Domains.
- Automated Cloning of SOA Artifacts  
Enables easy cloning of SOA artifacts from a reference installation or gold image stored in the Software Library to an existing WebLogic Server Domain. SOA artifacts to be cloned include SOA composites, Web service policies, and Java Platform Security (JPS) configuration.
- Automated Deployment of SOA Composites  
Automating cloning of SOA domains enables you to provision new SOA domains by cloning an existing SOA domain including the underlying WebLogic Server infrastructure.

### **Web Services Management and Policy Features**

Web services management features of Fusion Middleware are now available through Enterprise Manager Grid Control.

Web service test functionality is supported, including the ability to test REST-style Web service endpoints.

- A new domain-level dashboard listing most commonly used policies, with elaborate policy violation metrics, is provided.
- New features for core SOA Governance are available, enabling you to monitor and govern the critical Web services from one central console.
- You can browse and import services registered in WSIL or UDDI registries.
- Monitoring capabilities have been enhanced to support historical data and trending. You can also set and view alerts to critical metrics.

### **New Oracle Identity and Access Management Functionality**

The former Identity Management plug-in has been included in the base installation of Enterprise Manager Grid Control. This eliminates the need to install a separate plug-in for monitoring Oracle Identity Management Suite 10g (including OID, DAS, DIP, and SSO) and simplifies the deployment procedure for customers.

Enterprise Manager Grid Control provides management capabilities for Oracle Identity Management 11g components (including Oracle Internet Directory, Oracle Virtual Directory, Directory Integration Platform, and Oracle Identity Federation) with the following capabilities:

- Single-step discovery for both Oracle Identity Management 10g and Oracle Identity Management 11g components allowing you to quickly set up your monitoring environment.
- Identity and Access page that provides a central location for discovering Identity Management components, creating systems and services, and monitoring the entire Identity Management environment.
- Provides a wide range of out-of-box performance metrics like CPU utilization, failed and successful authentications or authorizations, average response time, provisioning metrics, server and component status. These metrics help identify the

root causes of problems that slow down performance, extend response times, or create outages.

- Customizable performance summaries with a **Metric Palette** that allows users to drag and drop performance charts.
- Drill down into usage and performance statistics for:
  - \* Oracle Identity Federation Providers that show authentication requests and responses, HTTP and SOAP requests and responses, and authentication response processing time.
  - \* Oracle Internet Directory User Statistics that show failed and completed LDAP operations like Add, Bind, Compare, Delete, Modify, and Search.
  - \* Directory Integration Platform Synchronization and Provisioning Profiles that show job status, successful, skipped, or failed changes, completion time, and errors.
- Perform key configuration management tasks like keeping track of configuration changes for diagnostic and regulatory purposes, taking snapshots to store configurations, and comparing component configurations to ensure consistency of configurations within the same or across different environments.
- Enterprise Manager Grid Control provides a new wizard for creating Identity and Access Systems. The wizard automatically groups targets by their installations and allows the administrators to further add or remove components while creating the system.

## My Oracle Support Integration

### Seamless Access To My Oracle Support

Full integration with My Oracle Support (formerly Oracle MetaLink) is now provided, further enhancing Enterprise Manager Grid Control's ability to serve as a single interface for managing and supporting the enterprise. You now have seamless access to My Oracle Support console pages for managing Service Requests, deploying patches and reviewing Knowledge Base articles, all without leaving the Enterprise Manager Grid Control user interface.

The My Oracle Support console is personalized based on your login, so that you will see patch recommendations relevant to your environment. You can even view user-provided ratings and comments for specific patches.

## Lifecycle Management and Provisioning

### Patching Support for Oracle Database 11g Release 2 (11.2) Product Suite

This feature supports orchestrated patching of physical standby and Oracle Data Guard environments, enabling rolling patching of your data recovery environments in a single automated flow with zero downtime. This feature supports orchestrated patching of Oracle Database 11g Release 2 targets.

### Oracle Database Machine Provisioning

Automated deployment and configuration of Real Application Clusters (RAC) version 11.2 on the Sun Oracle Database Machine is now supported. By using Enterprise Manager-based deployment procedures, this feature greatly simplifies RAC deployment and configuration by requiring a minimum of inputs.

### **Real Application Cluster Provisioning to Support Oracle Database 11g Release 2 (11.2)**

This feature enables provisioning of the Real Application Clusters stack on database clusters. It complements the existing provisioning applications which enable provisioning of Oracle Database 10g and Oracle Database 11g Release 1 RAC stacks on cluster machines.

The RAC Provisioning Applications of Enterprise Manager provide a unified approach to install, scale-up and scale-down the Real Application Clusters (RAC) stack on a set of cluster machines.

Oracle Database 11g Release 2 Grid Infrastructure is a new entity that is built on Oracle Clusterware (CRS) and Oracle Automatic Storage Management (ASM). The version 11.2 release includes a number of changes from the earlier release. The following changes are relevant to RAC provisioning in Enterprise Manager:

- The Database 11.2 Clusterware Oracle Home can be configured for both the cluster services and the ASM services.
- Cluster configuration files like Oracle Cluster Registry (OCR) and Voting Disk can now be stored on ASM.
- The database listener will always be brought up from the Clusterware home.
- The cluster installation no longer requires the private hostnames and private IP addresses of a host.
- Oracle Automatic Storage Management Cluster File System (Oracle ACFS) is a new multi-platform, scalable file system, and storage management technology that extends Automatic Storage Management (ASM).
- New cluster configuration options have been added which take in new parameters.

### **Single Instance Database Provisioning to Support Oracle Database 11g Release 2 (11.2)**

Downloadable, dynamic prerequisite checks ensure you are fully prepared for database deployment. This feature also includes new deployment procedures to provision version 11.2 Oracle Restart (Single Instance High Availability) and Grid Infrastructure with Automated Storage Management (ASM) and enhancements to existing deployment procedures to support Oracle Database version 11g Release 2 (11.2).

### **Oracle Fusion Middleware Domain Provisioning**

A new deployment procedure enables you to easily clone the software binaries and/or configuration from a reference WebLogic Server Domain installation.

### **Oracle Fusion Middleware Domain Scale Up**

A new deployment procedure enables you to easily add capacity to an existing WebLogic Server Domain by adding a new Managed Server to the domain or by cloning an existing Managed Server already present in the domain.

## **Application Performance Management**

### **JVM Diagnostics Integrated Into Enterprise Manager Grid Control**

The new JVM Diagnostics feature combines previous features from Application Diagnostics for Java (AD4J) with additional deep metrics and direct context from

WebLogic Server and Domain pages as well as from Application Dependency and Performance and Request Monitoring. With this new feature, Java Virtual Machines (JVMs) are represented as targets within Enterprise Manager 11g Grid Control Release 1. Additionally, this feature allows access to metrics from a centralized starting point and provides additional integration points with the AD4J user interface.

### **Application Dependency and Performance Integrated Into Enterprise Manager Grid Control**

This feature provides an integrated solution that allows a coherent and unified view of managed applications. Features from the formerly stand-alone Composite Application Monitor and Modeler (CAMM) are now integrated into Enterprise Manager Grid Control. This allows access to deeper-dive metrics and contextual views (topology, functional views, architectural views) from a centralized starting point and easier access to Application Dependency and Performance features.

### **Request Monitoring for Java EE Applications**

The Request Monitoring feature provides end-to-end visibility into requests for Java applications deployed to WebLogic Server. It establishes a clear view of a request flowing through a multi-tier java environment.

- Real time visibility into business request volumes and critical system components, enabling a specific bottleneck within the overall request which may span multiple containers to be identified
- Highly flexible request tracing across multi-tier infrastructures provides deep details when threshold violations occur
- Request analysis identifies bottlenecks within actual request topology and provides comparisons between business transactions

## **Server Management**

### **Support for Oracle Virtualization Management Release 2.2**

This feature provides more flexibility in using third-party storage providers and networks infrastructures, including the following:

- A virtualized environment with minimal down time and impact during the server maintenance phase
- The capability to migrate your existing physical servers to a virtualized environment (P2V)
- The capability to migrate the VMWare Virtual Machines to Oracle VM (V2V)
- Using resource constraint features over CPU and Disk I/O resources for proper resource utilization and management in the data center
- Enabling of the Quality of Service (QoS) feature for the virtual disks (shared and additional) and specifying the priority for disk I/O operations for the virtual machine
- Better error status handling
- Creation of hardware virtualized templates from existing physical machines
- Conversion of VMware virtual machines to templates

## Enterprise Manager Grid Control Framework

### Enhanced High Availability Support

Several enhancements have been made to facilitate high availability configuration of Enterprise Manager Grid Control:

- Simplified process for adding additional Oracle Management Service (OMS) instances to your environment via a single configuration tool (OMSCA)
- Ability to update the configuration properties for an OMS instance, such as debug level, without stopping and re-starting the instance
- Simplified software load balancer configuration, eliminating the need for such tasks as hand editing of Oracle HTTP Server configuration files

### Extended Audit Operations

To further support regulatory compliance, auditing capabilities have now been extended to include the following operations in Enterprise Manager Grid Control:

- Changes to monitoring settings for a specific target
- Creation, modification, and deletion of monitoring templates
- Login/logout to database target events
- Database startup/shutdown events

### Support For Converting Non-privilege-Propagating Groups To Privilege-Propagating Groups

Privilege-propagating groups facilitate the management of privileges across members of the group. An existing group can now be converted to a privilege-propagating group using the `modify_group` EMCLI verb.

### Enhanced Security For Enterprise Manager Grid Control Communications

Transport Layer Security (TLS) v1 support for communications among Enterprise Manager Grid Control components will more tightly protect transferred data against "man-in-the-middle attacks". This enhancement will also better enable you to comply with strict security compliance standards, if required.



---

---

## Introduction

The Oracle Grid offers a proven solution that allows businesses to heighten application performance and \deliver unparalleled IT infrastructure reliability. Businesses of all sizes attain measurable IT cost savings by extending the availability of computing resources, cultivating more productive and effective administrators, and achieving higher quality of service—all direct benefits of the Oracle Grid. A critical ingredient to achieving the full benefits of the Oracle Grid is employing the right solution for managing the grid systems and, most importantly, the applications that run on those systems.

Oracle Enterprise Manager 11g Grid Control Release 1 is Oracle's single, integrated solution for managing all aspects of the Oracle Grid and the applications running on it. Enterprise Manager Grid Control couples a potent, top-down monitoring approach to delivering the highest quality of service for applications with a cost-effective automated configuration management, provisioning, and administration solution. This powerful combination provides unequaled management for any size Oracle data center.

This chapter provides an overview of Enterprise Manager 11g Grid Control Release 1, its rich functionality, and the unique benefits it offers to Oracle customers.

### **Quality of Service: Bridging the Business with IT Infrastructure**

Until recently, business success measurements and IT infrastructure performance were rarely mentioned in the same conversation. Corporations treated the two distinctly—in part because of traditional organization structures—but mostly because existing management tools offered point solutions that only addressed a portion of the larger need. IT management priorities focused primarily on maintaining individual IT systems performance, largely disconnected from real business objectives and needs. Now companies realize that in order to manage bottom line profits and differentiate the quality of service they offer, they must gain insight into how businesses are affected by IT performance. This requirement has mandated innovation in management solutions, where tools must go beyond discrete systems management to focus on delivering application availability and performance levels that align with business priorities. Few management solutions—because of their limited view of the application and its life cycle—are up to the task.

### **Enhanced Application Management and Monitoring**

New and enhanced functionality in Enterprise Manager extends the application-level management and monitoring capabilities with rich graphical modeling, workflow-driven dashboards, and root-cause diagnostics. The net is that administrators can gain insight into end-user application availability issues through

the entire application stack, enabling quick identification and location of problems in the IT infrastructure that affect application performance.

Additionally, complementary functionality allows administrators to quickly identify and triage impacted applications when low-level system issues surface. Using the new features available in Enterprise Manager 11g R1, administrators can model and relate system components within the IT infrastructure that provide the backbone for service offerings.

Leveraging these system components, they can define applications, or services, that depend upon those systems, and select business transactions that are measured to determine availability and performance of those services.

The sections below provide an overview of Enterprise Manager's application management and monitoring features.

## Application Dependency and Performance

Enterprise Manager provides a model-driven intelligent monitoring and modeling platform for Java EE and SOA applications. Key features from the formerly stand-alone Composite Application Monitor and Modeler (CAMP) product are now integrated into Enterprise Manager Grid Control, providing an integrated solution that allows a coherent and unified view of managed applications. This integration provides access to fine-grained metrics and contextual views (topology, functional views, architectural views) from a centralized starting point.

## Real User Experience Insight

With Oracle Real User Experience Insight, you can maximize the value of your business critical applications by gaining visibility into real end-user experiences. By reporting on user traffic requested by, and generated from, your network, this feature set integrates performance analysis and usage analysis into a single offering.

Application monitoring for Oracle applications, including user session tracking and discovery of end-user performance issues, is enabled out-of-the-box with these plug-ins:

- Real User Experience Insight Accelerator for Siebel
- Real User Experience Insight Accelerator for E-Business Suite
- Real User Experience Insight Accelerator for JD Edwards EnterpriseOne
- Real User Experience Insight Accelerator for PeopleSoft

## Business Transaction Management

Management of your SOA infrastructure is enhanced with Enterprise Manager's Business Transaction Management solution, which offers a comprehensive blend of transaction tracing/monitoring and SOA governance. The solution provides such features as:

- Real-time monitoring of synchronous and asynchronous business transactions through a complex application environment
- Visibility into performance issues, enabling you to answer such questions as "Which customer order is affected by this SOAP exception?"
- Active management and enforcement of service-level agreement (SLA), usage, and business requirements set on services

## Java Diagnostics

JVM Diagnostics enables administrators to monitor Java applications and diagnose performance problems in production. Administrators can identify the root cause of performance problems in the production environment without having to reproduce them in the test or development environment. JVM Diagnostics provides real-time JVM visibility and historical diagnosis. JVM Pooling and Tracing are other features that allow to analyze heaps and diagnose performance problems.

## E-Business Suite, PeopleSoft And Siebel Management And Monitoring

Enterprise Manager provides enhanced management and monitoring support for E-Business Suite systems, including Oracle Applications Manager; PeopleSoft environments; and Siebel Customer Relationship Management (CRM) applications. A comprehensive set of availability and performance metrics are collected for all environments, enabling immediate identification of issues.

## Lowering Management Costs Through the Grid

The number of systems and diversity of services in the Grid can be small or quite large. Historically, the cost of managing large sets of systems has increased linearly, or more, with each new system added to the enterprise. It's simply not possible to maintain management costs in the Grid environment with traditional management solutions that do not scale. The fundamental value proposition of Enterprise Manager Enterprise Manager Grid Control is to maintain management costs at a flat or near flat rate as the number of managed systems increases. There are a number of things that make this possible.

## Knowing What You Have and What You Are Running

For years, IT departments have relied upon the knowledge of key individuals who manually installed, configured, and maintained the systems running throughout an enterprise. Keeping systems up and running was often a finely-tuned recipe book of details written in a language only those closely involved could understand. Yet, as distributed systems evolved and service architectures became more complex and heterogeneous, manual solutions were no longer viable from a cost-effective standpoint—and more pressingly, from a quality of service standpoint. Administrators are now responsible for far more systems, and the relationships between those systems are much too complicated to track manually. Firewalls, switches, load-balancers, application servers, databases, and clusters are all distributed and connected through complex rules that demand reliable, automated configuration management.

Enterprise Manager Grid Control's configuration management solution is designed to eliminate the costs and errors that plague traditional manual configuration management solutions. Enterprise Manager Grid Control centrally tracks hardware, software installation (including patch levels), and software configuration data for every service and system that it manages. This detailed information is regularly and automatically collected and updated as changes occur. Central storage of enterprise configuration information lays the foundation for defining, deploying, auditing, enforcing, and maintaining the systems throughout the Grid.

## Certified Configurations: Bringing Harmony to an Ever-Changing Data Center

IT professionals will agree—the fewer variations in the types of systems deployed and the configurations used to deploy them, the easier systems are to manage and the

more reliable they will be. That said, it is impossible to expect, even with the most mature business practices, that all systems can follow the same standards of deployment. Using a robust configuration management solution, administrators can rely upon automated tools to ensure that all systems deployed follow specified practices and rules. This way, only pre-tested, pre-certified configurations can enter the production "food chain" of a busy data center.

Enterprise Manager Grid Control allows administrators to define rules (or policies)—most of which are available out-of-box—that are responsible for governing the configuration of all the systems and software running across the enterprise. And because the natural configuration life cycle of any system means it will be changed—through installation of patches, adding files and directories, changing ports, editing its dependencies, and so on—once a system is rolled out, Enterprise Manager Grid Control continually audits it against its predefined policies. All changes are tracked so that administrators know when they are happening, who is making them, what changes are acceptable, and what changes must be corrected. This level of security and compliance through proactive auditing and enforcement is necessary to keep harmony in the continual flux that defines most data centers. It is also critical to maintaining order and meeting compliance standards as new systems are brought on line, existing systems are upgraded, or patches are applied.

## **Error-Free Automated Provisioning: Linux, Oracle RAC, Certified Images, Patches, Upgrades**

Systems administrators can spend up to 25% of their time installing and configuring new software. Using Enterprise Manager Grid Control's automated provisioning tools, businesses can reduce the time spent deploying new software by up to 90%. Enterprise Manager Grid Control allows administrators to store base images in a central library—pre-configured and certified—from which new deployments can be based. Administrators can deploy fully configured Linux systems from bare metal. These systems can be deployed with any desired software configuration, certified to the appropriate version and patch level—all with a few simple clicks. This capability is extraordinarily powerful for Oracle Real Application Clusters (RAC) and application cluster environments where adding capacity can be done quickly and without errors. Specific capabilities designed for Oracle RAC and cluster systems, minimizing the number of steps and complexities involved, are now available.

Figure 2-1 Automated Oracle RAC Deployments and Extensions

The screenshot displays the Oracle Enterprise Manager Grid Control 11g interface for configuring software updates. The main title is "Patch Oracle RAC Database - All Nodes: Software Updates". The interface includes a breadcrumb trail: Home | Targets | Deployments | Alerts | Compliance | Jobs | Reports | My Oracle Support. Below the title, there are navigation buttons: Cancel, Step 1 of 7, and Next. The page content is organized into several sections:

- Select the Software Updates to Stage and Apply:** Includes options for Staging Location, TIP Directory, and TIP Staging of patches to a shared stage location.
- RAC Database Updates:** Includes instructions to select software updates and a table of available updates.
- Apply SQL Script:** Includes options to apply default SQL script or enter a custom script.
- Show Advanced Options:** Includes a section for Hide Variables for Target Properties with a table of variables.

Software Update Name	Patch ID	Created On	Type	Product	Platform	Release	Interim Patch	Applicable On	Description	README
p9001430_11.1.0.7.0_46	9001430	2010-03-20 07:42:17.0	Patch	Oracle Database Linux x86	11.1.0.7.0			ORA-600 [17090] RUNNING PYCREDBLSQL		View

At the bottom of the page, there is a footer with copyright information: Copyright © 1996, 2010, Oracle and/or its affiliates. All rights reserved. Oracle is a registered trademark of Oracle Corporation and/or its affiliates. Other names may be trademarks of their respective owners. About Oracle Enterprise Manager.

## Patch Management

Historically, managing the patches for any IT environment has been extremely tedious and difficult to control. In a Grid environment, where the number of systems and changes to those systems is widespread, manual patch management can become a full-time, often unproductive, job.

My Oracle Support is now integrated with Enterprise Manager Grid Control and provides a unified support and management experience. My Oracle Support provides the following:

- Comprehensive patch recommendations across security and other recommendations.
- New methodology to rollout patches using PLANs.
- Patch validation and single click conflict resolution of patches.
- Better information on patches such as downloads, trends, integration with community for patch reviews, and result validation.
- Integration with deployment procedures for automated deployments.

**Figure 2–2 Searching for Patches in the Context of a Specific Target**

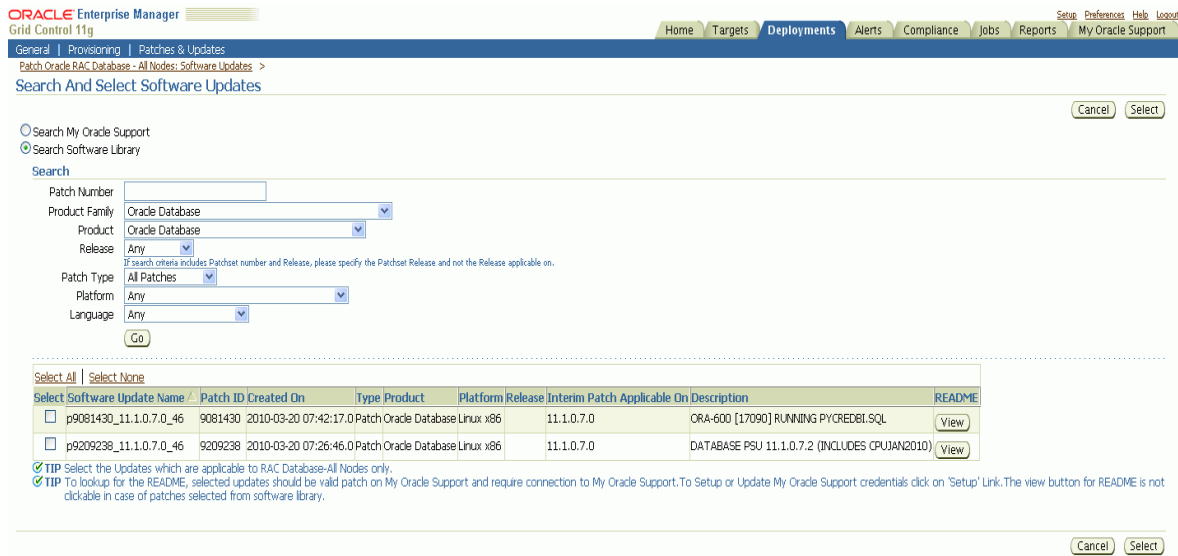

Using Grid Control to find, download, and deploy patches increases an administrator’s efficiency by automating mundane, repetitive, day-to-day maintenance tasks as much as possible, allowing them more time for proactive systems work.

## Management for the Complete Oracle Grid Environment

While Enterprise Manager 11g Grid Control provides the richest, most comprehensive management for Oracle products, it is also clear that there is no such thing as an Oracle-only environment. Customers have a wide variety of platforms, hardware, network, storage, and software components delivering critical functionality to the Oracle Grid, and they look for a single tool to monitor and manage this environment. With the latest release of Grid Control, there are two complementary initiatives that target extending the solution so customers can better leverage existing investments:

- Extending Grid Control's scope through native management extensions, and partner and custom plug-ins.
- Developing valuable integration solutions with existing management solutions to allow customers to leverage these investments without losing the unique value they gain from Grid Control.

### Extensions and Management Plug-ins

With Release 2, Enterprise Manager dramatically broadens the reach of its management solution. New extensions and plug-ins enable customers to leverage their investment in Grid Control to manage all the pieces of the application solution in a vendor-neutral way—components such as firewalls, server load balancers, and non-Oracle databases and application servers. Grid Control also includes extensions of the core Grid Control product for F5 server load balancers and NetApp Filers. Over the coming months, many more extensions will be generally released and available as easy-to-implement plug-ins. These plug-ins will be both Oracle-developed (e.g., Checkpoint firewall, SQL Server, and others) and developed in partnership by third-party vendors, with support and validation by Oracle to provide a single console for primary monitoring and management of the Oracle Grid. In addition to the

---

management plug-ins available out-of-box, Grid Control offers an open Command Line Interface and illustrative examples for easily adding new targets and customizing management solutions for customer-specific environments. This extended breadth of coverage gives customers the ability to use Grid Control for central management of their complete environment.

## Oracle Integrated Management Partnerships

In addition to extending the direct reach of Grid Control, bi-directional integration support for other leading management solutions is a key priority. Customers who have invested in non-Oracle management solutions derive increased value from Oracle's integration efforts. Direct integration between Grid Control and products by HP, Micromuse, and EMC SMARTS are currently supported. As an example, the integration between HP OpenView Operations and Grid Control provides both depth and breadth of management capabilities based on a common view of management data. This new level of integration allows customers to seamlessly leverage Oracle's strength in database, application server, and applications management and HP OpenView's strength in host and network management.

Other complementary partnerships designed to deliver unique capabilities to Oracle customers (including storage management and the ability to dynamically flex data center capacity) are underway and will be announced shortly.

## Conclusion

Grid computing is poised to revolutionize the economics of delivering applications and services across the enterprise. Enterprise Manager 11g R1 allows customers to deliver heightened application performance and realize dramatic savings in IT administration and maintenance costs. Enterprise Manager's robust service level management functionality brings together business priorities with IT application performance requirements in ways it never has before. Rich configuration management and provisioning functionality eliminate the error-prone, manual tactics that plague most data centers and drive up the overall cost of management. In a time when administration resources are at a premium, and businesses are forced to tightly control IT spending budgets, Enterprise Manager 11g is a must-have tool for small and large enterprises that want to make the Grid a reality for their IT department.





---

---

## Overview of Enterprise Manager Grid Control

This chapter provides an overview of Enterprise Manager Grid Control and helps you understand its architecture and the various core components that are integrated within the product. It contains the following sections:

- [Overview](#)
- [Enterprise Manager Architecture](#)
- [Key Features](#)

### Overview

Enterprise Manager is a system management software that delivers centralized monitoring, administration, and life cycle management functionality for the complete Oracle IT infrastructure, including systems running Oracle and non-Oracle technologies. Your infrastructure may comprise multiple Oracle Databases, Oracle WebLogic Managed Servers, Web applications deployed on these servers, hosts running these targets, and so on. You can, of course, use the individual product consoles to monitor the status of each of these targets, but it becomes cumbersome to shuttle between multiple console windows and track the performance of each of these targets using so many windows.

Enterprise Manager offers a single-window solution that allows you to monitor and manage the complete Oracle IT infrastructure from a single console. Enterprise Manager Grid Control also offers support for monitoring certain non-Oracle products, for example, IBM WebSphere Application Server, Microsoft SQL Server, Juniper Networks NetScreen Firewall, and so on.

With a broad set of end-to-end monitoring, administration, configuration management, provisioning, and security capabilities, Enterprise Manager Grid Control reduces the cost and complexity of managing such grid computing environments. Robust service-level management functionality within Enterprise Manager Grid Control dramatically improves service levels through rich transaction and end-user performance monitoring and deep diagnostics for multi-tier Internet applications.

### Enterprise Manager Architecture

Although Enterprise Manager is viewed as a single entity, technically, it is built with the following software components:

- Oracle Management Service (OMS)
- Oracle Management Agent (Management Agent)
- Oracle Management Repository (Management Repository)

While OMS acts as the brain of the Enterprise Manager Grid Control architecture responsible for communicating with Management Agents and a central repository that stores information, Management Agent acts as the hands and legs of a body responsible for collecting information from the monitored targets and transporting them to OMS. And, Management Repository is the repository configured in Oracle Database to store the collected information.

The following illustrates the Enterprise Manager Grid Control architecture:

**Figure 3–1 Enterprise Manager Grid Control Architecture**

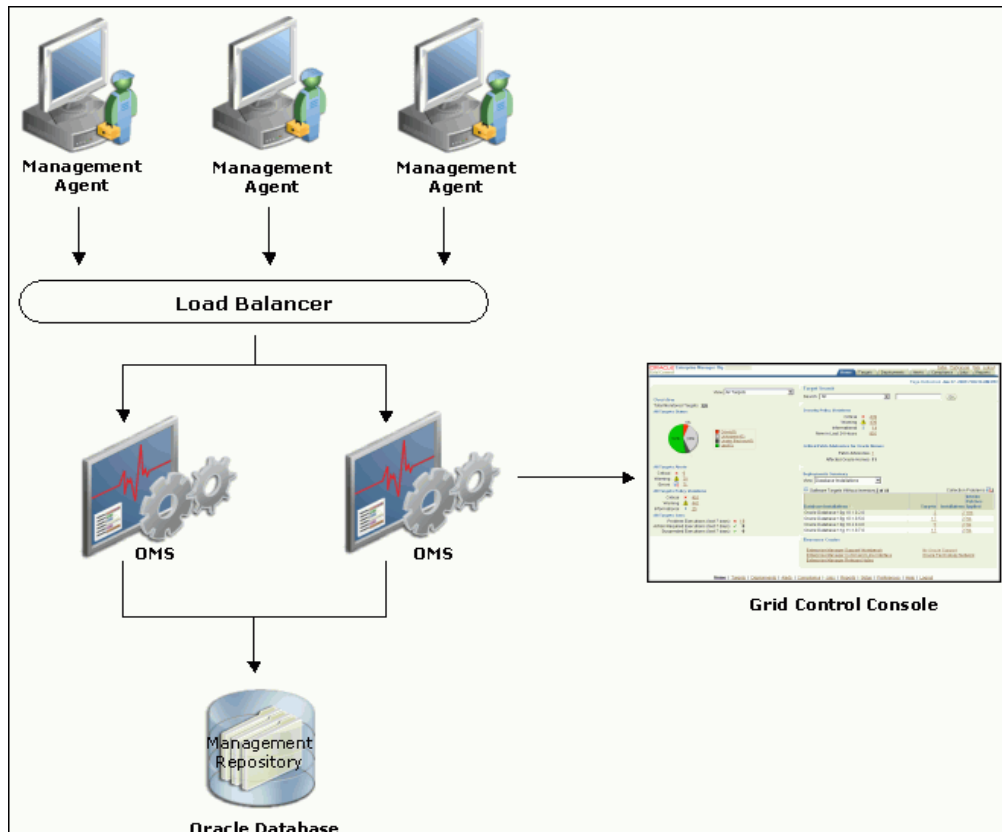

After installing Enterprise Manager Grid Control, what you see is the Grid Control Console, the user interface that displays information about the health of the monitored targets. However, internally, OMS orchestrates with Management Agents to discover targets, monitor and manage them, and store the collected information in a repository for future reference and analysis.

To summarize, Enterprise Manager Grid Control has the following core components:

**Table 3–1 Enterprise Manager Grid Control Components**

Component	Definition
Oracle Management Agent ( <i>Management Agent</i> )	Management Agent is an integral software component that is deployed on each monitored host. It is responsible for monitoring all the targets running on those hosts, communicating that information to the middle-tier Oracle Management Service, and managing and maintaining the hosts and its targets.

**Table 3–1 (Cont.) Enterprise Manager Grid Control Components**

Component	Definition
Oracle Management Service (OMS)	OMS is a J2EE Web application that orchestrates with Management Agents to discover targets, monitor and manage them, and store the collected information in a repository for future reference and analysis. OMS also renders the user interface for the Grid Control console. OMS is deployed to the application server that is installed along with other core components of Enterprise Manager Grid Control.
Oracle Management Repository (Management Repository)	<p>Management Repository is the storage location where all the information collected by the Management Agent gets stored. It consists of objects such as database jobs, packages, procedures, views, and tablespaces.</p> <p>Technically, OMS uploads the monitoring data it receives from the Management Agents to the Management Repository. The Management Repository then organizes the data so that it can be retrieved by OMS and displayed in the Grid Control console. Since data is stored in the Management Repository, it can be shared between any number of administrators accessing Grid Control.</p> <p>Management Repository is configured in Oracle Database. This Oracle Database can either be an existing database in your environment or a new one installed along with other core components of Enterprise Manager Grid Control.</p>
Enterprise Manager Grid Control Console	Enterprise Manager Grid Control Console is the user interface you see after you install Grid Control. From the Grid Control console, you can monitor and administer your entire computing environment from one location on the network. All the services within your enterprise, including hosts, databases, listeners, application servers, and so on, are easily managed from one central location.

## Key Features

Enterprise Manager enables users to manage their applications from top to bottom - from monitoring service levels to proactively isolating business exceptions before they escalate to addressing issues at any level in the IT stack. Users can manage the entire application lifecycle with comprehensive application quality management and compliance solutions. The key features are listed below:

- [System Monitoring](#)
- [Managing Groups](#)
- [Job System](#)
- [Information Publisher](#)
- [Compliance Management](#)
- [Extending Enterprise Manager](#)
- [Managing Targets](#)

## System Monitoring

Enterprise Manager provides comprehensive, flexible, easy-to-use monitoring functionality that supports the timely detection and notification of impending IT problems across your enterprise. For applications built on Oracle, Enterprise Manager offers the most comprehensive monitoring of the Oracle Grid environment - from Oracle Database instances to Oracle Real Application Clusters to Oracle Application Server Farms and Clusters.

For example, Enterprise Manager's monitoring functionality is tightly integrated with Oracle Database 10g manageability features such as server-generated alerts. These alerts are generated by the database itself about problems it has self-detected. Server-generated alerts can be managed from the Enterprise Manager console and include recommendations on how problems can be resolved. Performance problems such as poorly performing SQL and corresponding recommendations that are generated by the database's self-diagnostic engine, called Automatic Database Diagnostic Monitor (ADDM), are also captured and exposed through the Enterprise Manager console. This allows Enterprise Manager administrators to implement ADDM recommendations with ease and convenience.

Enterprise Manager comes with a comprehensive set of performance and health metrics that allow monitoring of key components in your environment such as applications, application servers, databases, as well as the back-end components on which they rely, such as hosts, operating systems and storage.

The Management Agent on each monitored host monitors the status, health, and performance of all managed components (also referred to as *targets*) on that host. If a target goes down, or if a performance metric crosses a warning or critical threshold, an alert is generated and sent to Enterprise Manager and to Enterprise Manager administrators who have registered interest in receiving such notifications.

Some metrics have predefined limiting parameters called thresholds that cause alerts to be generated when metric values exceed these thresholds. An alert indicates a potential problem indicating that a warning or critical threshold for a monitored metric has been crossed. An alert can also be generated for various availability states such as:

- Target is down.
- Oracle Management Agent monitoring the target is unreachable.

When an alert is generated, you can access details about the alert from the Enterprise Manager console. Administrators can be automatically notified when an alert is generated, and corrective actions can be automatically set up to resolve an alert condition.

*Corrective actions* allow you to specify automated responses to alerts. They ensure that routine responses are automatically executed, thereby saving administrators time and ensuring problems are dealt with before they noticeably impact users.

All monitoring information is accessed via the Enterprise Manager console, providing quick views into the health of your monitored environment.

The Enterprise Manager console home page shown in the figure below gives you an at-a-glance view of the overall status of your monitored environment. As shown in the following figure, the home page summarizes key monitoring areas such as availability across all managed targets, open alerts, policy violations, and recent problems with job executions. Links on this page allow you to drill down to detailed performance information.

The Resource Center is your central access point to Enterprise Manager documentation as well as the comprehensive technical resources of the Oracle Technology Network (OTN).

The screenshot displays the Oracle Enterprise Manager 11g Grid Control interface. The top navigation bar includes links for Home, Targets, Deployments, Alerts, Compliance, Jobs, Reports, My Oracle Support, Setup, Preferences, Help, and Logout. The main content area is divided into several sections:

- Overview:** Shows 'Total Monitored Targets: 103'. A pie chart indicates the status of all targets: Up (60, 66%), Unknown (20, 22%), and Down (11, 12%).
- All Targets Alerts:** Lists 28 Critical, 22 Warning, and 28 Errors.
- All Targets Policy Violations:** Lists 387 Critical, 224 Warning, and 14 Informational violations.
- All Targets Jobs:** Shows 0 Problem Executions, 0 Action Required Executions, and 0 Suspended Executions (all for the last 7 days).
- Target Search:** A search bar with a dropdown menu set to 'All' and a 'Go' button.
- Security Policy Violations:** Lists 396 Critical, 231 Warning, and 12 Informational violations. It also shows 644 new violations in the last 24 hours.
- Recommended Security Patches:** Shows 'Security Recommendations: Unavailable' and 'My Oracle Support Credentials: Not Set'. A note states: 'Patch Recommendations are not available. My Oracle Support credentials are required.'
- Deployments Summary:** Shows 'View: Database Installations' and 'Software Targets Without Inventory: 1 of 9'. A table lists database installations with columns for 'Targets', 'Installations', and 'Patches Applied'.
 

Database Installations	Targets	Installations	Patches Applied
Oracle Database 10g 10.1.0.5.0	2	1	No
Oracle Database 11g 11.1.0.6.0	0	1	No
Oracle Database 11g 11.2.0.1.0	6	4	No
- Resource Center:** Provides links to Enterprise Manager Support Workbench, Oracle Technology Network, Enterprise Manager Command Line Interface, and Enterprise Manager Release Notes.

The bottom navigation bar includes links for Home, Targets, Deployments, Alerts, Compliance, Jobs, Reports, My Oracle Support, Setup, Preferences, Help, and Logout.

## Managing Groups

Today's IT operations staff are often responsible for managing a great number of components, such as databases, application servers, hosts, or other components. The Enterprise Manager Group Management System lets you combine components (called targets in Enterprise Manager) into logical sets, called *groups*. By organizing targets into groups, you can manage and monitor many components as one. The group management system enables you to organize, manage, and effectively monitor the potentially large number of targets in your enterprise.

The group management system allows you to:

- View a summary status of the targets within the group.
- Monitor outstanding alerts and policy violations for the group collectively, rather than individually.
- Monitor the overall performance of the group through performance charts.
- Perform administrative tasks, such as scheduling jobs for the entire group, or blacking out the group for maintenance periods.

## Job System

The Enterprise Manager Job System provides the capacity to automate routine administrative tasks and synchronize components in your environment so you can manage them more efficiently. A *job* is a unit of work that you define to automate commonly-run tasks. One of the advantages of jobs is that you can schedule a job to start immediately or start at a later date and time. You have the option to have the job run once or at a specific interval.

The Enterprise Manager Job System serves a dual purpose:

- Provides for the automation of many administrative tasks, for example, backup, cloning, and patching

- Allows users to create their own jobs using their own custom OS and SQL scripts
- Enterprise Manager provides predefined job tasks for database targets and deployments. A *job task* is used to contain predefined, unchangeable logic—for example, patch an application, back up a database, and so on. In addition to predefined job tasks, you can define your own job tasks by writing code to be included in OS and SQL scripts. In addition to submitting jobs to individual targets, you can submit jobs against a group of targets. Any job that you submit to a group is automatically extended to all its member targets and takes into account the membership of the group as it changes.

## Information Publisher

Information Publisher, Enterprise Manager's powerful reporting framework, makes information about your managed environment available to audiences across the enterprise. Reports are used to present a view of enterprise monitoring information for business intelligence purposes, but can also serve an administrative role by showing activity, resource utilization, and configuration of managed targets. IT managers can use reports to show availability of sets of managed systems. Executives can view reports on availability of applications (such as corporate email) over a period of time.

The reporting framework allows you to create and publish customized reports. Intuitive HTML-based reports can be published via the Web, stored, or e-mailed to selected recipients. Information Publisher comes with a comprehensive library of predefined reports that allow you to generate reports out-of-box without additional setup and configuration. The key benefits of using Information Publisher are:

- Provides a framework for creating content-rich, well-formatted HTML reports based on Management Repository data.
- Out-of-box reports let you start generating reports immediately without any system configuration or setup.
- Ability to schedule automatic generation of reports and store scheduled copies and/or e-mail them to intended audiences.
- Ability for Enterprise Manager administrators to share reports with the entire business community: executives, customers, and other Enterprise Manager administrators.

Information Publisher provides you with a feature-rich framework that is your central information source for your enterprise.

## Compliance Management

To have your enterprise run efficiently, it must adhere to standards that promote the best practices for security, configuration, and storage. Once these standards are developed, you can apply and test for these standards throughout your organization; that is, test for compliance. *Compliance* in this context is the conformance to standards, or requirements, or both.

Using Enterprise Manager, you can test the conformance of your targets for security standards, and configuration and storage requirements. By continually testing your systems, services, and targets, you are ensuring the best possible protection and performance for your system.

Enterprise Manager provides two types of compliance management: policies and policy groups. Together these define the optimal configurations of systems.

Policies and policy groups are similar in purpose, that is, they both provide rules against which managed entities are evaluated. However, there are differences:

- Rules within a policy group are managed as a set. They are viewed, maintained, evaluated, and reported, in the context of a policy group.
- Policies are evaluated as a set. Policies are viewed, maintained, and evaluated as standalone entities. Out-of-box policies and user-defined policies are available.

Whether you use the out-of-box policies and policy groups or customize policies and policy groups to meet your particular system requirements, any deviations to your systems or applications are reported. Examples of deviations include inappropriate settings and incorrect system configurations. Using the Information Publisher feature, you can view reports of any policy violations and policy group reports.

## Extending Enterprise Manager

Enterprise Manager allows you to monitor and manage a variety of components out-of-the-box.

Enterprise environments consist of a wide variety of components: OS platforms, hardware, software, network, and storage devices. All of these components work in concert to deliver critical information and functionality required to keep enterprise operations performing optimally and providing information to make important business decisions. While Oracle Enterprise Manager allows you to monitor and manage a variety of components out-of-the-box, you may want to monitor third party components or custom applications specific to your environment.

In addition, you can use the same mechanism used by Oracle and its partners to extend Enterprise Manager to monitor custom components via modular Management Plug-ins. The Management Plug-ins allow you to seamlessly monitor and manage non-Oracle components from the Grid Control console by providing an easy way to specify new classes of components for Enterprise Manager to monitor. Once you have created the new Management Plug-in, you can use the Enterprise Manager console to deploy the new plug-in throughout your enterprise.

Extending Enterprise Manager for monitoring additional components provides the following benefits:

- **Centralize management information in a single console:** When deployed, components defined by the Management Plug-in automatically appear in the Grid Control console. Being able to monitor all targets in your environment provides a consolidated view of your entire enterprise, thus allowing you to monitor and manage all components from a central point.
- **Extend Enterprise Manager's monitoring and management features to non-Oracle components:** Newly added components automatically inherit Enterprise Manager's powerful monitoring and management features, such as: alerts, policies, blackouts, monitoring templates, groups/systems, configuration management, and enterprise reporting.
- **Comprehensive Service-Level Management:** By managing all of your enterprise components with Enterprise Manager, you can more fully utilize the Service-Level Management features offered in Enterprise Manager.

**Tip:** For more details, see  
<http://www.oracle.com/technology/products/oem/extensions/index.html>

## Managing Targets

Enterprise Manager can monitor, administer, maintain, and manage different types of targets. For more details on these targets, refer to the following chapters:

- [Enterprise Configuration Management](#)
- [Host and Third-Party Target Management](#)
- [Database Management](#)
- [Change Management for Databases](#)
- [Service Management](#)
- [Middleware Management](#)
- [Identity Management](#)
- [Oracle Beehive Management](#)
- [Lifecycle Management](#)
- [Virtualization Management](#)



---



---

# Enterprise Configuration Management

This chapter explains how Enterprise Manager Grid Control simplifies the monitoring and management of the deployments in your enterprise, and contains the following section and subsections:

- [Hardware and Software Configurations](#)
- [Accessing Configuration Pages in Grid Control](#)
- [Configuration Change Console](#)
- [Application Change Console](#)

## Hardware and Software Configurations

You can use Grid Control to view, save, track, compare, and search the configuration information stored in the Management Repository for individual hosts, databases, application servers, clients, and non-Oracle systems in the entire enterprise.

## Collected Configurations

Enterprise Manager collects configuration information for all hosts and the managed targets on those hosts that have a running Management Agent. The agent periodically sends the configuration information to the Management Repository over HTTP or HTTPS, allowing you to view up-to-date configuration information for your entire enterprise through Grid Control.

**Table 4–1** *Collected Configurations for Various Targets*

Target Type	Collected Configuration Information
Host <sup>1</sup>	<ul style="list-style-type: none"> <li>■ Hardware (includes memory, CPU, I/O device, and network information)</li> <li>■ Operating system (includes installed patches and patch sets)</li> <li>■ Oracle software (includes installed products and their components, patch sets, and interim patches applied using OPatch)</li> <li>■ Other software (includes all software registered with the operating system)</li> </ul>

**Table 4–1 (Cont.) Collected Configurations for Various Targets**

Target Type	Collected Configuration Information
Database <sup>2</sup>	<ul style="list-style-type: none"> <li>■ Database and instance properties</li> <li>■ Initialization and System Global Area parameters</li> <li>■ Tablespace, datafile, and control file information</li> <li>■ Redo logs, rollback segments, and high availability information</li> <li>■ Licensing information</li> </ul>
Application Server	<ul style="list-style-type: none"> <li>■ Installation type and version</li> <li>■ Repository information</li> <li>■ URLs (for Management Agent and Application Server Control)</li> <li>■ Component information (includes HTTP Server, OC4J, and Web Cache)</li> <li>■ OPMN information (includes ports, SSL information, and log levels)</li> </ul>
Client <sup>3</sup>	<ul style="list-style-type: none"> <li>■ Hardware</li> <li>■ Operating system (includes properties, file systems, patches)</li> <li>■ Software registered with the operating system</li> <li>■ Network data (includes latency and bandwidth to the Web server)</li> <li>■ Client-specific data that describes configuration for the browser used to access the client configuration collection applet</li> <li>■ Other client-oriented data items</li> </ul>
Non-Oracle Systems	<ul style="list-style-type: none"> <li>■ Hardware details including vendor, architecture, CPU, and I/O device information.</li> <li>■ Operating system details including name, version, software and package lists, kernel parameters, and file system information.</li> <li>■ OS Registered software including product name, vendor, location, and installation time.</li> </ul>
Enterprise <sup>4</sup>	Summary views for hardware, operating systems, Oracle Databases, Oracle Application Servers, and Oracle Collaboration Suite.

[Table 4–3](#) contains details on these summary views.

<sup>1</sup> The default collection period for host configuration information is 24 hours.

<sup>2</sup> The default collection period for database configuration information is 12 hours.

<sup>3</sup> Refer to "[Client Configurations](#)" in this chapter for more information.

<sup>4</sup> Refer to "[The Enterprise Configuration](#)" in this chapter for more information.

## Viewing Configurations

Using Grid Control, you can perform the following actions for targets such as hosts, databases, application servers, and clients:

- View the last collected and saved configuration
- Save configurations to a configuration file or to the Management Repository
- Search collected configuration data

- View the history of configuration changes
- Compare configurations (refer to "[Comparing Configurations](#)" in this chapter for more detailed information)

**See Also:** Grid Control online help for the pages described in [Table 4-2](#)

**Table 4-2 Viewing Configurations for Various Targets**

Target Type	Instructions for Viewing Configuration
Host	From the Home page for that host, click the <b>Configuration</b> subtab. For a Fusion Middleware target like WebLogic Server, navigate to the WebLogic Server Home page and select Configuration > Last Collected option from the menu.
Database	From the Database Home page, click the <b>Maintenance</b> subtab, then click the <b>Last Collected Configuration</b> link under Software Deployments, Configuration.
Application Server	From the Application Server Home page, click the <b>Administration</b> subtab, then click the <b>Last Collected Configuration</b> link under Configuration.
Client	From the Deployments tab, click the <b>Client Configurations</b> link.
Enterprise	From the Deployments tab, select a summary view from the <b>View</b> list under Deployment Summary. Summary views are provided in <a href="#">Table 4-3</a> .

Figure 4–1 Host Configuration Page

**ORACLE Enterprise Manager 10g**  
Grid Control

Home Targets Deployments Alerts Policies Jobs Reports

Collaboration Suites | Hosts | Databases | Application Servers | Web Applications | Services | Systems | Groups | All Targets

Host: iilnrn05.us.oracle.com

Latest Data Collected From Target Oct 13, 2005 5:37:46 AM PDT Refresh

Home Performance Targets Configuration

Save History Compare Configuration Compare to Multiple Configurations(Job)

**Hardware**

System Configuration **i686**  
Hardware Provider **Intel Based Hardware**  
Number of CPUs **2**  
Memory Size (MB) **5897**  
Related Link [Hardware Details](#)

**Operating System**

Operating System **Red Hat Enterprise Linux AS release 3 (Taroon Update 4) 2.4.21 27.ELsmp (32-bit)**  
Packages **1117**  
Related Link [Operating System Details](#)

**Oracle Software**

Product	Oracle Home	Installation Time
Oracle Application Server 10g 10.1.2.0.0	/home/sabbun/OraMid (OraMid)	Oct 5, 2005 12:28:59 AM
Oracle Application Server 10g 10.1.2.0.0	/home/sabbun/installs/oracluster (oracluster)	Oct 4, 2005 6:11:16 PM
Oracle Application Server 10g 10.1.2.0.2	/home/sabbun/midtier (oracleas_midtier)	Aug 31, 2005 1:35:11 AM
Oracle Application Server Integration B2B 10.1.2.0.2	/home/sabbun/OraMid (OraMid)	Oct 10, 2005 2:27:56 AM
Oracle Application Server Integration InterConnect 10.1.2.0.2	/home/sabbun/OraMid (OraMid)	Oct 5, 2005 3:39:52 AM
Oracle Application Server Integration InterConnect 10.1.2.0.2	/home/sabbun/midtier (oracleas_midtier)	Aug 31, 2005 3:13:42 AM
Oracle BPEL Process Manager 10.1.2.0.0	/home/sabbun/installs/oracluster (oracluster)	Oct 4, 2005 6:44:55 PM
Oracle Database 10g 10.1.0.2.0	/private/sabbun/databases/db10 (db_home) ⚠	Apr 19, 2005 6:32:32 PM
Oracle Management Agent 10.2.0.1.0	/scratch/sabbun/mm9_agent/agent10g (agent10g1)	Oct 7, 2005 6:03:50 AM

Related Link [Search Oracle Products Installed in Oracle Homes](#)

**OS-Registered Software**

Product	Vendor	Location	Installation Time
4Suite 0.11.1-14	Red Hat, Inc.	N/A	Mar 8, 2005 10:32:09 AM
a2ps 4.13b-28	Red Hat, Inc.	N/A	Mar 8, 2005 10:32:04 AM
acl 2.2.3-1	Red Hat, Inc.	N/A	Mar 8, 2005 10:31:18 AM
alchemist 1.0.27-1	Red Hat, Inc.	N/A	Mar 8, 2005 10:32:05 AM
alchemist-devel 1.0.27-1	Red Hat, Inc.	N/A	Mar 8, 2005 10:38:46 AM
am-utils 5.6.0.9-2	Red Hat, Inc.	N/A	Mar 8, 2005 10:36:33 AM
amanda 2.4.4p1-0.3E	Red Hat, Inc.	N/A	Mar 8, 2005 10:36:32 AM
amanda-client 2.4.4p1-0.3E	Red Hat, Inc.	N/A	Mar 8, 2005 10:36:35 AM
amanda-devel 2.4.4p1-0.3E	Red Hat, Inc.	N/A	Mar 8, 2005 10:38:51 AM
amanda-server 2.4.4p1-0.3E	Red Hat, Inc.	N/A	Mar 8, 2005 10:46:30 AM

Related Link [Search OS-Registered Software Installed on Hosts](#)

Home Performance Targets Configuration

## Comparing Configurations

Grid Control gives you the tools to perform comparisons between configurations of the same target type. These comparisons are useful for quickly finding similarities and differences between two or more configurations.

You can compare:

- Two configurations in the Management Repository
- Two saved configuration files
- One configuration to multiple configurations
- A configuration in the Management Repository to a saved configuration file

When two target configurations are compared, all categories of collected configuration information are included. Grid Control presents the summary results of the comparison in a tabular format. More detailed information is available by drilling down from those summary results.

Comparisons between multiple configurations must be performed using the Enterprise Manager Job System.

**See Also:** "About Comparisons" in the Grid Control online help

## The Enterprise Configuration

Grid Control offers several summary views of your enterprise that you can use to monitor the state of your host and target configurations. "Enterprise" refers to the complete set of hosts and targets for which configuration information is stored in the Management Repository. You can also search enterprise configuration information using predefined or custom searches.

### Viewing the Enterprise Configuration

Table 4-3 lists the available enterprise configuration summary views.

**Table 4-3 Enterprise Configuration Summary Views**

Summary View	Description
Hardware	Shows the different types of host hardware and the number of hosts using each hardware type. From the summary view, you can drill down to: <ul style="list-style-type: none"> <li>■ A list of hosts using each hardware type</li> <li>■ The operating system running on each host</li> </ul>
Operating Systems	Shows the different types of operating systems, the number of hosts running each type, and whether any operating system patches were applied. From the summary view, you can drill down to: <ul style="list-style-type: none"> <li>■ A list of hosts running each operating system</li> <li>■ A list of the operating system patches, and whether or not they have been applied</li> </ul>
Database and Fusion Middleware Installations	Shows the different versions of Oracle Databases or WebLogic Servers, respectively, the number of targets and installations for each version. From the summary view for each database or WebLogic Server version, you can drill down to: <ul style="list-style-type: none"> <li>■ A list of the instances</li> <li>■ A list of the installations and Oracle home directories</li> <li>■ More information about the unique interim patches</li> </ul>
Collaboration Suite Installations	Shows the different versions of Oracle Collaboration Suite components, the number of targets and installations for each version, and whether or not any interim patches were applied using OPatch. From the summary view, you can drill down to more information about Oracle Collaboration Suite components.

**See Also:** "Viewing the Enterprise Configuration" in the Grid Control online help

### Searching the Enterprise Configuration

In some cases, you may want to search your enterprise configuration to get answers to specific questions about your enterprise, such as:

- Which hosts have not had operating system patch 105181-05 installed?
- Which hosts have an Oracle version 9.0.1.0.0 database installed, and in what Oracle home directories are those databases installed?

Enterprise configuration searches query the enterprise configuration views in the Management Repository to find configuration information that satisfies the specified search criteria.

Enterprise Manager provides two types of enterprise configuration searches:

- **Predefined Searches**

Although these searches are predefined, you can modify the search criteria for each search, allowing you the flexibility to create specific search queries. Based on your search criteria, Grid Control creates the SQL query that searches the enterprise configuration views in the Management Repository.

Enterprise Manager provides the following predefined enterprise configuration searches:

- Search Oracle products, patch sets, and interim patches installed in Oracle homes
- Search software registered with the host operating system
- Search initialization parameter settings and setting changes
- Search tablespaces, datafiles, and recommended database settings
- Search database feature usage
- Search host operating system components, patches, property settings, and property changes
- Search host operating system and hardware summaries
- Search host file systems and network interface card configurations
- Search policy library
- Search VM Server configuration data
- Search Application Server configuration data
- Search WebLogic Managed Server configuration data

- **User-Defined Searches**

With a user-defined search, you specify the SQL query that searches the enterprise configuration views in the Management Repository. If you do not want to create the entire SQL query yourself, you can choose one of the predefined searches, make changes to the search criteria, then click **Search Using SQL** to display the SQL query that is executed. You can execute the query, view the results, then modify it and execute it again until it returns the desired results.

**See Also:** "Searching the Enterprise Configuration" in the Grid Control online help

### **Viewing the Enterprise Configuration History**

Enterprise Manager collects configuration information for a target and stores it in the Oracle Management Repository. Tracking historical changes to configurations is useful as it can help you diagnose problems.

Targets interact with each other and changes in one target may affect the behavior of other related targets. Tracking historical changes can be very important when trying to diagnose a problem as it provides clues as to which changes might have affected it. Hence, it is important to be able to see historical changes for a number of related targets.

The Enterprise Configuration History option allows you to see a merged history of a number of related targets for a specific period. For example, if the current value of a property seems to affect the value of another, the historical data helps you see when the value was last changed and what other values changed at that time.

## Client Configurations

A "client" represents an end-user or customer system—a system that is not part of your own IT infrastructure. A "client configuration" represents the configuration data collected about the end-user's system. These configurations differ from the internal deployments that you manage using Grid Control.

The Client System Analyzer (CSA) application allows Web server administrators to collect and analyze data from end-user systems. The client data is collected by an applet, diagnosed, and sent back to the CSA application. You can either use the CSA application that comes pre-installed with Grid Control, or you can deploy CSA independently to your Web server.

### Client System Analyzer in Grid Control

Using the pre-installed application allows you to collect client data without having to set up a separate Web server. The Management Agents collect, analyze, and upload the client data to the Management Repository. End users do not need login credentials to access Grid Control. Example usage scenarios include:

- End-users who call the Help Desk may be asked to navigate to the Out-Of-Box CSA page so that their system information is uploaded. The Technical Support Representative can then review the system information and offer solutions.
- The client's application can be changed to provide an "Upload my system information" link to the Client System Analyzer in the Grid Control application. The link can specify certain configuration parameters, such as the URL to return to after the Client System Analyzer runs.
- The client's application can be modified to redirect its users to the Client System Analyzer in the Grid Control page during login or at other points in the application. Collected information can then be used from within Grid Control to obtain various bits of information about the client systems. Examples include most popular browser versions, or systems that do not have a necessary Operating System patch applied or do not have enough RAM.

### Client System Analyzer Deployed Independently

CSA can be deployed independently to any J2EE-capable Web server. This deployment strategy is appropriate when:

- Clients accessing CSA cannot reach or have limited access to a Grid Control deployment; for example, due to a firewall.
- Further customization to the CSA application is required, such as:
  - Custom rules can be supplied to the CSA application so that the end users have immediate feedback as to whether their systems satisfy certain constraints.
  - The behavior of the applet can be changed to collect additional information or to present end users with additional or different user interfaces.
  - The load on the Management Service Web servers needs to be reduced.

Both pre-installed and standalone types of deployments assign a configurable identifier called a Client Configuration Collection Tag to every client configuration collection. After the client configuration data has been collected by the client configuration collection applet and written to the Web server directory specified by the CSA application, you must configure Grid Control to collect the client configuration data and upload it to the Management Repository.

**See Also:** "Viewing a Client Configuration" in the Grid Control online help

"Configuring Enterprise Manager to Collect Client Configurations" in the Grid Control online help

## Accessing Configuration Pages in Grid Control

To access the configuration pages in Grid Control, click the **Deployments** tab, then click the links found under the Configuration section:

- Search
- Compare Configurations
- Compare to Multiple Configurations (Job)
- View Saved Configurations
- Import Configuration
- Host Configuration Collection Problems
- Refresh Host Configuration
- Configuration History

These links take you to pages where you can search, view, and compare configurations for your various targets.

## Configuration Change Console

Enterprise Manager Configuration Change Console supports best practices policies by enabling you to validate user actions against established IT Controls, thereby helping to reduce unauthorized change and uncontrolled access attempts made to the IT infrastructure. By automatically monitoring critical applications and infrastructure components for changes, and then comparing detected changes to planned changes, the software can track activity, generate reports, trigger alert notifications, and identify policy violations.

Used as part of your IT compliance effort, the Configuration Change Console ensures adherence to internal controls supporting essential systems by monitoring, managing and auditing changes against corporate best practices policies. Although the products focus on IT control validation and compliance, they may also support other essential IT operations, including:

- **Monitoring Change:** Providing visibility into change in the infrastructure, and linking ticketed changes to actual changes.
- **Troubleshooting/Forensics:** Identifying the changes that could have contributed to outages or problems and putting safeguards in place. You even can archive critical configuration files so you can roll back problematic changes.



- Overall IT Management: Identifying trends in CPU utilization, disk utilization, and so on, for critical applications, and alerting administrators to potential problems before they cause outages.

You decide which infrastructure components you want to monitor. The Configuration Change Console collects data from those components according to the data collection rules you have defined, generates notifications according to those rules, and maintains a database of the changes made to those infrastructure components. You can then explore and analyze that data for compliance or for forensic purposes, displaying information in a time-based information model to accurately track exactly what changed and when. The user interface offers graphical visualization tools and the ability to drill down to specific devices, time intervals, and events. The solution provides both packaged and ad hoc reporting capabilities. For more details, see *Configuration Change Console User's Guide*.

## Application Change Console

Enterprise Manager Application Configuration Console is a configuration management tool that allows you to see and manage your infrastructure configuration data in new ways. It automates the IT configuration processes required to build and maintain complex infrastructure configurations for Java EE based enterprise applications throughout their entire lifecycle.

Application Configuration Console enables you to:

- Centralize your configuration management by loading configuration data from the various servers and systems into Application Configuration Console.
- Increase efficiency by arranging the configuration data to match responsibilities and workflow. Users can see configuration information arranged in a way that makes sense to them.
- Understand large and complex infrastructures by seeing visual representations of the systems in each environment side by side.
- Save time by comparing system configurations - down to the property level - with differences highlighted automatically.
- Make changes to configurations and then provision those changes out to the remote systems.
- See changes over time with automatic version tracking. Compare versions and roll back to previous versions if necessary.
- Enforce configuration standards by tracking configurations for any changes.
- Standardize deployments by creating new system configurations that are based on your **gold standards** and deploying those configurations to new systems.
- Allow others to view change report histories and comparisons from their Web browsers.

The tracking feature lets you see alerts and receive e-mail when there are changes to configurations or to external resources. To cut down on "false positives," that is, raising alerts unnecessarily, tracking employs a comparison strategy that considers all metadata set on assets and configurations, to see if it affects the outcome of the comparison. For example, if a container or element has the metadata `COMPARISON_IGNORE_CONTAINER_INSTANCE` set to `TRUE`, the comparison disregards the container or element.

The comparison feature lets you compare two or more containers or configurations to quickly identify configuration differences, which are often the source of problems in applications. You can compare individual configurations or entire container trees. You can also compare an asset or configuration with the external resources to see any differences between the Application Configuration Console data and the external resources.

Save a comparison so that you can easily run it again. Saved comparisons contain a list of the containers that are being compared and a list of ignored properties. You can share a saved comparison with other users so that they can run the comparison at any time. Saved comparisons can also be run from the browser-based Web Reports interface. Schedule a saved comparison to be run on a recurring basis. Comparison alerts result from differences detected during scheduled comparisons.

When Application Configuration Console detects differences, you have the capability to synchronize changes by either writing out the changes made in Application Configuration Console (provision) or reloading the external files (update).

---

---

## Host and Third-Party Target Management

Today's IT infrastructure has evolved to include a variety of server platforms from different vendors such as Red Hat, SUSE, Sun, IBM, HP, and Windows. A typical enterprise also contains hardware components and applications from a number of vendors to run services, provide storage, perform load balancing, and control IP traffic.

Out-of-box, Enterprise Manager allows you to centrally manage more than just your Oracle infrastructure:

- Monitor and maintain the operating system and hardware for the hosts running your Oracle software.
- Monitor IBM and Oracle application servers and clusters, F5 Server Load Balancers, Network Appliance Filers.

This chapter contains the following major sections:

- [Host Management](#)
- [Third-Party Target Management](#)

### Host Management

With the array of available server platforms, it becomes more and more difficult for system administrators to maintain the operating systems and hardware for the server, or host, on which Oracle software runs. With Grid Control, as soon as a Management Agent is deployed to the host, Grid Control automatically starts monitoring alert and configuration information for that machine. System administrators—and anyone who requires host information, such as DBAs managing databases on those hosts—benefit from Grid Control's host management feature.

---

---

**Note:** To access the host management pages in Grid Control, do the following:

1. Click the **Targets** tab.
2. Click the **Hosts** subtab.

This will display all the monitored hosts in your enterprise. Click the **Help** link on any page to access the Grid Control online help system.

---

---

Host management allows users to:

- Analyze performance trends for host hardware to predict future performance
- Measure service levels by monitoring host performance in real-time

- Validate software and hardware configuration across the enterprise

## Monitoring Hosts

Like for other managed targets, Grid Control's full suite of monitoring features, including alerts, custom notifications, blackouts, corrective actions, monitoring templates, and more, are available for hosts.

### Host Home Page

The Host Home page provides an overview of the status and vital statistics for each host that is part of the Grid Control environment.

Grid Control consolidates the relevant host information into a convenient single-screen Host Home page. You can see the availability, key configuration information, and outstanding alerts, as well as other pertinent information about the host. Convenient links allow you to view all the metrics collected for the host, change the thresholds as appropriate, or directly log in to the host to perform administrative actions.

Using the Host Home page, you can do the following:

- Drill down to view detailed metrics
- View operating system, hardware, and other configuration information for the host
- View policy violations and alerts for the host
- Analyze the job activity
- Determine whether there are outstanding patch advisories
- Determine the last security evaluation of the host
- Navigate to other pages to help you investigate the health of the host

Figure 5–1 Host Home Page

The screenshot displays the Oracle Enterprise Manager 10g interface for a specific host. The main navigation bar includes Home, Targets, Deployments, Alerts, Compliance, Jobs, and Reports. The host name is dadvmm0630.us.oracle.com. The page is divided into several sections:

- General:** Shows the host status as 'Up', last booted 'Before 5 Days 11 Hours (Jan 10, 2009 2:34:33 AM (UTC-08:00))', 1 logon, and 100% availability. A 'Black Out' button is present.
- Configuration:** Lists system details: Operating System (Enterprise Linux), Hardware Platform (i386), IP Address (10.229.149.34), 1 CPU, 4000 MB Memory Size, and 96.46 GB Local File Systems.
- Alerts:** A table with columns for Metric Name, Severity, Message, Alert Triggered Value, and Last Checked. It currently shows 'No alerts found'.
- Policy Violations:** Shows 'Current 24' distinct policies violated and a compliance score of 76%.
- Security:** Shows the last security evaluation on Jan 15, 2009, with a compliance score of 68%.
- Critical Patch Advisories:** Shows 'Current 0' advisories. A warning indicates that patch advisory information may be stale due to unconfigured Oracle Support credentials.
- Job Activity:** Shows execution statistics for jobs within the last 7 days: Problem (0), Action Required (0), Suspended (0), Scheduled (0), and Running (0) executions.
- Related Links:** A list of links for further actions like Access, Alert History, All Metrics, Blackouts, Deployments, Execute Host Command, Log File Alerts, Metric and Policy Settings, Monitoring Configuration, Net Services Administration, Open Telnet Session, Privilege Delegation Setting, Remote File Editor, Reports, Storage Details, Target Properties, and User-Defined Metrics.

## Host Performance Page

The Host Performance page provides an overview of the utilization statistics (CPU, Memory, Disk I/O, and Program Resource Utilization) for an individual host. Choose one of these options from the **View** menu. With this information, system administrators can determine whether resources need to be added or redistributed. You can also view the top processes consuming the most CPU or Memory and take appropriate action.

The performance metrics that are collected out-of-box for the host span several different categories: CPU Usage (including idle, wait, and user times), Disk Activity (including Average Disk I/O rate), and Network Interface Activity, among others. You can also view real-time metrics such as buffer activity.

Using the Performance page, you can:

- View various utilization charts by selecting an option in the **View** menu. Related metrics are also displayed under the charts. Click a metric link to view the metric in more detail.
- View the processes that are using the most CPU or memory resources.
- View performance data in real-time, or historical data over defined periods.

Figure 5–2 Host Performance Page

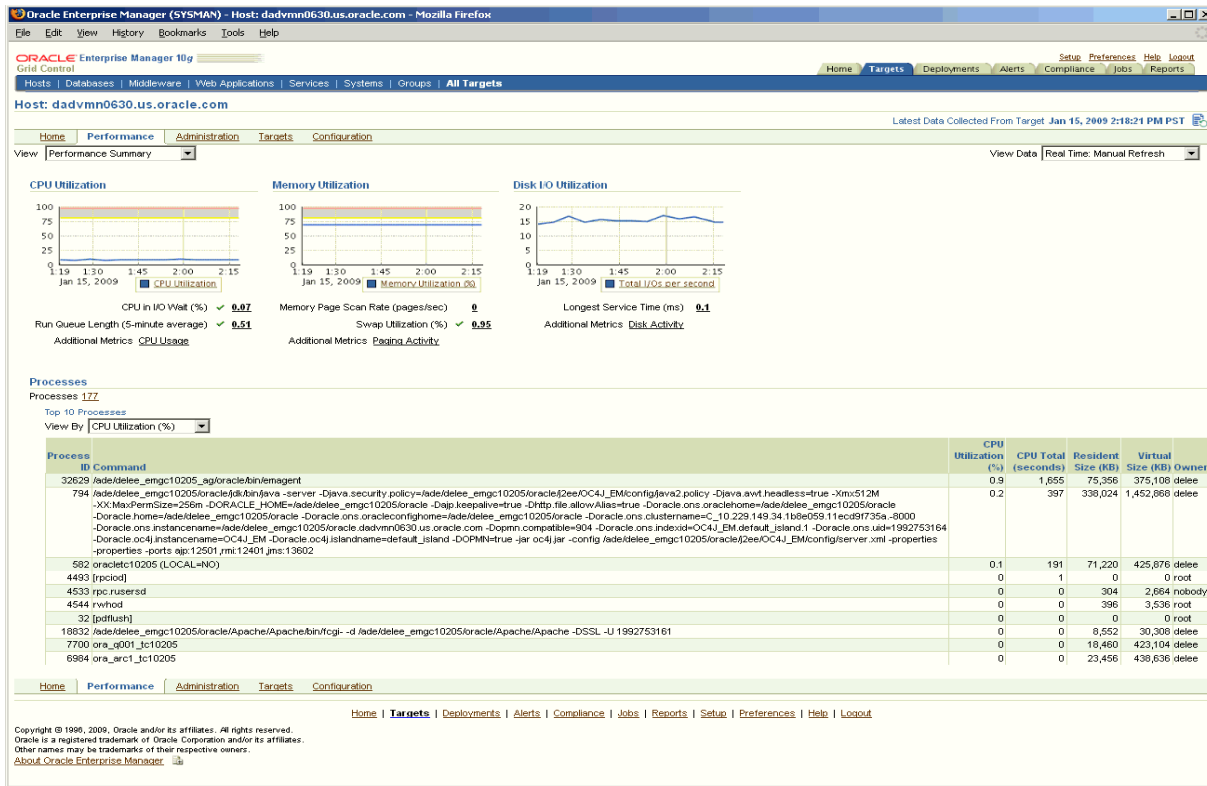

## Host Configuration Page

The Host Configuration page lists not only operating system and hardware configuration information, but all Oracle software and operating-system registered software on the host as well. You can also compare configurations for single or multiple hosts.

**See Also:** "Hardware and Software Configurations" in Chapter 4, "Enterprise Configuration Management"

## Operating System Details

Enterprise Manager surfaces key operating system-level information for hosts. You can obtain general information about the operating system, such as the distributor and the version. You can also drill-down for specific information such as system properties, file systems, and operating system-level packages. This information helps when troubleshooting performance problems that arise because of configuration issues.

**Note:** To access the Operating System Details page:

1. From the **Hosts** subtab, select a host target.
2. From the Host Home page, click the **Operating System Details** link under Configuration.

Figure 5–3 Host Operating System Details Page

ORACLE Enterprise Manager 10g  
Grid Control

Home | Targets | Deployments | Alerts | Policies | Jobs | Reports | Setup | Preferences | Help | Logout

Collaboration Suites | Hosts | Databases | Application Servers | Web Applications | Services | Systems | Groups | All Targets

Host [iilnrn05.us.oracle.com](#) >

Operating System Details Data Collected Oct 13, 2005 5:37:46 AM PDT

Host **iilnrn05.us.oracle.com** (History)

Operating System **Red Hat Enterprise Linux AS release 3 (Taroon Update 4) 2.4.21.27.ELsmp (32-bit)**

Vendor **Red Hat**

**General** | File Systems | Packages

Distributor Version **Red Hat Linux 3.2.3-47**  
Maximum Swap Space (MB) **8047.31**

**Operating System Properties**

Name	Source	Value
nameserver 1	/etc/resolv.conf	130.35.249.41
nameserver 2	/etc/resolv.conf	130.35.249.52
nameserver 3	/etc/resolv.conf	138.2.202.15
Maximum Swap Space (MB)	/sbin/sysctl	8047.31
abi.defhandler_coff	/sbin/sysctl	117440515
abi.defhandler_elf	/sbin/sysctl	0
abi.defhandler_lcall7	/sbin/sysctl	68157441
abi.defhandler_libcso	/sbin/sysctl	68157441
abi.fake_utsname	/sbin/sysctl	0
abi.trace	/sbin/sysctl	0
debug.kermltype	/sbin/sysctl	
debug.rpmarch	/sbin/sysctl	
dev.parpport.default.spintime	/sbin/sysctl	500
dev.parpport.default.timeslice	/sbin/sysctl	200
dev.raid.speed_limit_max	/sbin/sysctl	10000
dev.raid.speed_limit_min	/sbin/sysctl	100
dev.rtc.max-user-freq	/sbin/sysctl	64
fs.aio-max-pinned	/sbin/sysctl	393216
fs.aio-max-size	/sbin/sysctl	131072
fs.dir-notify-enable	/sbin/sysctl	1
fs.file-max	/sbin/sysctl	65536
fs.lease-break-time	/sbin/sysctl	45
fs.leases-enable	/sbin/sysctl	1
fs.nfs.nfs3_acl_max_entries	/sbin/sysctl	1024
fs.nfs.nlm_grace_period	/sbin/sysctl	0

Related Link [Search Operating System Property Settings on Hosts](#)

**General** | File Systems | Packages

Home | Targets | Deployments | Alerts | Policies | Jobs | Reports | Setup | Preferences | Help | Logout

The File Systems page includes information about the various mount points for the host, type of mount point, time of the mount, and the directory where the file system is mounted.

The Packages page lists all of the operating system packages installed on the host.

## Hardware Details

The Hardware Details page allows you to view the CPU, I/O, and Network Interfaces associated with the host. It also helps the user keep track of the hardware changes that occur over time. The type of operation (INSERT, UPDATE, or DELETE) and the category of the hardware that is updated are reflected on this page.

---

**Note:** To access the Hardware Details page:

1. From the **Hosts** subtab, select a host target.
  2. From the Host Home page, click the **Hardware Details** link under Configuration.
-

Figure 5–4 Host Hardware Details Page

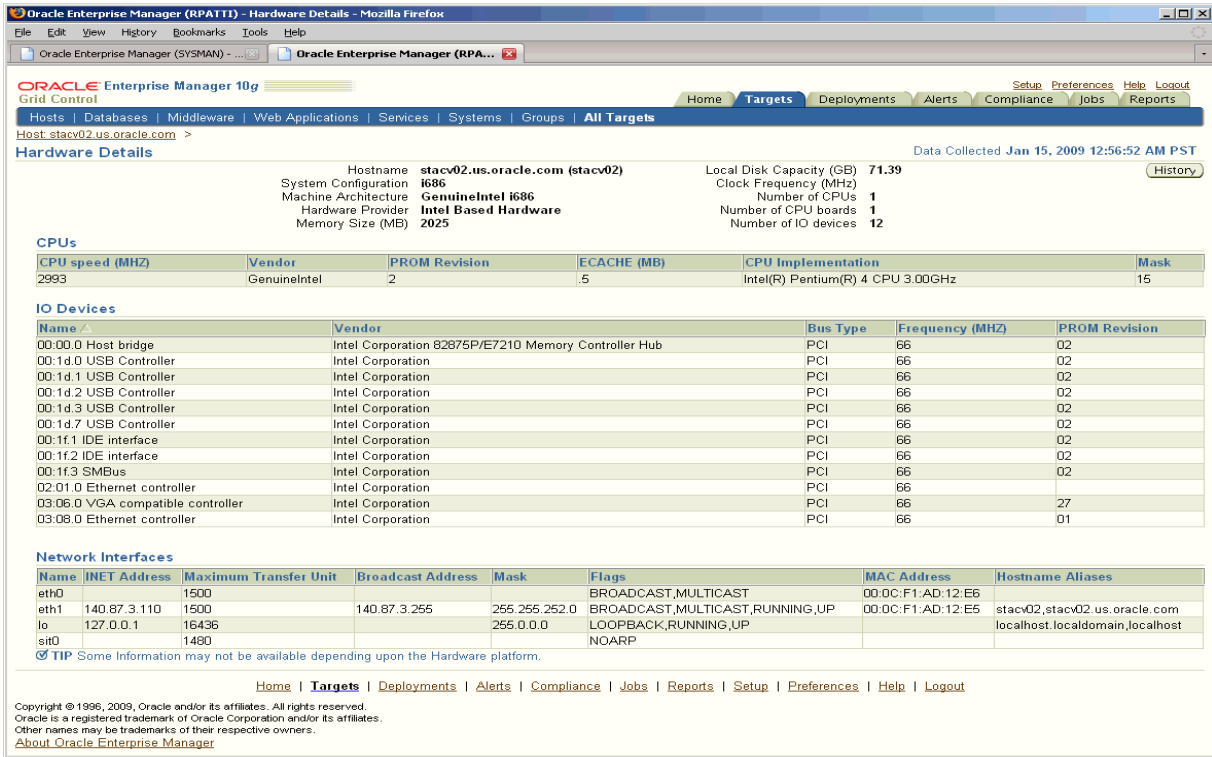

### Log File Monitoring

Grid Control monitors the log files for the occurrence of operator-specified patterns. Use this facility to monitor abnormal conditions recorded in the log files present on the host.

Log files are periodically scanned for the occurrence of desired patterns and an alert is raised when the pattern occurs during a given scan. During a scan, new content created since the last scan is searched for the occurrence of the desired patterns. Use this page to view, clear, and purge open alerts generated during log file monitoring.

**Note:** To access the Log File Alerts page:

1. From the **Hosts** subtab, select a host target.
2. From the Host Home page, click the **Log File Alerts** link under Related Links.

**See Also:** "Configuring Generic Log File Monitoring Criteria" in Grid Control online help

### Program Resource Utilization Monitoring

Enterprise Manager allows you to track resource use for programs and users. For example, you can track CPU usage by user, by program, or a combination of the two.

The Program Resource Utilization page provides a quick glimpse of the programs being monitored on this host. With this information, you can see trends in resource usage for:

- A specific program or set of programs



- A specific user or set of users
- A combination of programs and users

---

---

**Note:** To access the Program Resource Utilization page:

1. From the **Hosts** subtab, select a host target.
2. From the Host Home page, go to the **Performance** page.
3. From the Host Performance page, select **Program Resource Utilization** from the View menu.

You can also access the page from the All Metrics page for that host.

---

---

**See Also:** "Configuring Program Resource Utilization Monitoring Criteria" in Grid Control online help

### File and Directory Monitoring

Enterprise Manager monitors the files and directories for the operator-specified criteria on hosts running various versions of the UNIX operating system. The operator should configure the criteria for monitoring the desired files and directories.

---

---

**Note:** To access the File Directory Monitoring page:

1. From the **Hosts** subtab, select a host target.
  2. From the Host Home page, click the **All Metrics** link under Related Links.
  3. From the All Metrics page, select **File and Directory Monitoring** from the list of metrics.
- 
- 

**See Also:** "Configuring File and Directory Monitoring Criteria" in Grid Control online help

### Hardware Monitoring for Dell PowerEdge Systems

Hardware-specific monitoring is available out-of-box for Dell PowerEdge Linux hosts with Enterprise Manager. The following hardware health statistics can be monitored as part of the Dell PowerEdge Linux host target:

- Processor Status
- Memory Status
- PCI Device Status
- Power Supply Status
- System BIOS Status
- Fan Status
- Remote Access Card Status
- Temperature Probe Status

---

---

**Note:** To access the Hardware Monitoring page for Dell PowerEdge Systems:

1. From the **Hosts** subtab, select a host target.
  2. From the Host Home page, click the **All Metrics** link under Related Links.
  3. From the All Metrics page, select the metric you want to monitor from the list of metrics.
- 
- 

**See Also:** "Enabling Hardware Monitoring for Dell PowerEdge Linux Hosts" in Grid Control online help

## Storage Resource Tracking

Tracking the storage resource allocation and usage is essential to large IT departments. Unallocated and underutilized storage can be put to better use. Historical trends at a business entity-level enable you to plan for future growth.

Storage Details are relevant to Enterprise Manager targets that are associated with one or more hosts. In particular:

- Summary attributes presented are rolled up for one or multiple associated hosts.
- Storage Details helps in tracking storage resource allocation and usage for one host or a group of hosts, and tracks historical usage trends.
- A host is associated with a group either through explicit membership, or implicit membership inherited through a group member target.

---

---

**Note:** To access the Storage Details page:

1. From the **Hosts** subtab, select a host target.
  2. From the Host Home page, click the **Storage Details** link under Related Links.
- 
- 

The Storage Details page displays the following charts:

- **Overall Utilization:** Shows summary attributes that provide a system-level view of storage resource utilization.
- **Provisioning Summary:** Shows allocation-related summary attributes for File Systems, ASM, Volumes, and Disks for the associated hosts.
- **Consumption Summary:** Shows usage-related summary attributes for Databases and File Systems.

The Disks option on the Storage Details page shows the allocated and unallocated storage for all the disks and disk partitions on a host. All disks are listed, including virtual disks from external storage systems such as EMC Storage Array.

Figure 5–5 Host Storage Details Page

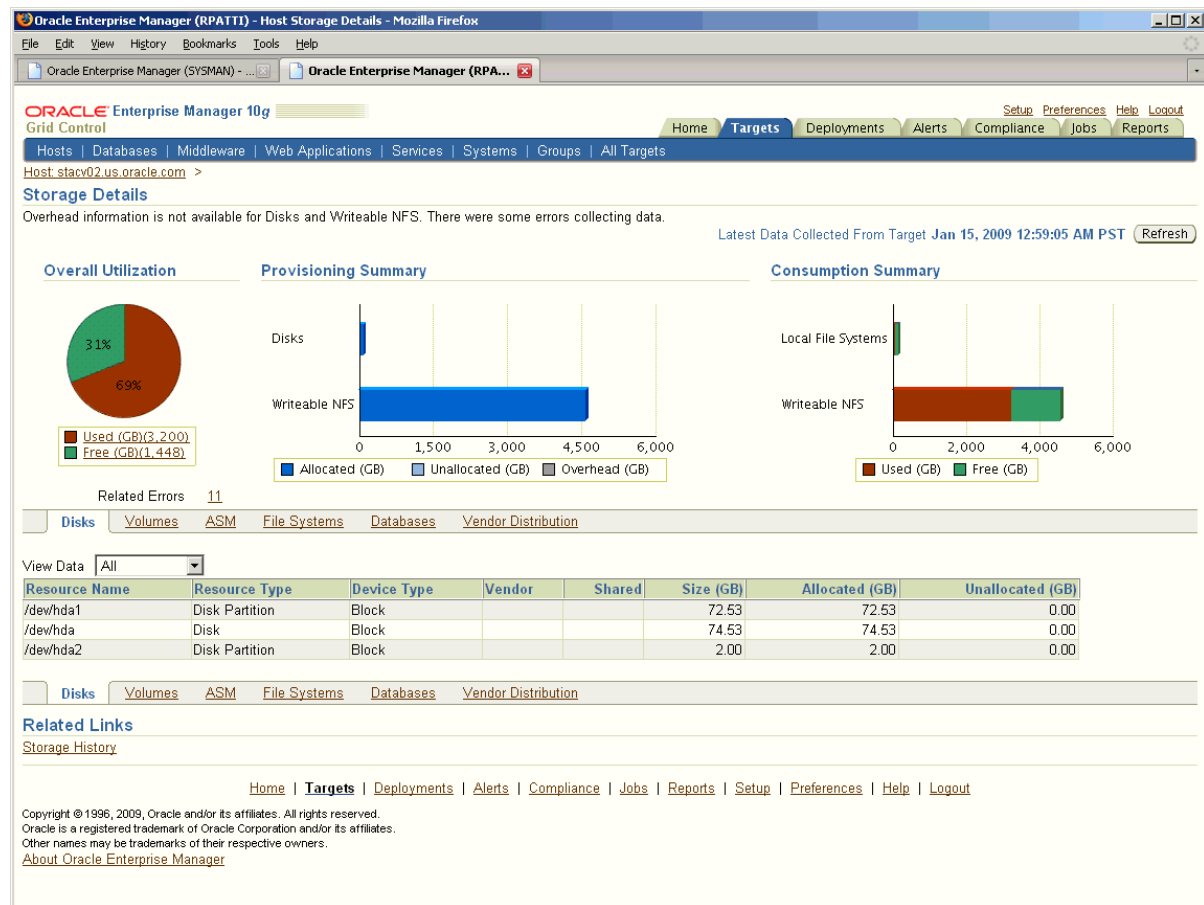

## Host Administration

In addition to the general Grid Control features and tools described in the "[Overview of Enterprise Manager Grid Control](#)" chapter, you can administer your hosts using the Host Administration tab and Grid Control's tools designed for host management.

### Linux Host Administration

Linux host administration features for RedHat (RHEL4) and SuSE Linux (sles9) provide you the ability to administer the most important host functions easily and quickly. Operators with the appropriate privileges can set up and administer the following OS features:

- System Services
  - Start and stop individual services — Facilitates upgrading and troubleshooting applications and databases
  - Configure services to run at boot time — Ensures that all your applications and dependent services are available after every reboot
  - Assign system services to run levels — Assures appropriate behaviors to assist in maintenance and trouble-shooting
- Network Setup

- NFS Client Configuration — Allows you to configure access to storage resources
- Network Card Configuration — Enables you to rapidly establish connectivity to the network to get your application service running quickly
- View and edit host name lookup tables (/etc/hosts) — Allows you to set-up and edit host names to identify new services to the network

---

---

**Note:** To access the Host Administration page:

1. From the **Hosts** subtab, select a Linux host target.
  2. From the Host Home page, click **Administration**.
- 
- 

### Execute Host Command

With the appropriate privileges, you can execute non-interactive host commands remotely over the network, as well as view and edit text files. The Execute Host Command page enables you to type operating system commands against one or more hosts, or all the hosts in a group, enabling you to perform multiple administrative operations at the same time.

---

---

**Note:** To access the Execute Host Command page:

1. From the **Hosts** subtab, select a host target.
  2. From the Host Home page, click the **Execute Host Command** link under Related Links.
- 
- 

### Job System

You can leverage the Job System to run operating system commands for your host. From the Execute Host Command page, use the "Load from Job Library" option to search the Job Library for existing jobs that you can reuse.

From the Load from Job Library page, click the icon in the **Load** column of any row to return to the Execute Host Command page, loading the complete context of the library job in that row. The complete context includes the host command, OS script, targets, and credentials.

---

---

**Note:** To access the Load from Job Library page:

1. From the Execute Host Command page, click the **Switch to Multiple Target Mode** link.
  2. Click the **Load from Job Library** button.
- 
- 

### Remote File Editor

The Remote File Editor page enables you to view, edit, copy, and save text files present on the remote host target. For example, using this utility, you can update the contents of configuration files on the remote host.

---

---

**Note:** To access the Remote File Editor page:

1. From the **Hosts** subtab, select a host target.
  2. From the Host Home page, click the **Remote File Editor** link under Related Links.
- 
-

## Managing Host Deployments

Use Grid Control's deployment management tools to:

- View and compare host configurations
- Perform automated patching for your hosts
- Deploy new hosts using the provisioning facility

**See Also:** ["Linux Host Patching" in Chapter 12, "Lifecycle Management"](#)

## Third-Party Target Management

Grid Control enables you to manage hardware and software from certain third-party vendors out-of-box. Most tools, functions, and features available for monitoring and administering Oracle targets can be used to manage other targets in your data center.

---

---

**Note:** Use Grid Control to manage your complete data center by developing Management Plug-ins for your managed targets. Refer to *Enterprise Manager Extensibility* for more information.

---

---

## Support for Third-Party Application Servers

With tools and features similar to managing Oracle Application Server targets, Grid Control allows you to monitor the following third-party application server targets, as well as the applications deployed on the servers:

- Oracle WebLogic Domains, Clusters, and Managed Servers
- IBM WebSphere Cells, Clusters, and Application Servers
- JBoss Partitions and JBoss Application Servers
- Microsoft Exchange Organizations, Routing Groups, and Servers

Oracle WebLogic Domains, IBM WebSphere Cells, and Microsoft Exchange Organizations represent logically-related groups of application server resources. Grid Control monitors them as composite targets, containing rolled-up information on the member targets that make up the group.

All the resources in a Oracle WebLogic Domain are centrally managed by the WebLogic Administration Server, and the resources in an IBM WebSphere Cell are managed by the Deployment Manager. The JMX fetchlets specific to each product environment communicate with the Oracle WebLogic Administration Server or IBM WebSphere Deployment Manager to collect the metric information for the individual application servers that make up the Domain or Cell, respectively. There is no need to deploy Oracle Management Agents to each application server node; as long as a Management Agent is locally or remotely deployed to the host on which the Administration Server or Deployment Manager resides, Grid Control can manage those targets.

The member targets that make up a Oracle WebLogic Domain are clusters and managed servers, and the member targets that make up an IBM WebSphere Cell are clusters and application servers. As for Microsoft Exchange Organization, the member targets are individual Microsoft Exchange Servers.

Oracle WebLogic Cluster, IBM WebSphere Cluster, JBoss Partition, and Microsoft Exchange Routing Group provide a high-availability application server environment. Grid Control monitors them as composite targets, containing rolled-up information on

the member targets that make up the group. The member targets for each of these targets are the application servers grouped under them.

Oracle WebLogic Managed Servers, IBM WebSphere Application Servers, JBoss Application Servers, and Microsoft Exchange Servers are used to deploy applications and other resources. They are all monitored as individual targets, much like Oracle Application Servers.

Grid Control also provides configuration management features for these third-party application servers. Using these features, you can view the configurations that were last collected, save configurations so that they can be referenced in the future for possible analysis or comparison, and compare configurations to examine specific configuration variations between two instances. You can also perform some out-of-box searches, for example, you can search one or more J2EE applications deployed in your third-party application server instances.

However, note that all these third-party application servers have to be manually added to Grid Control for monitoring purpose. Unlike Oracle Application Servers, these third-party application servers are not automatically discovered by Grid Control. You can use the Application Servers tab of the Grid Control console to add these targets.

Some of the features available for these third-party application server targets are:

- **Robust monitoring:** Automatic performance and availability monitoring with Oracle recommended settings, out-of-box notifications for critical alerts, J2EE application monitoring for clusters, J2EE services monitoring for JBoss application servers, historical collections, blackouts, monitoring of application-defined MBeans, and more.
- **Service management:** Transaction performance monitoring, end-user performance monitoring, system monitoring, dashboards, Root Cause Analysis, and more.
- **Group management:** Group-level roll-ups for monitoring and task automation, monitoring templates.
- **Reporting:** Out-of-box and user-defined reports for JBoss Application Server.
- **Policy violations:** Out-of-box and user-defined policies for Oracle WebLogic Managed Server.
- **Administration:** Process control for starting, stopping, and restarting Oracle WebLogic Managed Server and IBM WebSphere Application Server. Also, control for starting and stopping Channels of IBM WebSphere MQ targets.
- **Configuration Management:** Viewing, comparing, and searching configuration information related to these application servers.

**See Also:** "Managing Oracle WebLogic Servers", "Managing IBM WebSphere Application Server", "Managing JBoss Application Server", and "Managing Microsoft Exchange Server" in Grid Control online help.

## Support for Third-Party Plug-Ins

Much like the support offered for third-party application servers, Grid Control also supports third-party plug-ins like IBM WebSphere MQ Queue Manager and IBM WebSphere MQ Cluster.

IBM WebSphere MQ Cluster is a composite target that groups the IBM WebSphere MQ Queue Managers, and provides a high-availability environment. Grid Control

monitors them as logical targets and provides rolled-up information about the queue managers that make up the cluster.

IBM WebSphere MQ Queue Manager is monitored like any other application server target. You can monitor their status, be notified for critical alerts, access out-of-box reports and policies, and view a list of metrics and gauge their performance.

The other logical objects of IBM WebSphere MQ Queue Manager for which Grid Control collects metrics are Queues and Channels. For each of these logical targets, Grid Control provides a home page to help you monitor their status and performance.

**See Also:** "Managing IBM WebSphere MQ Queue Manager" and "Managing IBM WebSphere MQ Cluster" helpsets in Grid Control online help

## Network Appliance Filer

When you use Oracle Enterprise Manager to manage your Oracle environment, you can monitor not only your databases and application servers, but also supporting hardware, such as IP traffic controllers and storage devices.

Network Appliance Filers configured to use the ONTAP operating software (release 6.0 or later) are one type of storage device that can be managed out of the box. Network storage devices can be an important part of your Oracle environment. Use them to store and access large amounts of database and application data.

Similar to other managed targets, Grid Control's full suite of monitoring features are available for Network Appliance Filers. Key aspects of Network Appliance Filer monitoring are displayed as part of the Network Appliance-specific target pages, and include the following:

- Availability
  - Filer Target
  - Cluster Filer's Partner Status
- Storage Space Allocation and Usage Monitoring
  - Traditional and Flexible Volumes
  - Aggregates, Qtrees, and Snapshots
  - System Level Storage Capacity Summaries
- Performance Monitoring
  - CPU Utilization and NFS Statistics
  - NFS/CIFS Calls
  - Disk, Network, and Network Interface I/O
- Health Monitoring
  - Power Supplies, Fans, and NVRAM Batteries
  - Temperature and NFS/CIFS Bad Calls
  - Cluster Partner/Interconnect Status
  - Network Interface Status/Errors/Discards
  - Disk Failures and Spare Disks

**See Also:** "Overview of Adding a Network Appliance Filer" in Grid Control online help

## F5 Load Balancer Switches

In addition to monitoring the performance of your database, the effectiveness of your mid-tier applications, and the response time of your Web pages, Grid Control helps you monitor load balancer switches. Load balancer switches are an important part of any complex Web application environment, because they distribute user requests to the Web servers.

F5 BIG-IP Load Balancers from F5 Networks running OS version 4.2 PTF-06, or later, can be managed out of the box from Grid Control. The user interface allows you to navigate through the relationships that exist among the entities present in the switch.

As with other managed targets, Grid Control's full suite of monitoring features are available for F5 Load Balancer Switches. Key aspects of F5 Load Balancer Switch monitoring are displayed on the Load Balancer Switch-specific target pages, and include the following:

- Availability
  - Load Balancer Switch Target
  - Virtual and Real Server Status
- Performance Monitoring
  - Switch Level — CPU and Memory Utilization
  - Switch, Virtual Server, Server Group and Real Server Level — Bits In and Bits Out Rates, Connections Per Second
  - Physical Interface Level — Bits In and Bits Out Rates

**See Also:** "Overview of Adding a Load Balancer Switch" in Grid Control online help



---

---

## Database Management

This chapter introduces the concept of database management in the following sections:

- [Introduction to Database Management](#)
- [Monitoring Databases](#)
- [Administering Databases](#)
- [Managing Database Security](#)
- [Masking Sensitive Data for Non-production Use](#)
- [Maintaining Databases](#)
- [Additional Maintenance Features](#)
- [Monitoring Oracle Real Application Clusters](#)

### Introduction to Database Management

Database management involves the monitoring, administration, and maintenance of the databases and database groups in your enterprise. Enterprise Manager is the premier tool for managing your database environment.

With Enterprise Manager, you receive:

- A complete set of integrated features for managing Oracle Databases
- Unparalleled scalability that lets you manage a single database or thousands of instances
- An intuitive management product that leads the industry in ease of deployment and use

### Database Control Versus Grid Control

Enterprise Manager provides two separate consoles that you can use to monitor your database: Database Control and Grid Control.

- Database Control is the Enterprise Manager Web-based application for managing Oracle Database 11g Release 1 (11.1) and later. Database Control is installed and available with every Oracle Database 11g installation. From Database Control, you can monitor and administer a single Oracle Database instance or a clustered database.
- Grid Control is the Enterprise Manager console you use to centrally manage your entire Oracle environment. Within Grid Control, you access the multiple database targets using the **Targets** tab, then **Databases**.

## Database Home Page as the Management Hub

The Enterprise Manager Database Home page (Figure 6–1) shows important status and performance information about your database instance from a single source, including:

- A quick view of the status of the database and basic information about the database
- Relative CPU utilization of the Oracle host
- Amount of time the instance consumed using CPU and I/O, and the amount of time it consumed in bottlenecks
- Current response of the tracked set of SQL versus the reference collection response
- The number of Automatic Database Diagnostic Monitoring (ADDM) findings, the number of policy violations (Database Control only), and the Alert Log status
- Storage-related issues and recommendations for improved performance, and information about space violations and ADDM
- The most recent backup time and backup status
- Outstanding alerts and related alerts
- Rolled-up number of Oracle policy violations across all member targets in a system
- A quick view of database security
- Job executions that show the scheduled, running, suspended, and problem executions

Starting from the Database Home page, you can access additional details and management functions by drilling down through the user interface. In addition, the Database Home page provides a list of Related Links. From these links, you can perform activities such as editing metric thresholds, analyzing job activity and metric collection errors, and accessing a number of advisors to help you improve the performance of your database.

**See Also:** "Oracle Database Home Page" in the Enterprise Manager online help.

Figure 6–1 Database Home Page

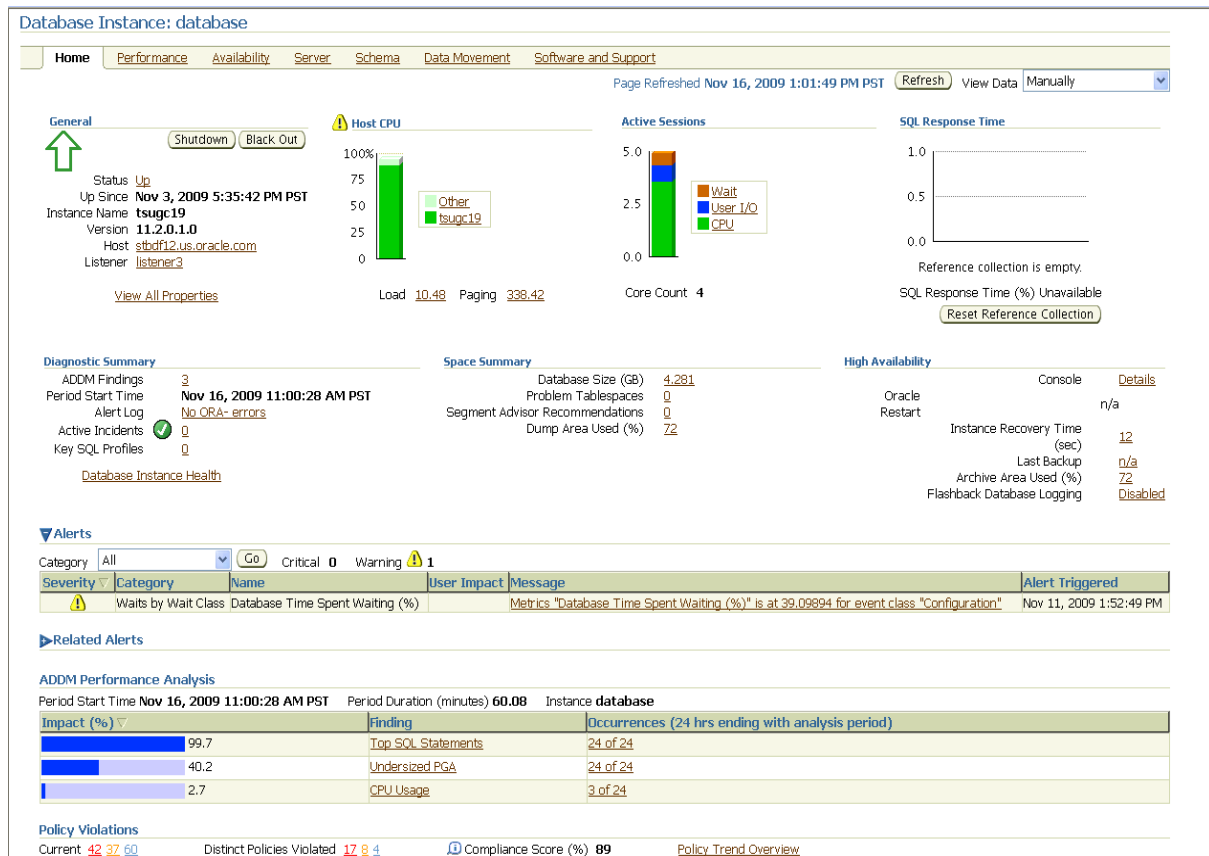

## Monitoring Databases

Comprehensive database monitoring enables you to identify the problem areas in your database environment that are degrading performance. After you have identified the areas to improve, you can tune your database's performance using the Enterprise Manager administration capabilities.

Enterprise Manager uses data from the Automatic Workload Repository (AWR) to display performance information and initiate database alerts. The user interface provides several real-time performance charts and drill-downs for the targets you manage. Both aggregate and instance-specific performance statistics are displayed using color-coded charts for easier viewing. To help you identify the source of a problem and resolve it, you can click a legend link next to a chart to display a detail page that provides comprehensive information.

The basic work flow in monitoring performance is to first go to the Database Performance page, which provides a high-level, comprehensive overview of important performance indicators, then diagnose problems either interactively or automatically.

**Tip:** For more information about monitoring databases not covered in the following sections, see the *Oracle Database 2 Day + Performance Tuning Guide* and the *Oracle Database Performance Tuning Guide*.

## Assessing Database Performance

Database tuning is much easier and more effective when all the information for an in-depth performance diagnosis is available on a single screen. On the Database Performance page (Figure 6–2), which is accessible from the Database Home page, you can quickly view performance data for the instance and its underlying host. Additionally, you can analyze trends for all critical performance metrics and compare the trends to those of other database instances.

The most direct method for investigating and diagnosing performance problems from this page consists of accessing the Automatic Database Diagnostic Monitor (ADDM). After you start your Oracle database, the Automatic Workload Repository (AWR) begins taking snapshots of database activity once every hour by default, and ADDM executes when the snapshots are collected. ADDM uses these snapshots to perform a top-down analysis of your database activity and then provide tuning recommendations.

Another method for investigating and diagnosing performance problems consists of observing which of the wait classes beside the Average Active Sessions chart appears to be consuming an excessive amount of time, shown as a spike above the Maximum CPU line, then drilling down for more information. This provides a way for you to visualize the data for which ADDM has made its recommendations.

Either method assists you in diagnosing and resolving problems. The first automated method produces textual findings, whereas the second interactive method produces graphical findings.

Figure 6–2 Database Performance Page



The charts on the Database Performance page display current and recent metric information on a common time axis that enables visual correlation of metrics. These charts provide context-sensitive drill-downs where you can find additional details for rapid problem diagnosis.

**Table 6–1 Performance Page Charts**

Chart	Description
Host: Runnable Processes	<p>This chart provides an overview of overall CPU usage. The Non-Database Host CPU value represents all other CPU work not done by this instance. The Instance Background CPU value represents Oracle processes that you cannot tune. The Instance Foreground CPU value represents any active work, such as database queries, that is tuneable.</p> <p>For information about the associated checkboxes that enhance the chart, see the online help for this page.</p>
Average Active Sessions	<p>This chart is the centerpiece of Oracle performance monitoring, and shows potential problems inside the database. It displays a profile of the amount of time sessions are either working or waiting to work in the database instance.</p> <p>Categories, called wait classes, show how much of the database is waiting for a resource, such as CPU or disk I/O. The chart displays the load on the instance and identifies bottlenecks in performance.</p> <p>For information about this chart, see the online help for this page.</p>
Throughput charts	<p>These charts show any contention that appears in the Average Active Sessions chart, and show how much work the database is performing for the user.</p>
I/O charts	<p>These charts show the following information:</p> <ul style="list-style-type: none"> <li>■ Latency for Synchronous Single Block Reads           <p>Most systems are performing satisfactorily if this chart shows that the latency is less than 10 msec.</p> </li> <li>■ Function Charts           <p>Show components such as RMAN, direct reads, and direct writes.</p> </li> <li>■ I/O Type Charts           <p>Show components such as small reads, small writes, large reads, and large writes.</p> </li> </ul>
Parallel Execution charts	<p>These charts show system metrics related to parallel queries. These charts show parallel queries that were waiting for a particular wait event that accounted for the highest percentages of sampled session activity.</p>
Services chart	<p>Shows the top services waiting for the corresponding wait event during the time period shown. Only active services are shown.</p>

The Additional Monitoring Links section enables you to access several related pages. Among those, the following pages have real-time diagnostic capabilities:

- Top Activity
- Top Consumers
- Instance Activity
- Historical SQL (appears only when View Data is set to Historical)

**See Also:** "Performance Page" in the Enterprise Manager online help

## Diagnosing Problems Interactively

You can manually diagnose problems using an interactive method by first investigating a wait class that you think may be problematic, then drilling down from there for either SQL details or session details. You can alternatively investigate all wait classes in one location and then drill down from there. The following sections explain these methods.

### Investigating a Wait Class

Wait class drill-downs enable you to investigate a specific wait class where it appears that time is accumulating. You can then determine whether the problem is caused by one or several SQL statements that are accumulating an unusual amount of time, or whether the problem is caused by one or several sessions.

The wait class drill-downs are called Active Sessions Waiting pages. The pages are sourced from the Active Session History (ASH), which samples session activity every second. It continuously records what is happening, such as which sessions are using CPU and which sessions are waiting on I/O.

Select a wait class link beside the Average Active Sessions chart to obtain detailed information for the wait class. For instance, if you click **User I/O**, the Active Sessions Waiting: User I/O page appears, as shown in [Figure 6-3](#).

**Figure 6-3** Active Sessions Waiting Page

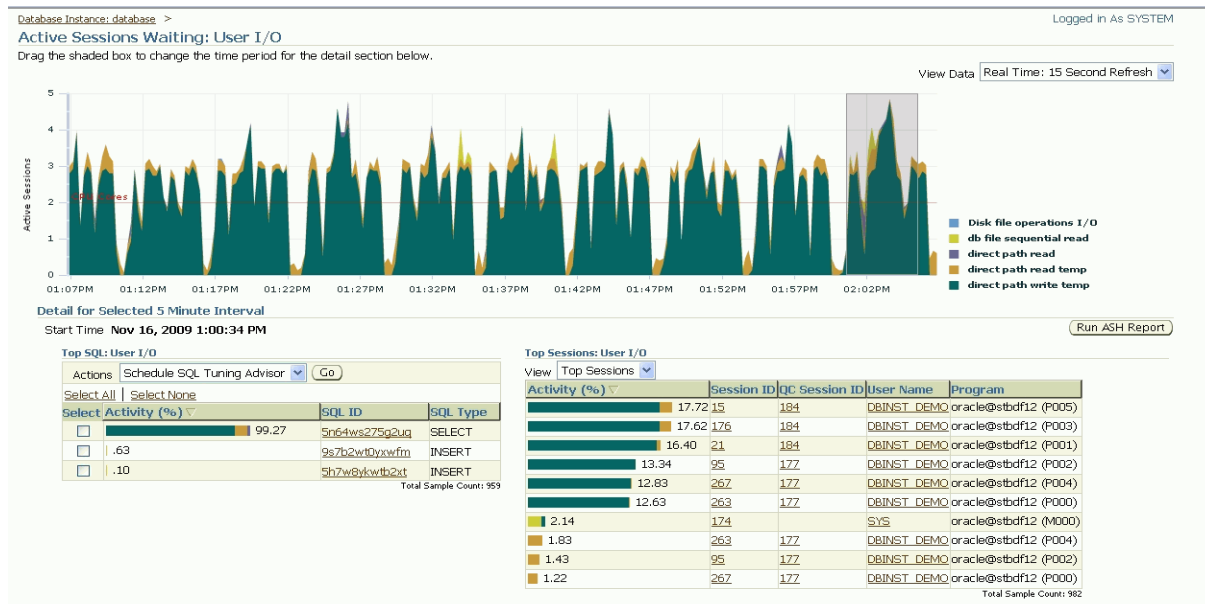

By default, the largest consumers of resources appear at the top of the detail tables. Look for skewed activity for either Top SQL or Top Sessions. If an excessive accumulation of activity appears to originate from an SQL source, you can click its associated SQL ID to go to the SQL Details page, which shows the SQL statement and activity. If excessive accumulation appears to originate from a session source, you can click its associated Session ID to go to the Session Details page, where you can abort the session if needed. You can also view the wait events associated with the session.

**See Also:** "Active Sessions Waiting Page" in the Enterprise Manager online help

**Viewing SQL Details** The SQL Details page, shown in [Figure 6–4](#), displays the SQL statement you select in the Active Sessions Waiting page. You can also:

- Examine the activity of this SQL statement over time.
- View SQL-level statistics.
- Investigate the SQL plan.
- Access any prior Tuning Advisor run.
- Schedule a Tuning Advisor run.

**Figure 6–4 SQL Details Page**

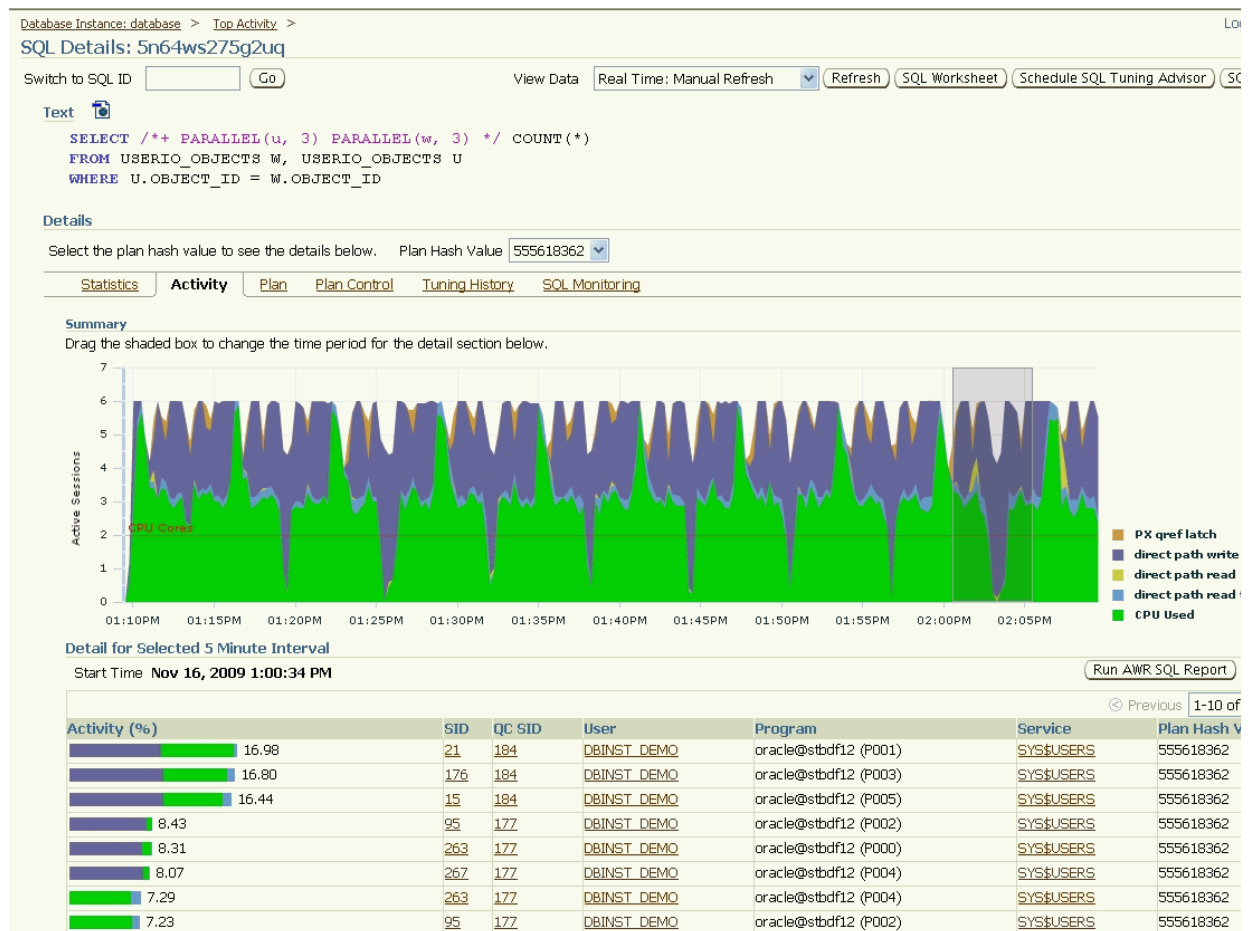

**See Also:** "SQL Details Page" in the Enterprise Manager online help

**Viewing Session Details** The Session Details page, shown in [Figure 6–5](#), displays the wait events associated with the session you selected in the Active Sessions Waiting page. You can also:

- View the current values for metrics associated with the current session.

- View the list of currently open cursors in the selected session, including their hash value and SQL text.
- View sessions that are blocking other sessions.

**Figure 6–5 Session Details Page**



**See Also:** "Session Details Page" in the Enterprise Manager online help

### Viewing Top Activity

The Top Activity page, shown in [Figure 6–6](#), is essentially the sum of all wait class drill-downs. The interface format is the same as the Active Sessions Waiting page, but rather than showing the average active sessions for a particular wait class, the Top Activity page shows the average active sessions for all wait classes. The page also shows the Top SQL and Top Sessions consumers for all wait classes. As with the Active Sessions Waiting pages, look for skewed activity for either Top SQL or Top Sessions.



Figure 6–6 Top Activity Page

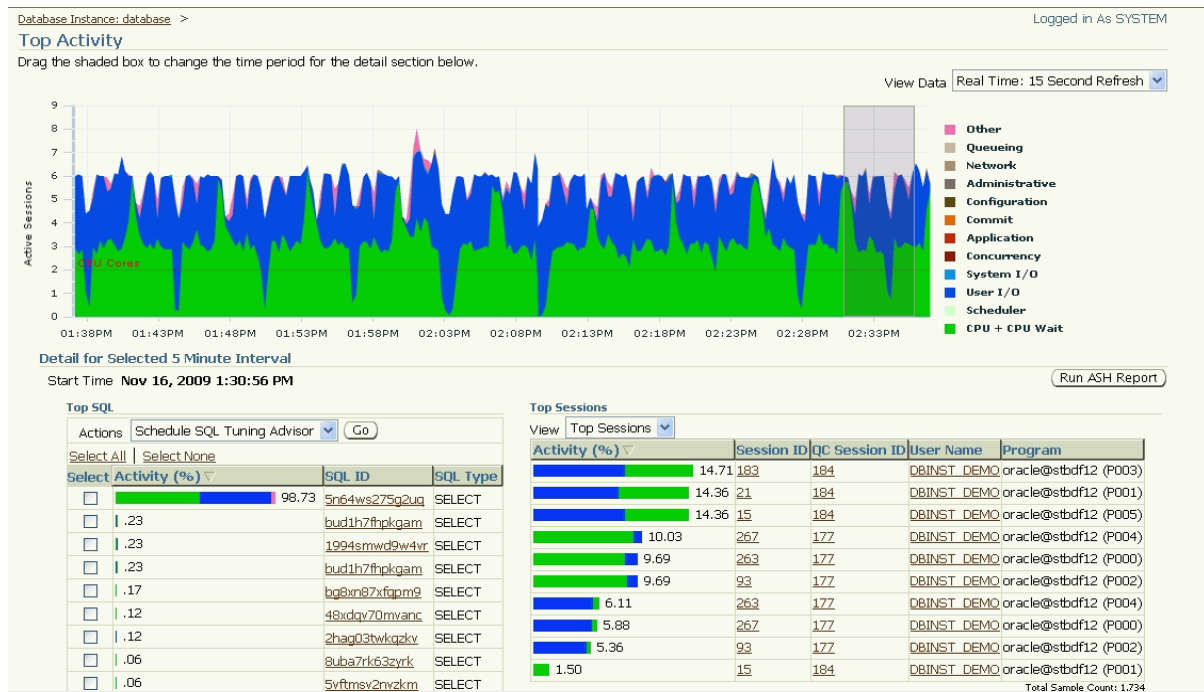

**See Also:** "Top Activity Page" in the Enterprise Manager online help

## Monitoring Real-time SQL

The real-time SQL monitoring feature of Oracle Database enables you to monitor the performance of SQL statements while they are executing. By default, SQL monitoring automatically starts when a SQL statement runs parallel, or when it has consumed at least 5 seconds of CPU or I/O time in a single execution.

Each row in the table in the Monitored SQL Executions page, shown in Figure 6–7, represents overall information and statistics for one execution of a SQL statement that Oracle has monitored. This table only shows the last few monitored executions, because the database server reclaims the space occupied by old monitoring data to store the monitoring data for new executions (that is, monitoring data is recycled).

Figure 6-7 Monitored SQL Executions Page

Database Instance: database > Logged in As SYS

Monitored SQL Executions

Active in last: All Refresh 10 seconds Stop Refresh

Status	Duration	SQL ID	User	Parallel	Database Time	IO Requests	Start	Ended	SQL Text
✓	46.0s	fskyn4u39manrv	SYS		44.6s	78K	Sat Jan 16, 2010	Sat Jan 16, 2010	DECLARE job
✓	8.0s	4u5zq7r9y690a	SYS		9.1s	27K	Sat Jan 16, 2010	Sat Jan 16, 2010	WITH NONTI
✓	33.0s	anxyyx2tjz3g	SYS		32.4s	48K	Sat Jan 16, 2010	Sat Jan 16, 2010	WITH TIME0
✓	20.0s	0a59tkkpx31vx	SYSTEM		19.5s	291	Fri Jan 15, 2010	Fri Jan 15, 2010	select output
✓	1.6m	gyfr7cpmbcx9r	SYS		1.6m	14K	Tue Jan 12, 2010	Tue Jan 12, 2010	DECLARE job
✓	14.0s	4ypznnny8pscjk	SYSTEM		12.6s	211	Mon Jan 11, 2010	Mon Jan 11, 2010	SELECT DBM
✓	6.0s	atkp0nywk0m99	SYSTEM		5.6s	649	Mon Jan 11, 2010	Mon Jan 11, 2010	DECLARE job
✓	8.0s	fskyn4u39manrv	SYS		8.2s	15K	Sat Jan 9, 2010	Sat Jan 9, 2010	DECLARE job
✓	4.0s	anxyyx2tjz3g	SYS		4.1s	9027	Sat Jan 9, 2010	Sat Jan 9, 2010	WITH TIME0
✓	13.0s	4ypznnny8pscjk	SYSTEM		13.3s	288	Thu Jan 7, 2010	Thu Jan 7, 2010	SELECT DBM
✓	59.0s	a0xx1k23fvg3z	SYSTEM		59.1s	742	Thu Jan 7, 2010	Thu Jan 7, 2010	DECLARE job
✓	13.0s	91pktudh76mzx	SYSTEM		13.8s	857	Thu Jan 7, 2010	Thu Jan 7, 2010	DECLARE job

To view detailed information on the execution of a SQL statement beyond what this page provides, you can either click the Status icon or right-click on any row of a column in the table to select the Monitored SQL Execution Details page, shown in Figure 6-8. You can click the View Report button to generate an active SQL Monitoring Report that provides the SQL text, detailed global information, and global statistics.

**Tip:** For more information, see "Real-time SQL Monitoring" in the *Oracle Database Performance Tuning Guide*.

Figure 6-8 Monitored SQL Execution Details Page

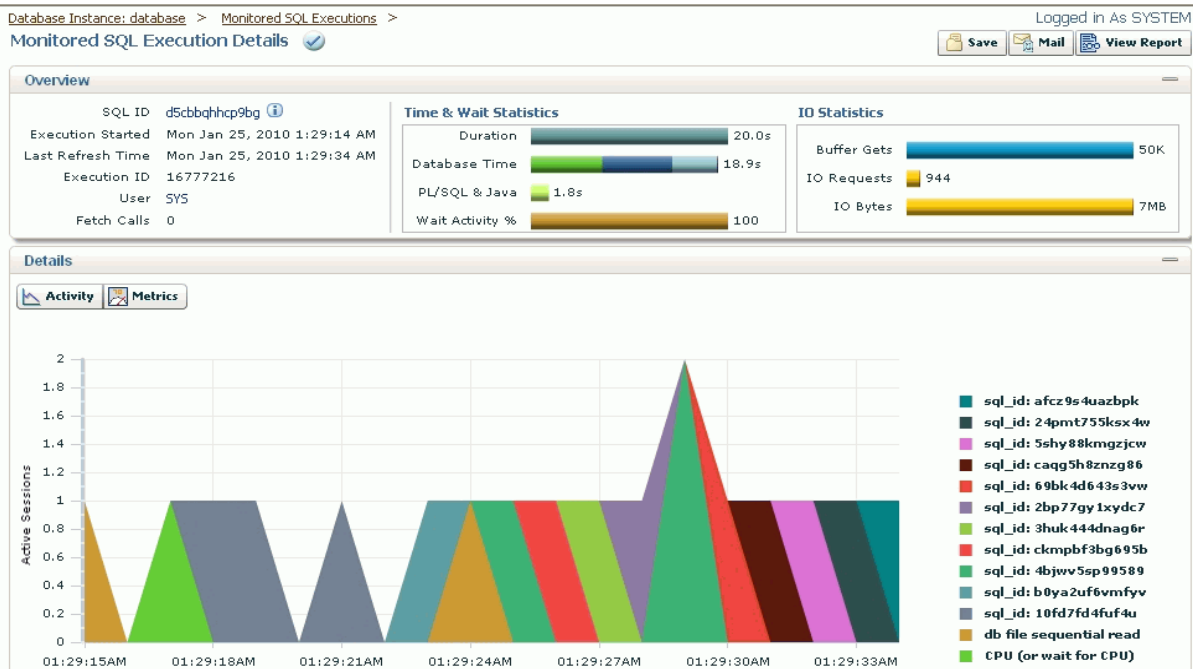

## Diagnosing Problems Automatically

As mentioned in [Assessing Database Performance](#), you can use the Automatic Database Diagnostic Monitor (ADDM) to automatically investigate and diagnose performance problems from either the Database Home page or the Database Performance page. Using regularly scheduled snapshots of the database activity, ADDM identifies the most resource-intensive components or operations, and determines whether or not these components or operations are acting as performance bottlenecks. If one or more problems have occurred, ADDM diagnoses these potential problems and provides advice, which may recommend that you run an advisor or change your database configuration.

You can view ADDM findings over a predetermined period of recent time or at the present time. You can view ADDM findings for the most recent time interval by clicking the **ADDM Findings** link in the Diagnostic Summary section of the Database Home page. You can also view ADDM findings for this interval by clicking the small ADDM icon below the Average Active Sessions chart in the Database Performance page. Either option displays the Automatic Database Diagnostic Monitor page, shown in [Figure 6–9](#). To determine ADDM findings at the present time, you can click the **Run ADDM** button on the Database Performance page.

By default, the database takes snapshots at 60-minute intervals. You can use the Automatic Workload Repository to change the snapshot interval, ranging from 10 minutes to 2 hours.

**Figure 6–9 Automatic Database Diagnostic Monitor (ADDM) Page**

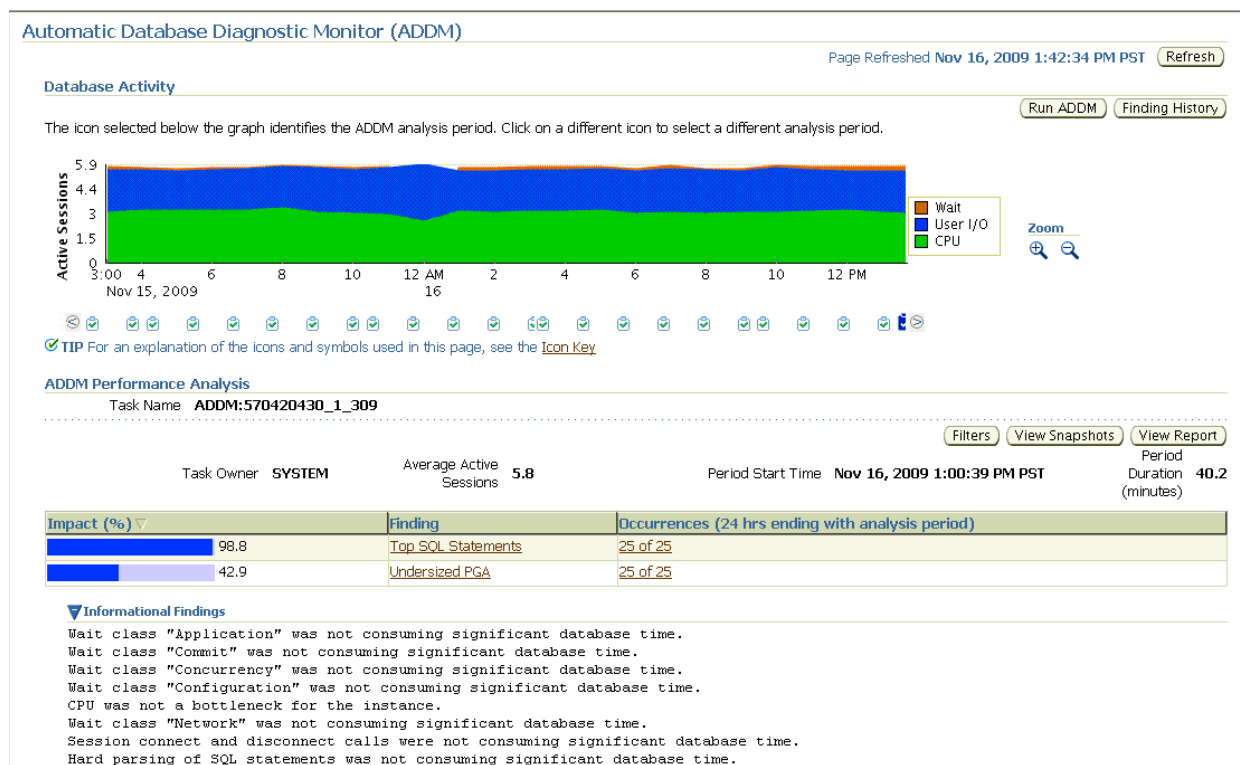

**See Also:** "Performance Finding Details Page" in the Enterprise Manager online help

## Using Additional Diagnostic Pages

Besides the primary diagnostic pages discussed above, other important secondary pages can assist you in diagnosing and correcting performance problems. The following sections discuss these diagnostic pages:

- Top Consumers
- Instance Activity
- Historical SQL

### Top Consumers

The Top Consumers link provides global summary information for the top database consumers of system resources. You can access detailed metrics data for a specific top consumer, such as sessions, services, modules, and clients. This enables you to pinpoint the most problematic areas on which to focus your database tuning efforts. [Figure 6–10](#) shows the Top Modules page of Top Consumers, where you can perform tasks such as enabling and disabling aggregation and SQL traces for the consumer. You can use an SQL trace to trace statistics of SQL statements, such as CPU time, elapsed time, and the Explain Plan.

**Figure 6–10** Top Consumers Top Modules Page

Database Instance: database > Logged in As SYSTEM

View Data Real Time: Manual Refresh ▼

**Top Consumers** Latest Data Collected From Target Nov 16, 2009 1:49:43 PM PST Refresh

Overview Top Services **Top Modules** Top Actions Top Clients Top Sessions

View Active Modules ▼

Enable Aggregation Disable Aggregation Enable SQL Trace Disable SQL Trace View SQL Trace File

Select All | Select None

Select	Service	Module	Activity (% for the last 5 minutes)	Aggregation Enabled	SQL Trace Enabled	Delta Elapsed Time (seconds)	Cumulative Elapsed Time (s)
<input type="checkbox"/>	SYS\$USERS	SQL*Plus	96.2	FALSE	FALSE		
<input type="checkbox"/>	SYS\$USERS	Admin Connection	1.9	FALSE	FALSE		
<input type="checkbox"/>	SYS\$USERS	Realtime Connection	.8	FALSE	FALSE		
<input type="checkbox"/>	SYS\$BACKGROUND	Unnamed	.5	FALSE	FALSE		
<input type="checkbox"/>	SYS\$USERS	emagent_AOMetrics	.2	FALSE	FALSE		
<input type="checkbox"/>	SYS\$USERS	OMS	.1	FALSE	FALSE		
<input type="checkbox"/>	SYS\$BACKGROUND	MMON_SLAVE	.1	FALSE	FALSE		
<input type="checkbox"/>	SYS\$USERS	emagent_SQL_oracle_database	.1	FALSE	FALSE		
<input type="checkbox"/>	SYS\$USERS	perl@dadvmc0233 (TNS V1-V3)	.1	FALSE	FALSE		
<input type="checkbox"/>	SYS\$USERS	perl@stbdf12 (TNS V1-V3)	.1	FALSE	FALSE		
<input type="checkbox"/>	SYS\$BACKGROUND	STREAMS	.1	FALSE	FALSE		

Enable Aggregation Disable Aggregation Enable SQL Trace Disable SQL Trace View SQL Trace File

**See Also:** "Top Consumers Page" in the Enterprise Manager online help

### Instance Activity

The Instance Activity link displays database activity for specific data about groups of metrics, such as cursors, sessions, and transactions ([Figure 6–11](#)). For instance, the Cursors metric group displays information about opened and session cursors along with authentications and parse counts. The legend links below the chart in the graphic view, or the name links in the table view, enable you to access the Top Sessions page for more detailed information.

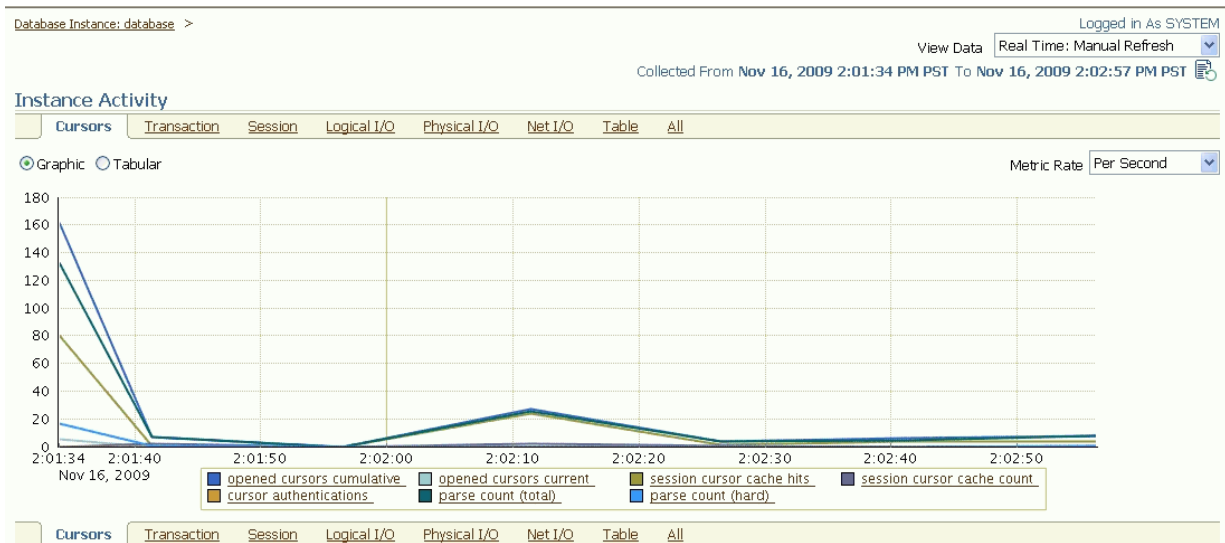
**Figure 6–11 Instance Activity Page**

**See Also:** "Instance Activity Page" in the Enterprise Manager online help

### Historical SQL

The Historical SQL (AWR) link displays statements stored in the Automatic Workload Repository (AWR) for a 24-hour period. This link is available in the Additional Monitoring Links section when you select the Historical data view (Figure 6–12).

The table at the bottom of the page shows an analysis of all SQL statements for performance and resource consumption. You can select a statement link to see SQL details (statistics, activity, SQL plan, and tuning information) for the statement. You can also run the SQL Tuning Advisor to receive recommendations for one or more statements.

**Figure 6–12 Historical SQL Page**

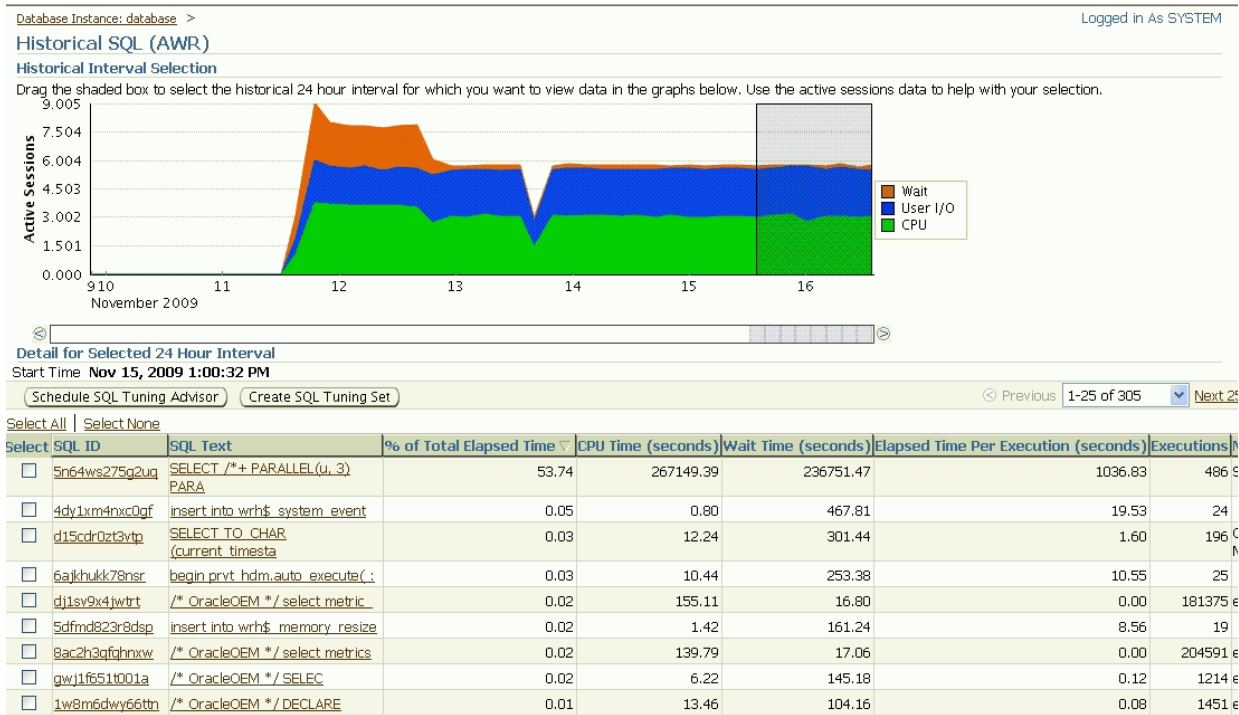

**See Also:** "Historical SQL (AWR) Page" in the Enterprise Manager online help

## Using Other Performance Tools

Enterprise Manager offers several tools that provide additional assistance ranging from viewing the relationships between system components to collecting system statistics when database performance is degraded. The following sections discuss these tools:

- Topology Viewer
- AWR Baselines
- Memory Access Mode
- Hang Analysis

### Topology Viewer

Enterprise Manager provides a Topology Viewer for several applications. The Topology Viewer allows you to view the relationships between components, nodes, or objects within different Oracle applications. You can zoom, pan, see selection details and summary information, and evaluate aggregate components. Individually distinct icons are used for each object type, and standardized visual indicators are used across all applications.

The Topology Viewer is available for the following database applications:

- Scheduler
- SQL Details
- SQL Explain Plans

- Oracle Real Application Clusters
- Cluster Databases

Figure 6–13 shows the Topology Viewer for the SQL Details Plan page. The Topology Viewer provides a graphical representation of your SQL steps as modeled in Enterprise Manager.

**Figure 6–13 Topology for SQL Details Plan**

Database Instance: database > Top Activity > SQL Details: 5n64ws275g2uq

Switch to SQL ID  Go View Data Real Time: Manual Refresh Refresh SQL Worksheet Schedule SQL Tuning Advisor SQL Repair Advisor

Text

```
SELECT /*+ PARALLEL(u, 3) PARALLEL(w, 3) */ COUNT (*)
FROM USERIO_OBJECTS W, USERIO_OBJECTS U
WHERE U.OBJECT_ID = W.OBJECT_ID
```

Details

Select the plan hash value to see the details below. Plan Hash Value 555618362

Statistics Activity Plan Plan Control Tuning History SQL Monitoring

Data Source Cursor Cache Capture Time Nov 16, 2009 2:16:14 PM GMT-08:00 Parsing Schema DBINST\_DEMO Optimizer Mode ALL\_ROWS

Additional Information

View Graph Table

Overview

Selection Details

Nothing Selected

TIP For an explanation of the icons and symbols used in this page, see the [Icon Key](#).

Show Explain Rewrite

## AWR Baselines

A baseline is a named period of time associated with a target and used as a reference for evaluating target performance (Figure 6–14). Baselines are an effective way to diagnose performance problems. AWR supports the capture of baseline data by enabling you to specify and preserve a pair of snapshots as a baseline.

**Figure 6–14 AWR Baselines Page**

Database Instance: database > Automatic Workload Repository > AWR Baselines

Page Refreshed Nov 16, 2009 2:21:05 PM

Search  Go

Edit View Delete Actions Schedule Statistics Computation Go

Select	Name	Type	Valid	Statistics Computed	Last Time Computed	Start Time	End Time
<input checked="" type="checkbox"/>	SYSTEM MOVING WINDOW	MOVING_WINDOW (8 Days)	Yes	Yes	Nov 14, 2009 4:00:01 PM	Nov 8, 2009 3:00:40 PM	Nov 16, 2009 1:40:48 PM

Related Links

[AWR Baseline Templates](#) [Baseline Metric Thresholds](#)

**See Also:** "AWR Baselines Page" in the Enterprise Manager online help

### Memory Access Mode

When the database server experiences performance issues, diagnostic queries could further impact the system. Memory Access Mode assists you in diagnosing performance-related problems by collecting system statistics even when the database is either slow or hung.

Instead of relying on the normal SQL engine, the data is retrieved by accessing tables directly from the Shared Global Area (SGA). The data collection is quick and does not further impact a system that is already slow. Potentially, this allows for sub-second sampling of performance metrics without causing any additional load on a system.

You can disable the standard SQL Access Mode and switch to Memory Access Mode by clicking the **Monitor in Memory Access Mode** link in the Related Links section.

**See Also:** "Database Performance Page" in the Enterprise Manager online help

### Hang Analysis

Hang Analysis enables you to diagnose locking issues that might either slow down a system or cause hanging. Normally, if a system is slow or in a hung state, the diagnostic queries are also either extremely slow or never return a result. This utility bypasses the typical query engine instead, and leverages the Oraclebug API to return results quickly even on systems that might be seemingly in a hung state.

The Hang Analysis page shows a visual map of the sessions that are either blocking or are blocked. A tree view of the sessions is displayed, and the problem session that is blocking other sessions is located at the root of the tree. Each session is shown color-coded, signifying how long the session has been blocked. Clicking on the session box brings up another page that shows session details. Using information from this page, you can cancel the problem session and return the system to its normal state.

You can access the Hang Analysis page by clicking the Hang Analysis link in the Additional Monitoring Links section.

**See Also:** "Hang Analysis Page" in the Enterprise Manager online help

## Administering Databases

Oracle Enterprise Manager effectively keeps your Oracle Databases available and running efficiently. Enterprise Manager can help database administrators perform everyday tasks. Specifically, it provides a graphical user interface for managing database storage structures and schemas. As with database monitoring, administration of the Oracle Database begins with the Oracle Database Home page. From this page, you can display an overview of your database properties and performance. However, you can also use the Administration section of the page to perform common administration tasks such as the following:

- Allocating system storage and planning future storage requirements for the database system
- Creating and managing primary database storage structures (tablespaces)
- Creating and managing primary objects (tables, views, indexes)
- Enrolling users and maintaining system security by controlling and monitoring user access to the database
- Backing up and restoring the database



Just as Enterprise Manager monitoring identifies problem areas in your database and database groups, you can administer your database using the Enterprise Manager administration tools. The administration tools allow you to manage database objects and initiate database operations inside an Oracle Database. The following sections provide an overview of the database administrative features available to you in Enterprise Manager.

## Managing Storage Objects

As an administrator, you can use the administration tools in Oracle Enterprise Manager to optimize database performance. Using these tools, you can manage storage structures such as control files, tablespaces, datafiles, and archive logs. In addition to viewing, editing, and deleting these structures, you can also perform other functions such as making tablespaces locally managed, displaying the dependencies of a datafile, or backing up a control file to a trace.

## Using Database Configuration Features

Oracle Enterprise Manager incorporates many features that help you to manage your database configuration. For example, you can use Enterprise Manager to manage the memory size of the system global area and program global area of your system. You can also use the Undo Management feature to provide a means of explicitly specifying the amount of undo information to retain and ensure that undo information is not overwritten.

You can create or edit initialization parameters for the current database, setting these parameters to specific values to initialize many of the memory and process settings of an Oracle Database instance. You can also display a list of database features, showing how often the features are used in the operation of the database. Usage information can be utilized by support groups and other organizations to gain knowledge about how the system is being used, and to help apportion resources as necessary.

## Using Automatic Storage Management

Databases can use Automatic Storage Management (ASM) for automation and layout simplification of datafiles, control files, and log files. You can use Enterprise Manager to migrate an existing database to ASM. If the database is already using ASM, you can use Enterprise Manager to create data files on disk groups.

Automatic Storage Management (ASM) simplifies database administration by managing disk groups instead of thousands of individual database files using disk groups. Database files are automatically distributed across all available disks, and database storage is rebalanced whenever the storage configuration changes. ASM internally creates, deletes and manages files as and when needed using the storage space from the disk groups. ASM also includes storage reliability features such as mirroring and parity protection commonly found in Logical Volume Managers. These features are available to an Oracle database or to Real Application Clusters (RAC).

An ASM instance is a special Oracle instance for coordinating ASM activities. An instance provides services to an Oracle database within a node. On a single node, there is typically a single ASM instance on the node which manages all disk groups. In a RAC environment, there is typically one ASM instance on each node which manages all disk groups for its node in a coordinated manner.

Automatic Storage Management files can be configured for use as general storage containers or volume devices. Oracle File System is a general-purpose file system that supports all customer application data files, both database and non-database including

those associated with an Oracle home. This support is on single host and cluster configurations.

**See Also:** "Administering Oracle ASM with Oracle Enterprise Manager" in the *Oracle Database Storage Administrator's Guide*.

## Converting Single Instances to Oracle Real Application Clusters

Oracle Real Application Clusters (RAC) provides a high-availability database environment spanning multiple hosts. Each cluster can be comprised of multiple cluster databases, each of which consists of multiple cluster database instances. A cluster database is available as long as one of its instances is available. You can use Enterprise Manager to asynchronously convert a single-instance database to an Oracle RAC database.

## Converting to a Locally-Managed Tablespace

An added feature allows you to convert a dictionary-managed tablespace to a locally-managed tablespace, thereby simplifying space allocation, improving performance, and reducing reliance on the data dictionary.

## Controlling Resources with Resource Manager

The Database Resource Manager controls the distribution of resources among various sessions by controlling the execution schedule inside the database. By controlling which sessions use more or less CPU, the Database Resource Manager can ensure that resource distribution matches the plan directive and hence, the business objectives. You can use the Database Resource Manager to automatically assign sessions to specific consumer groups by setting up mappings between session attributes and consumer groups. You can also map consumer groups in specified categories to users, client programs, modules, or services.

Resource consumer groups let you group user sessions together by resource requirements. Resource consumer groups are different from user roles; one database user can have different sessions assigned to different resource consumer groups. You can then use a resource plan to specify how the resources are to be distributed among various resource consumer groups.

Resource plans specify the resource consumer groups belonging to the plan and contain directives for how resources are to be allocated among these groups. Plan information is stored in tables in the data dictionary. Several views are available for viewing plan data. In addition to containing resource consumer groups, a plan can contain subplans. Use Enterprise Manager to manage all aspects of the resource plan.

## Tracking Statistics to Improve Database Performance

The Workload Repository provides you with a mechanism for gathering database statistics for specific time intervals. You can use the Optimizer Statistics feature of Enterprise Manager to simplify the management of Optimizer Statistics operations such as gathering, restoring, deleting, locking, and unlocking statistics. Use these statistics to improve the performance of your SQL statements.

## Using Oracle Scheduler

Oracle Scheduler enables database administrators and application developers to control when and where various tasks occur in the database environment. Using the Oracle Scheduler in Enterprise Manager helps to improve the management and

planning of these tasks. By separating a task into its component parts such as time, location, and database object, the Oracle Scheduler provides an easier way to manage your database environment. Database administrators can schedule and monitor recurring database maintenance jobs, such as backups or nightly data warehousing loads and extracts, and they can schedule job execution based on time or events.

With Enterprise Manager, you can enable and disable Scheduler jobs, alter the settings for existing jobs, start or stop current jobs, and view Scheduler information.

## Working With Database Schemas

A schema is a collection of database objects comprised of logical structures that directly refer to the data in the database. Schema objects include structures such as tables, views, and indexes. These schema objects can be created and managed using the tools available in Oracle Enterprise Manager.

## Managing Database Objects

Oracle Enterprise Manager provides a comprehensive set of tools that allows you to manage all aspects of database directory objects such as tables, indexes, and views. You can use the tools available in Enterprise Manager for fundamental tasks such as creating, editing, and viewing object properties, but you can also use Enterprise Manager for more comprehensive tasks such as running the Segment Advisor to evaluate a table for block and space usage and to determine whether space can be saved by shrinking highly fragmented segments. The space gained by the implementation of these recommendations is returned to the table.

Indexes are optional structures associated with tables that can be created to increase the performance of data retrieval. When you manage indexes in Enterprise Manager, you can perform functions such as shrinking segments to compact segments and free the recovered space to the current tablespace. Alternatively, you can also eliminate space problems by reorganizing space usage while changing the storage settings and location of the index.

Views are customized presentations of data in one or more tables or other views. In addition to creating, deleting, and managing views, you can also view the objects that are dependencies of the view. The Dependencies table shows you the Object Name and the Object Type that is dependent on the current view. Conversely, Enterprise Manager can also show you the objects on which the current view is dependent.

In general, use the Action menu on the Search page or Property page of any database object to see a list of the available functions you can perform on that object.

Enterprise Manager allows you to manage program structures, such as packages, package bodies, functions, and triggers in the same way. In addition to creating and viewing these elements, you can compile Java Sources, for example, or generate the data definition language (DDL) code for a specified object such as package. For more information about the various functions available for a specific object, you can refer to the online Help.

## XML Database Features in Oracle Enterprise Manager

XML (eXtensible Markup Language) is the standard way to identify and describe data on the Web. Oracle XML DB treats XML as a native datatype in the database. This helps to store, query, update, and transform XML data while accessing it using SQL.

Oracle XML DB offers a number of easy ways to create XML documents from relational tables. The result of any SQL query can be automatically converted into an

XML document. Oracle also includes a set of utilities, available in Java and C++, to simplify the task of creating XML documents.

Oracle Enterprise Manager helps to perform the following tasks related to Oracle XML DB:

- Configure Oracle XML DB — View or edit parameters for the Oracle XML DB configuration file, `/xdbconfig.xml`.
- Search, create, edit, and undelete Oracle XML DB Repository resources and their associated access control lists (ACLs).
- Search, create, edit, and delete XMLType tables and views.
- Search, create, register, and delete XML schemas.
- Create function-based indexes based on XPath expressions.

## Managing Users and Privileges

Oracle includes security features that control how a database is accessed and used. Privileges and roles control user access to data and the types of SQL statements that can be executed. There are two types of privileges: system privileges and object privileges. A system privilege is an Oracle-defined privilege that enables you to perform specific database operations, such as CREATE, ALTER, and so forth. An object privilege is an Oracle-defined privilege that controls access to a specific object.

Users, usually administrators, can create a role to group together privileges and other roles. This facilitates granting multiple privileges and roles to users.

Privileges and roles can be granted to other users by users who possess the authority to do so with the ADMIN/GRANT option. Oracle Enterprise Manager allows you to create and manage users, roles and profiles. You can also expire passwords and lock or unlock users by applying those actions against one or more users. When managing roles, you can display all users and roles assigned to the specified role by using the Show Grantees function.

Auditing is the monitoring and recording of selected user database actions. It can be based on individual actions, such as the type of SQL statement run, or on combinations of factors that can include name, application, time, and so on. Security policies can cause auditing when specified elements in an Oracle Database are accessed or altered, including content. You can set up and adjust audit settings easily within the Enterprise Manager interface. With Enterprise Manager, you can view the database audit configuration and manage audited objects, privileges, and statements. You can also view the content of the audit trail. Out-of-box, Enterprise Manager also provides audit reports to help you monitor successful and failed login attempts, as well as SYSUSER operations.

## Managing Materialized Views

Materialized views are schema objects that can be used to summarize, compute, replicate, and distribute data. They are suitable in various computing environments such as data warehousing, decision support, and distributed or mobile computing. Enterprise Manager lets you create and manage materialized views and provides a set of additional tools that allows you to perform specific actions against the view. The Explain Materialized View feature helps you to determine what is possible with a materialized view by indicating whether a materialized view is fast-refreshable, what types of query rewrites you can perform with this materialized view, and whether PCT refresh is possible.

Oracle maintains the data in materialized views by refreshing them after changes are made to their master tables. The refresh method can be incremental (fast refresh) or complete. For materialized views that use the fast refresh method, a materialized view log keeps a record of changes to the master tables. A complete refresh occurs when the materialized view is initially defined, unless it references a prebuilt table, and a complete refresh may be requested at any time during the life of the materialized view. Because the complete refresh involves reading the detail table to compute the results for the materialized view, this can be a very time-consuming process, especially if very large amounts of data need to be read and processed.

You can use Enterprise Manager to advise you when a query can be rewritten. You can then take the appropriate action required to make a query rewrite. Query rewrite transforms a SQL statement expressed in terms of tables or views into a statement accessing one or more materialized views that are defined on the detail tables.

Materialized views can be refreshed either on demand or at regular time intervals. You can use the Action menu in Enterprise Manager to manually refresh a materialized view.

## About Change Management

A dictionary baseline is an object containing a set of database definitions captured at a certain time. Baselines are stored internally in the Enterprise Manager repository, and are in a form that other Change Management applications can use. You can use Enterprise Manager to capture the database object definitions at a particular point in time and create reusable baseline scope specifications. By capturing a dictionary baseline, you can compare different database objects at different points in time and track changes applied to the database objects.

A dictionary comparison identifies differences in database object definitions between two databases, a database and a baseline, or two schemas within a single database/baseline. With Enterprise Manager, you can compare, view, and track differences between two sets of database object definitions at different points in time. The comparison result displays identical objects, objects/attributes that are different, and objects present either in the left or right source.

A dictionary synchronization synchronizes differences in database object definitions between two databases or a database and a baseline.

Synchronizations are generated using synchronization specifications. For synchronizations, the scope specification does not include the names of individual objects. It can only specify the types, and the schemas to be included or excluded. You can additionally supply a prefix to limit the objects selected to those whose names start with that prefix.

Dictionary synchronizations synchronize differences in any attribute value between objects of any type. Use synchronization specifications to create multiple versions of a synchronization. Each version has a unique version number and a synchronization date. Use these versions to associate synchronizations of database/schemas made over time.

For more information about these features, see [Change Management for Databases](#).

## Using Advisors in Oracle Enterprise Manager

Advisors are procedures that you can invoke, or Enterprise Manager can invoke internally, that designate a specific object for analysis. An advisor can report on a variety of database aspects, and describe a recommended action for each condition

worthy of user intervention. The advisor might report that the condition can be corrected by an automated task that it provides.

Some advisors also provide what-if analysis for specific situations. For example, the Undo Advisor provides an analysis of the impact of changing the retention period for undo records on the size of the undo tablespace. Additionally, the Memory Advisor graphically displays the impact on performance of changing the size of a component of the SGA.

You can invoke an advisor from the Advisor Central Home page that is displayed when you click the Advisor Central link under the Related Links heading on the Database Home page, or on other pages where it is listed. You can also invoke advisors in the context of recommendations from alerts. Advisors are powerful tools for tuning your database. In general, advisors produce more comprehensive recommendations than alerts, since alert generation is intended to be low cost and have minimal impact on performance. On the other hand, because Advisors are often user-invoked, they can consume more resources and perform more detailed analysis. Their automated analysis can provide more results than you might normally be able to produce manually in the time afforded you as part of regular operations. This analysis, along with the what-if capability of some advisors, provides vital information for tuning that cannot be procured from any other source.

## Managing Database Security

The following sections discuss various aspects of database security.

**Tip:** For other topics not discussed in the following sections, see Overview of Database Security in *Oracle Database Concepts*.

### Managing Users, Roles, Profiles, and Audit Settings

Oracle includes security features that control how a database is accessed and used. Privileges and roles control user access to data and the types of SQL statements that can be executed. There are two types of privileges: system privileges and object privileges. A system privilege is an Oracle-defined privilege that enables you to perform specific database operations, such as CREATE, ALTER, and so forth. An object privilege is an Oracle-defined privilege that controls access to a specific object.

Users, usually administrators, can create a role to group together privileges and other roles. This facilitates granting multiple privileges and roles to users.

Privileges and roles can be granted to other users by users who possess the authority to do so with the ADMIN/GRANT option. Oracle Enterprise Manager allows you to create and manage users, roles and profiles. You can also expire passwords and lock or unlock users by applying those actions against one or more users. When managing roles, you can display all users and roles assigned to the specified role by using the Show Grantees function.

Auditing is the monitoring and recording of selected user database actions. It can be based on individual actions, such as the type of SQL statement run, or on combinations of factors that can include name, application, time, and so on. Security policies can cause auditing when specified elements in an Oracle Database are accessed or altered, including content. You can set up and adjust audit settings easily within the Enterprise Manager interface. With Enterprise Manager, you can view the database audit configuration and manage audited objects, privileges, and statements. You can also view the content of the audit trail. Out-of-box, Enterprise Manager also provides audit reports to help you monitor successful and failed login attempts, as well as SYSUSER operations.

## Transparent Data Encryption

Oracle Advanced Security provides transparent data encryption to support your compliance efforts. Applications do not have to be modified, and existing applications continue to work seamlessly as before. Data is automatically encrypted when it is written to disk and automatically decrypted when the application accesses it. Key management is built-in, eliminating the complex task of creating, managing, and securing encryption keys.

Oracle Advanced Security transparent data encryption enables you to encrypt individual table columns or a tablespace. When a user inserts data into an encrypted column, the database automatically encrypts the data. When users select the column, the data is decrypted. This form of encryption is transparent, provides high performance, and is easy to implement.

Transparent data encryption includes industry-standard encryption algorithms such as the Advanced Encryption Standard (AES) as well as built-in key management.

The Enterprise Manager interface facilitates your usage of Transparent Data Encryption, enabling you to manage Wallet and Master Key.

## Oracle Label Security (OLS)

Oracle Label Security (OLS) is a security option that enables you to assign data classification and control access using security labels, addressing privacy and regulatory compliance requirements. OLS provides multi-level security, row-level access control out of the box, and provides elements to be used inside Oracle Database Vault.

OLS can do the following:

- Control access based on data classification, adding a powerful dimension to the access control decision process.
- Enforce traditional multi-level security (MLS) policies for government and defense applications.

The Enterprise Manager interface enables you to manage OLS Policies, assign policies to tables or schemas, and assign labels to users. You can assign a label to both data and users. When assigned to data, the label can be attached as a hidden column to existing tables, providing transparency to existing SQL. For example, rows that contain highly sensitive data can be labeled HIGHLY SENSITIVE, while rows that are less sensitive can be labeled SENSITIVE, and so on.

When a user attempts to access data, OLS compares the user label with the data label and determines whether access should be granted. Unlike VPD, OLS provides an out-of-the-box security policy and the metadata repository for defining and storing labels.

## Virtual Private Database (VPD)

Virtual Private Database (VPD) enables you to enforce security at the row and column level. A security policy establishes methods for protecting a database from accidental or malicious destruction of data or damage to the database infrastructure.

VPD is useful when security protections such as privileges and roles are not sufficiently fine-grained. For example, you can allow all users to access the employees table, but create security policies to restrict access to employees in the same department as the user. The Enterprise Manager interface enables you to manage VPD policies and various operations associated with it.

Essentially, the database adds a dynamic WHERE clause to a SQL statement issued against the table, view, or synonym to which an Oracle VPD security policy was applied. The WHERE clause allows only users whose credentials pass the security policy to access the protected data.

## Application Contexts

Application contexts enable you to write applications that draw upon certain aspects of a user's session information. It provides a method of defining, setting, and accessing attributes that an application can use.

An Application context is a namespace. Each Application Context namespace can have multiple attributes (name/value pairs). These are associated with a user session and can be set/accessed multiple times.

You can store Globally Initialized Application Context attributes in Oracle Internet Directory and assign them to one or more enterprise users. An enterprise user can retrieve the attributes automatically upon login and then use them to initialize an application context.

## Enterprise User Security

Enterprise User Security, an Oracle Database Enterprise Edition feature, combined with Oracle Identity Management, enables you to centrally manage database users and authorizations in one location. This dramatically reduces the cost of user provisioning and password resets. This feature should be considered for new application development and existing applications as well.

Enterprise User Security increases security in various ways, such as:

- Centralizing provisioning and deprovisioning of database users.
- Centralizing password management and self-service password reset capability.
- Centralizing management of authorizations using global database roles.

## Oracle Database Vault

The Payment Card Industry (PCI), Sarbanes-Oxley (SOX), EU Privacy Directive, and the Healthcare Insurance Portability and Accountability Act (HIPAA) all require strong internal controls on access, disclosure or modification of sensitive information that could lead to fraud, identity theft, financial irregularities and financial penalties.

Oracle Database Vault addresses common regulatory compliance requirements and reduces the risk of insider threats by:

- Preventing highly privileged users (DBA) from accessing application data.
- Enforcing separation of duty.
- Providing controls over who, when, where, and how applications, data, and databases can be accessed.

When you enable a Database Vault in your database, Enterprise Manager provides an interface you can use to monitor Database Vault policies, and also propagate policies to multiple databases.



## Masking Sensitive Data for Non-production Use

Data masking (also known as data scrambling and data anonymization,) is the process of replacing sensitive information copied from production databases to test or non-production databases with realistic, but scrubbed, data based on masking rules. Data masking is ideal for virtually any situation when confidential or regulated data needs to be shared with other non-production users; for instance, internal users such as application developers, or external business partners, like offshore testing companies or suppliers and customers. These non-production users need to access some of the original data, but do not need to see every column of every table, especially when the information is protected by government regulations.

Data masking allows organizations to generate realistic and fully functional data with similar characteristics as the original data to replace sensitive or confidential information. This contrasts with encryption or Virtual Private Database, which simply hides data, and the original data can be retrieved with the appropriate access or key. With data masking, the original sensitive data cannot be retrieved or accessed.

Names, addresses, phone numbers, and credit card details are examples of data that require protection of the information content from inappropriate visibility. Live production database environments contain valuable and confidential data — access to this information is tightly controlled. However, each production system usually has replicated development copies, and the controls on such test environments are less stringent. This greatly increases the risks that the data might be used inappropriately. Data masking can modify sensitive database records so that they remain usable, but contain no confidential or personally identifiable information. Yet, the masked test data resembles the original in appearance to ensure the integrity of the application.

## Security and Regulatory Compliance

Masked data is a sensible precaution from a business security standpoint, because masked test information can help prevent accidental data escapes. In many cases, masked data is a legal obligation. The Enterprise Manager Data Masking Pack can help organizations fulfill legal obligations and comply with global regulatory requirements, such as Sarbanes-Oxley, the California Database Security Breach Notification Act (CA Senate Bill 1386), and the European Union Data Protection Directive.

The legal requirements vary from country to country, but most countries now have regulations of some form to protect the confidentiality and integrity of personal consumer information. For example, in the United States, The Right to Financial Privacy Act of 1978 creates statutory Fourth Amendment protection for financial records, and a host of individual state laws require this. Similarly, the U.S. Health Insurance Portability and Accountability Act (HIPAA) created protection of personal medical information.

## Roles of Data Masking Users

The following types of users participate in the data masking process for a typical enterprise:

- Application database administrator or application developer  
This user is knowledgeable about the application and database objects. This user may add additional custom database objects or extensions to packaged applications, such as the Oracle E-Business suite.
- Information security administrator

This user defines information security policies, enforces security best practices, and also recommends the data to be hidden and protected.

## Format Libraries and Masking Definitions

To mask data, the Data Masking Pack provides two main features:

- **Masking format libraries**

The format library contains a collection of ready-to-use masking formats. The library consists of format routines that you can use for masking. A masking format can either be one that you create, or one from the list of Oracle-supplied default masking formats.

As a matter of best practice, organizations should create masking formats for all common regulated information so that they can be applied to the sensitive data regardless of which database the sensitive data resides in. This ensures that all sensitive data is consistently masked across the entire organization.

- **Masking definitions**

A masking definition defines a data masking operation to be implemented on one or more tables in a database. Masking definitions associate table columns with formats to use for masking the data. They also maintain the relationship between columns that are not formally declared in the database using related columns.

You can create a new masking definition or use an existing definition for a masking operation. To create a masking definition, you specify the column of the table for which the data should be masked and the format of masked data. If the columns being masked are involved in unique, primary key, or foreign key constraints, data masking generates the values so that the constraints are not violated. Masking ensures uniqueness per character using decimal arithmetic. For example, a 5-character string generates a maximum of only 99999 unique values. Similarly, a 1-character string generates a maximum of only 9 unique values.

You would typically export masking definitions to files and import them on other systems. This is important when the test and production sites reside on different Oracle Management Systems or reside on entirely different sites.

Data masking is an iterative and evolving process handled by the security administrator and orchestrated by the database administrator. When you first configure data masking, try out the masking definition on a test system, then add a greater number of columns to the masking definition and test it to make sure it functions correctly and does not break any application constraints. During this process, you should exercise care when removing all imbedded references to the real data while maintaining referential integrity. After data masking is configured to your satisfaction, you can use the existing definition to repeatedly mask after cloning. The masking definition, however, would need to evolve as new schema changes require new data and columns to be masked.

**See Also:** "Creating a Data Masking Definition" in the Enterprise Manager online help as well as the help for each Data Masking page.

## Recommended Data Masking Workflow

Figure 6–15 shows that the production database is cloned to a staging region and then masked there. During the masking process, the staging and test areas are tightly controlled like a production site.

After the masking process is complete, you can distribute the database for wide availability. If you need to ship the database to another third-party site, you are required to use the Data Pump Export utility, and then ship the dump file to the remote site. However, if you are retaining the masked data in-house, see the next section.

**Figure 6–15 Data Masking Workflow**

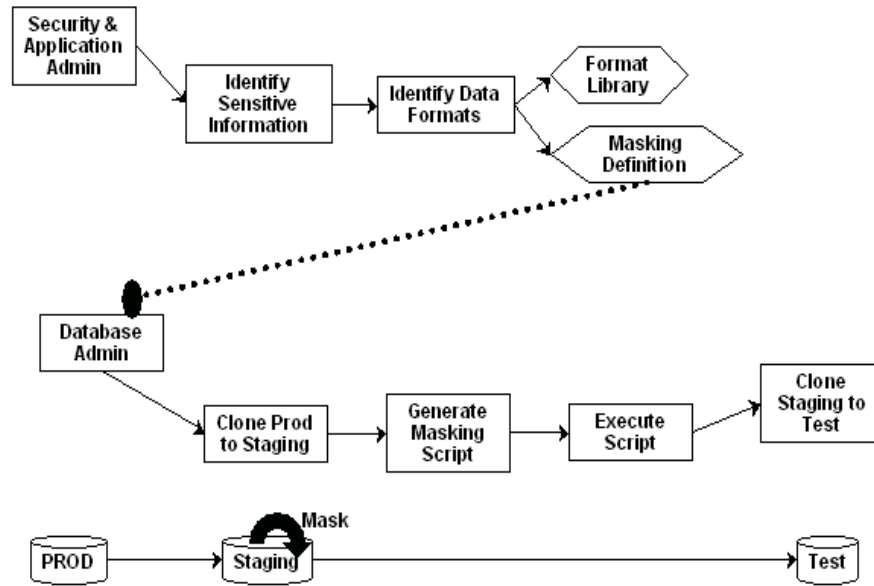

## Data Masking Task Sequence

The task sequence in this section demonstrates the data masking workflow and refers you to additional information elsewhere in this chapter for some of the tasks in the sequence. Before reviewing this sequence, note that there are two options for completing this process:

- You can clone the production database to a staging area, mask it, then export/import it to another database before delivering it to in-house testers or external customers. This is the most secure approach.
- You can clone the production database to a mask staging area, then make the staging area the new test region. In this case, you should not grant testers SYSDBA access or access to the database files. Doing so would compromise security. The masked database contains the original data in unused blocks and in the free list. You can only purge this information by exporting/importing the data to another database.

The following steps guide you through the data masking process. Note the references to other sections for supporting information.

1. Review the application database and identify the sources of sensitive information.
2. Define mask formats for the sensitive data. The mask formats may be simple or complex depending on the information security needs of the organization.

See "[Data Masking Task Sequence](#)" on page 6-29 for more information.

3. Create a masking definition to associate table columns to these mask formats. Data masking determines the database foreign key relationships and adds foreign key columns to the mask.

See ["Creating a Masking Definition"](#) on page 6-33 for more information.

4. Optionally declare dependent columns not defined in the database but enforced by the applications. Masking assumes it should perform the masking to honor these additional constraints.

This requires knowledge of the application schema. Consult the application documentation to identify the relationship between the tables and the columns containing sensitive data to ensure complete coverage of your application data.

See ["Adding Dependent Columns"](#) on page 6-36 for more information.

5. Save the masking definition and generate the masking script.
6. Clone the production database to a staging area, selecting the masking definition to be used after cloning. Note that you can perform cloning using Enterprise Manager, which enables you to add masking to the Enterprise Manager clone workflow. However, if you performing cloning outside of Enterprise Manager, you must initiate masking from Enterprise Manager after cloning is complete. The cloned database should be controlled with the same privileges as the production system since it still contains sensitive production data.

After cloning, be sure to change the passwords as well as update or disable any database links, streams, or references to external data sources. Back up the cloned database or, at a minimum, the tables that contain masked data. This will help you restore the original data if the masking definition needs to be refined further.

See ["Cloning the Production Database"](#) on page 6-37 for more information.

7. Verify if the masked data meets the information security requirements. Otherwise, refine the masking definition, restore the altered tables, and reapply the masking definition until the optimal set of masking definitions has been identified.
8. After masking, test all of your applications, reports, and business processes to ensure they are functional. If everything is working, you can export the masking definition to keep it as a backup.
9. After masking the staging site, make sure to drop any tables named MGMT\_DM\_TT before cloning to a test region. These temporary tables contain a mapping between the original sensitive column value and the mask values and are therefore sensitive in nature.

During masking, Enterprise Manager automatically drops these temporary tables for you with the default "Drop temporary tables created during masking" option. However, you can preserve these temporary tables by unselecting this option. In this case, you are responsible for deleting the temporary tables before cloning to the test region.

10. After masking is complete, ensure that all tables loaded for use by the substitute column format or table column format will be dropped. These tables contain the mask values that table column or substitute formats will use. It is recommended that you purge this information for security reasons.

See ["Deterministic Masking"](#) on page 6-39 for more information.

11. Clone the database to a test region or use it as the new test region. When cloning the database to an external or unsecured site, you should use Export or Import, and only supply the data in the database rather than the database files themselves.

12. Provide the masking definition to the application database administrator to use in masking the database as part of cloning production for testing.

## Defining New Masking Formats

A masking definition requires one or more masking formats for any columns included in the masking definition. When adding columns to a masking definition, you can either create masking formats manually or import them from the format library. It is often more efficient to work with masking formats from the format library.

To create a masking format in the format library, do the following:

1. Navigate to the **Databases** targets roll-up page. The Databases page appears.
2. Click the **Data Masking Format Library** link. The Format Library appears with predefined formats that Oracle Enterprise Manager provides.
3. Click **Create**. The Create Format page appears, where you can define a masking format.

**Tip:** For information on page user controls, see the online help for the Format page.

4. Provide a required name for the new format, select a format entry type from the **Add** drop-down list, then click **Go**.

A page appears that enables you to provide input for the format entry you have selected. For instance, if you select Array List, the subsequent page enables you to enter a list of values, such as New York, New Jersey, and New Hampshire.

5. Continue adding additional format entries as needed.
6. When done, provide an optional user-defined or post-processing function (see ["Providing User-defined and Post-processing Functions"](#)), then click **OK** to save the masking format.

The Format Library page reappears with your newly created format displayed in the Format Library table.

**Tip:** For information on page user controls, see the online help for the Format Library and Create Format pages.

### Providing User-defined and Post-processing Functions

If desired, you can provide user-defined and post-processing functions on the Create Format page. A user-defined choice is available in the Add drop-down, and post-processing function field is available at the bottom of the page.

#### ■ User-defined functions

To provide a user-defined function, select **User Defined Function** from the Add drop-down, then click **Go** to access the input fields.

A user-defined function passes in the original value as input and returns a mask value. The data type and uniqueness of the output values must be compatible with the original output values. Otherwise, a failure occurs when the job runs. Combinable, a user-defined function is a PL/SQL function that can be invoked in a Select statement. Its signature is returned as:

```
Function udf_func (rowid varchar2, column_name varchar2, original_value
varchar2) returns varchar2;
```

- rowid is the min (rowid) of the rows that contain the value original\_value 3rd argument.
- column\_name is the name of the column being masked.
- original\_value is the value being masked.

That is, it accepts an input string that is the original value and returns the mask value.

Both input and output values are varchar2. For instance, a user-defined function to mask a number could receive 100 as input, the string representation of the number 100, and return 99, the string representation of the number 99. Values are cast appropriately when inserting to the table. If the value is not castable, masking fails.

#### ■ **Post-processing functions**

To provide a post-processing function, enter it in the **Post Processing Function** field.

A post-processing function has the same signature as a user-defined function, but passes in the mask value the masking engine generates, and returns the mask value that should be used for masking, as shown in the following example:

```
Function post_proc_udf_func (rowid varchar2, column_name varchar2, mask_value  
varchar2) returns varchar2;
```

- rowid is the min (rowid) of the rows that contain the value mask\_value.
- column\_name is the name of the column being masked.
- mask\_value is the value being masked.

#### **Using Masking Format Templates**

After you have created at least one format, you can use the format definition as a template in the Create Format page, where you can implement most of the format under a different name and change the entries as needed, rather than having to create a new format from scratch.

To create a new format that is similar to an existing format, select a format on the Format Library page and click **Create Like**. The masking format you select can either be one you have previously defined yourself, or one from the list of out-of-box masking formats. You can use these generic masking format definitions for different applications.

See "[Using Oracle-supplied Predefined Masking Formats](#)" for instructional details about the various Oracle-supplied predefined masking format definitions and how to modify them to suit your needs.

## **Using Oracle-supplied Predefined Masking Formats**

The following sections discuss the various Oracle-supplied format definitions and how to modify them to suit your needs.

### **Patterns of Format Definitions**

All of the format definitions adhere to these typical patterns:

- Generate a random number or random digits.
- Perform post-processing on the above-generated value to ensure that the final result is a valid, realistic value

For example, a valid credit card number must pass Luhn's check. That is, the last digit of any credit card number is a checksum digit, which is always computed. Also, the first few digits indicate the card type (MasterCard, Amex, Visa, and so forth). Consequently, the format definition of a credit card would be as follows:

- Generate random and unique 10-digit numbers.
- Using a post-processing function, transform the values above to a proper credit card number by adding well known card type prefixes and computing the last digit.

This format is capable of generating 10 billion unique credit card numbers.

## Category Definitions

The following sections discuss different categories of these definitions. By default, these mask formats are also available in different format styles, such as a hyphen ( - ) format. If needed, you can modify the format style.

### Credit Card Numbers

Out of the box, the format library provides many different formats for credit cards. The credit card numbers generated by these format pass the standard credit card validation tests by the applications, thereby making them appear like valid credit card numbers.

Some of the credit card formats you can use are:

- MasterCard numbers
- Visa card numbers
- American Express card numbers
- Discover Card numbers
- Any credit card number  
(Credit card numbers belong to all types of cards.)

You may want to use different styles for storing credit card numbers, such as:

- Pure numbers
- 'Space' for every four digits
- 'Hyphen' ( - ) for every four digits, and so forth

To implement the masked values in a certain format style, you can set the `DM_CC_FORMAT` variable of the `DM_FMTLIB` package. To install the `DM_FMTLIB` package, see "[Installing the DM\\_FMTLIB Package](#)" on page 6-32.

### United States Social Security Numbers

Out of the box, you can generate valid U.S. social security (SSN) numbers. These SSNs pass the normal application tests of a valid SSN.

You can affect the format style by setting the `DM_SSN_FORMAT` variable of the `DM_FMTLIB` package. For example, if you set this variable to '-', the typical social security number would appear as '123-45-6789'.

### ISBN Numbers

Using the format library, you can generate either 10-digit or 13-digit ISBN numbers. These numbers adhere to standard ISBN number validation tests. All of these ISBN numbers are random in nature. Similar to other format definitions, you can affect the "style" of the ISBN format by setting values to `DM_ISBN_FORMAT`.

### UPC Numbers

Using the format library, you can generate valid UPC numbers. They adhere to standard tests for valid UPC numbers. You can affect the formatting style by setting the `DM_UPC_FORMAT` value of the `DM_FMTLIB` package.

### Canadian Social Insurance Numbers

Using the format library, you can generate valid Canadian Social Insurance Numbers (SINs). These numbers adhere to standard tests of Canadian SINs. You can affect the formatting style by setting the `DM_CN_SIN_FORMAT` value of the `DM_FMTLIB` package.

### North American Phone Numbers

Out of the box, the format library provides various possible U.S. and Canadian phone numbers. These are valid, realistic looking numbers than can pass standard phone number validation tests employed by applications. You can generate the following types of numbers:

- Any North American phone numbers
- Any Canadian phone number
- Any U.S.A. phone number

### Installing the `DM_FMTLIB` Package

The predefined masking formats use functions defined in the `DM_FMTLIB` package. This package is automatically installed in the `DBSNMP` schema of your Enterprise Manager repository database. To use the predefined masking formats on a target database (other than the repository database), you must manually install the `DM_FMTLIB` package on that database. To do this, follow these instructions:

1. Locate the following scripts in your Enterprise Manager installation:

```
$ORACLE_HOME/sysman/admin/emdrep/sql/db/latest/masking/dm_fmllib_pkgdef.sql  
$ORACLE_HOME/sysman/admin/emdrep/sql/db/latest/masking/dm_fmllib_pkgbody.plb
```

2. Copy these scripts to a directory in your target database installation and execute them using `SQL*Plus`, connected as a user that can create packages in the `DBSNMP` schema.

After you have done this, you can use the predefined masking formats in your masking definition.

## Agent Compatibility for Data Masking

Data Masking supports Oracle Database 9i and later. Enterprise Manager 11.1 Grid Control requires the 11.1 Agent. If you have a version prior to 11.1, you can use it by implementing the following work-around.

Replace the following file...

```
AGENT_HOME/sysman/admin/scripts/db/reorg/reorganize.pl
```

... with this file:

```
OMS_HOME/sysman/admin/scripts/db/reorg/reorganize.pl
```

## Supported Data Types

The list of supported data types varies by release.



- **Grid Control 10g Release 5 (10.2.0.5) and Database 11g Release 2 (11.2)**

- **Numeric Types**

The following Numeric Types can use Array List, Delete, Fixed Number, Null Value, Post Processing Function, Preserve Original Data, Random Decimal Numbers, Random Numbers, Shuffle, SQL Expression, Substitute, Table Column, Truncate, and User Defined Function formats:

- \* NUMBER
- \* FLOAT
- \* RAW
- \* BINARY\_FLOAT
- \* BINARY\_DOUBLE

- **String Types**

The following String Types can use Array List, Delete, Fixed Number, Fixed String, Null Value, Post Processing Function, Preserve Original Data, Random Decimal Numbers, Random Digits, Random Numbers, Random Strings, Shuffle, SQL Expression, Substitute, Substring, Table Column, Truncate, and User Defined Function formats:

- \* CHAR
- \* NCHAR
- \* VARCHAR2
- \* NVARCHAR2

- **Date Types**

The following Date Types can use Array List, Delete, Null Value, Post Processing Function, Preserve Original Data, Random Dates, Shuffle, SQL Expression, Substitute, Table Column, Truncate, and User Defined Function formats:

- \* DATE
- \* TIMESTAMP

- **Grid Control 11g Release 1 (11.1.0.1)**

Besides the support described above for Grid Control 10.2 and Database 11.2, Grid Control 11.1 also supports the following Lob Types that can use Fixed String, Fixed Number, and Null:

- CLOB
- NCLOB
- BLOB

## Creating a Masking Definition

Before creating a masking definition, be aware of the following advisory information:

- Make sure the format you select does not violate check constraints and does not break any applications that use the data.
- For triggers and PL/SQL packages, data masking recompiles the object.

- Exercise caution when masking partitioned tables, especially if you are masking the partition key. In this circumstance, the row may move to another partition.
- Data Masking does not support clustered tables, masking information in object tables, XML tables, and virtual columns. Relational tables are supported for the masking.
- If objects are layered on top of a table such as views, materialized views, and PL/SQL packages, they are recompiled to be valid.

To create a masking definition, do the following:

1. Navigate to the **Databases** targets roll-up page. The Databases page appears.
2. Click the **Data Masking Definitions** link under the Related Links section. The Data Masking Definitions page appears, where you can create and schedule new masking definitions and manage existing masking definitions.

**Tip:** For information on page user controls, see the online help for the Data Masking Definitions page.

3. Click **Create** to go to the Create Masking Definition page. A masking definition includes information regarding table columns and the format for each column. You can choose which columns to mask, leaving the remaining columns intact.

**Tip:** For information on page user controls, see the online help for the Create Masking Definition page.

4. Specify a required database name. The Database field shows the database name of the database target you selected before accessing the Data Masking Definitions Page. You can specify any of the available databases. To search for the list, click the flashlight icon.
5. Click **Add** to go to the Add Columns page, where you can add one or more columns for masking and automatically add foreign key columns. You need to add at least one column in the masking definition.

**Tip:** For information on page user controls, see the online help for the Add Columns page.

6. In the Search section, minimally provide a schema name and optionally provide input for the other search fields to filter the results, then click **Search**.
7. Either select one or more columns for formatting later on the Create Masking Definition page, or formatting now if the data types of the columns you have selected are identical.

**Tip:** For information on data types, see "[Supported Data Types](#)".

8. Decide if you want to mask selected columns as a group.

Select this checkbox if you want to mask more than one column together, rather than separately. When you then select two or more columns and then later define the format on the Define Group Mask page, the columns appear together, and any choices you make for format type or masking table apply collectively to all of the columns.

Columns that you want to mask as a group must all be from the same table.

9. Either click **Add** to add the column to the masking definition, return to the Create Masking Definition page, and define the format of the column later, or click **Define Format and Add** to define the format for the column now.

The Define Format and Add feature can save you significant time. When you select multiple columns to add that have the same data type, you do not need to define the format for each column as you would when you click Add. For instance, if you search for social security numbers (SSN) and this yields 100 SSN columns, you could select them all, then click Define Format and Add to import the SSN format for all of them.

**10. If you clicked Add in the previous step...**

... you will eventually need to define the format of the column in the Create Masking Definition page before you can proceed. When you are ready to do so, click the icon in the page **Format** column for the column you want to format. Depending on whether you decided to mask selected columns as a group on the Add Columns page, either the Define Column mask or Define Group mask appears. Read further in this step for instructions for both cases.

**If you clicked Define Format and Add in the previous step and did not check "Mask selected columns as a group," ...**

... the Define Column Mask page appears, where you can define the format for the column before adding the column to the Create Masking Definition page.

- a. Provide a format entry for the required Default condition by either selecting a format entry from the drop down list and clicking **Add**, or clicking **Import Format**, selecting a predefined format on the Import Format page, then clicking **Import**.

See "[Using Oracle-supplied Predefined Masking Formats](#)" for information about Oracle-supplied predefined masking format definitions.

**Tip:** For information on page user controls, see the online help for the Define Column Mask page.

- b. Add another condition by clicking **Add Condition** to add a new condition row, then provide one or more format entries as described in the previous step. [Figure 6-16](#) shows an example of user input.

Figure 6–16 Sample Input for Define Column Mask Page

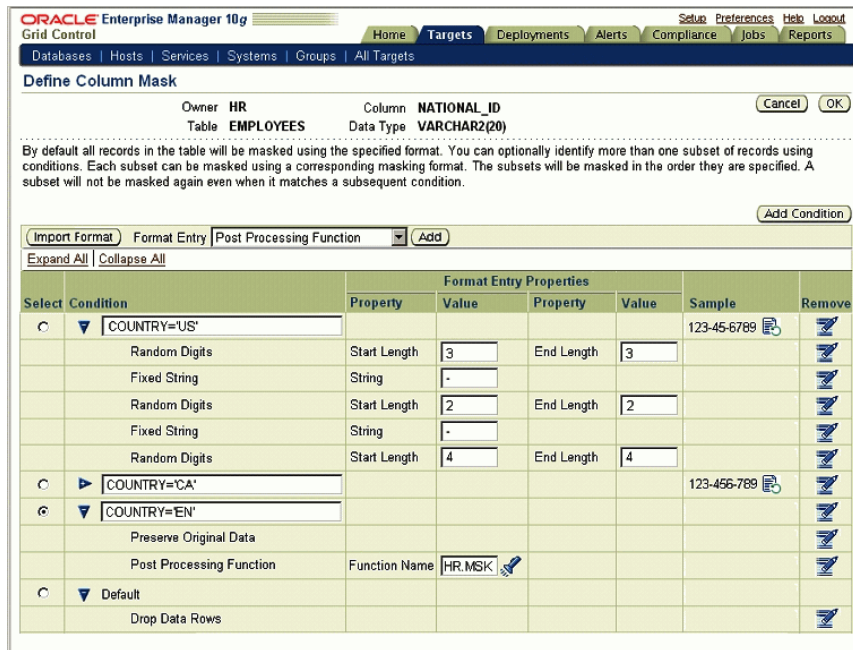

- c. When you have finished formatting the column, click **OK** to return to the Create Masking Definition page.

**If you clicked Define Format and Add in the previous step and checked "Mask selected columns as a group," ....**

... the Define Group Mask page appears, where you can add format entries for group columns that appear in the Create Masking Definition page.

- a. Select one of the available format types. For complete information on the format types, see the online help.

**Tip:** For information on page user controls, see the online help for the Define Group Mask page.

- b. Optionally add a column to the group.
  - c. When you have finished formatting the group, click **OK** to return to the Create Masking Definition page. Your configuration appears in the Columns table.
11. Click **OK** to save your definition and return to the Data Masking Definitions page.

At this point, super administrators can see each other’s masking definitions.

12. Select the definition and click **Generate Script** to view the script for the list of database commands used to mask the columns you selected earlier.

From the Script Generation Results page that appears, you can clone and mask the database or schedule the data masking job.

**Tip:** For information on page user controls, see the online help for the Script Generation Results page.

---

---

**Note:** If any tables included in the masking definition or reorganization have columns of data type LONG, a warning message may appear. See [Using Data Masking with LONG Columns](#) on page 6-39 for more information.

---

---

13. Make one of the following choices:

- If you are working with a production database, click **Clone and Mask**.
- If you are already working with a test database and want to directly mask the data in this database, click **Schedule Job**.

## Adding Dependent Columns

The following prerequisites apply for the column to be defined as dependent:

- A valid dependent column should not already be included for masking.
- The column should not be a foreign key column or referenced by a foreign key column.
- The column data should conform to that in the parent column.

If the column does not meet these criteria, an "Invalid Dependent Columns" message appears when you attempt to add the dependent column.

To add dependent columns, do the following:

1. From the Create Masking Definition page, click the **Add +** icon in the Dependent Columns Add column for the column you want to format. The Add Dependent Columns page appears.

**Tip:** For information on page user controls, see the online help for the Add Dependent Columns page.

2. In the Search section, minimally provide a schema name or select it by first clicking on the flashlight search icon, then clicking **Search**.
3. Select one or more column names from the list that appears below, then click **Add**.  
The Create Masking Definition page reappears and displays your added dependent column(s) in the Dependent Columns table at the bottom of the page. The dependent column(s) will be masked using the same format as that specified for the parent column.

## Cloning the Production Database

To clone and optionally mask the masking definition's target database, do the following:

1. Ensure that you have a Provisioning and Patch Automation pack license before proceeding. The Clone Database feature requires this license.
2. From the Data Masking Definitions page, select the masking definition you want to clone, select **Clone Database** from the Actions drop-down, then click **Go**. The Clone Database wizard appears, where you can create a test system to run the mask.
3. Proceed through the wizard steps as you ordinarily would to clone a database. For assistance, refer to the online help for each step.

4. In the Database Configuration step of the wizard, add a masking definition.
5. Schedule and then run the clone job.

## Using Reorganize Objects with LONG Columns

When Reorganize Objects script generation completes, an impact report appears. If any tables included in the reorganization have columns of data type LONG, the following warning message may be displayed in the impact report:

Reorganization includes a table with a LONG column. To support reorganization of tables with LONG columns that are greater than 32KB, the external procedure MGMT\$REORG\_MOVELONGCOMMAND must be configured properly. It has been determined this external procedure is not currently configured as expected.

If this message is displayed in the impact report, examine the data in the LONG columns. If the data is less than 32KB, you can ignore this message. If the data is greater than 32KB, return from the Reorganize Objects wizard and use the following procedure to configure the database for external procedure connections.

1. Shut down the target database and its listener.
2. Edit `$ORACLE_HOME/network/admin/tnsnames.ora` and add the following entry:

```
EXTPROC_CONNECTION_DATA =
  (DESCRIPTION =
    (ADDRESS_LIST =
      (PROTOCOL=IPC) (KEY=EXTPROC))
    (CONNECT_DATA =
      (SID=PLSExtProc) (PRESENTATION=RO)))
```

3. Save the changes to `tnsnames.ora` and exit the editor.
4. Edit `$ORACLE_HOME/network/admin/listener.ora` and make the following changes:
  - a. An entry in `listener.ora` looks similar to the following example:

```
LISTENER =
  (DESCRIPTION_LIST =
    (DESCRIPTION =
      (ADDRESS_LIST =
        (ADDRESS =
          (PROTOCOL = tcp) (HOST = host1.us.oracle.com) (PORT = 1521))))))
```

Add a new ADDRESS\_LIST parameter to this entry:

```
LISTENER =
  (DESCRIPTION_LIST =
    (DESCRIPTION =
      (ADDRESS_LIST =
        (ADDRESS =
          (PROTOCOL = tcp) (HOST = host1.us.oracle.com)
          (PORT = 1521)))
      (ADDRESS_LIST =
        (ADDRESS = (PROTOCOL = IPC) (KEY = EXTPROC))))))
```

- b. A second entry in `listener.ora` looks similar to the following example:

```
SID_LIST_LISTENER =
  (SID_LIST =
    (SID_DESC = (SID_NAME = db1) (ORACLE_HOME = /scratch/oracle/db1)))
```

Add a new `SID_DESC` parameter to this entry:

```
SID_LIST_LISTENER =
(SID_LIST =
(SID_DESC = (SID_NAME = db1)(ORACLE_HOME = /scratch/oracle/db1))
(SID_DESC =
(SID_NAME = PLSExtProc)
(ORACLE_HOME = /scratch/oracle/db1)
(PROGRAM = extproc)
(ENVS =
"EXTPROC_DLLS=ANY,
LD_LIBRARY_PATH=/usr/lib:/scratch/oracle/db1/lib"))))
```

5. Save the changes to `listener.ora` and exit the editor.
6. Ensure that the following file exists in your database installation:  
`$ORACLE_HOME/lib/libnmuc.so`
7. Restart the listener and the database.
8. Launch Reorganize Objects and generate the script. The warning message should now not appear in the impact report.
9. Schedule and submit the job. The following message will appear in the job output log:

```
Copy with PLSQL block failed due to size of long. Using Mgmt$Reorg_
MoveLongCommand to perform the reorganization.
```

This message is expected. Any tables with LONG columns are masked or reorganized successfully.

## Using Data Masking with LONG Columns

Data Masking supports tables with long columns differently than tables without long columns. Tables with long columns are updated using an Update SQL statement, and only columns that need to be masked are changed. The long column itself is left intact. Tables without long columns are masked by dropping, recreating, and reloading the table data with masked values. This process performs faster than updates and is used, therefore, except for long columns that SQL does not support.

When long column tables are masked, the Update statements produce undo information that can be used to retrieve the old values using flashback query. To avoid this, you must export import the data to another database, purge undo information, or disable flashback query.

## Deterministic Masking

You may occasionally need to consistently mask multiple, distinct databases. For instance, if you run HR, payroll, and benefits that have an employee ID concept on three separate databases, the concept may be consistent for all of these databases, in that an employee's ID can be selected to retrieve the employee's HR, payroll, or benefits information. Based on this premise, if you were to mask the employee's ID because it actually contains his/her social security number, you would have to mask this consistently across these three databases.

Deterministic masking provides a solution for this problem. You can use the Substitute format to mask employee ID column(s) in all three databases. The Substitute format uses a table of values from which to substitute the original value with a mask value.

As long as this table of values does not change, the mask is deterministic or consistent across the three databases.

**Tip:** For more information on the Substitute format, see the online help for the Define Column Mask page.

## Use Cases

The following use cases show some of the more important data masking tasks that you can perform.

### **Mask production data for an application maintained in a staging environment**

This use case applies to the application database administrator except for step 6.

1. Log into the system as the application database administrator to access databases and their associated privileges.
2. Search the schema for tables that contain columns with confidential or regulated information. The system responds by displaying tables and columns based on search criteria.
3. Select the table columns as well as the appropriate mask formats. The system responds by adding the table column and all of its associated foreign key columns into the masking definition.
4. Assign additional table columns to the masking definition wherein explicit referential integrity relationships are not defined in the database. The system responds by adding these table columns as dependent columns to the masking definition.
5. Notify the information security administrator of the masking definition.
6. The information security administrator reviews the masking definition, verifies its completeness, then recommends that the application database administrator proceed with the masking process.
7. Initiate the data masking process using the masking definition created in step 4. The system responds by validating the masking definition, verifying space availability, then applying the mask formats to the data in the test-staging database.
8. Verify the completeness of the masking process, and confirm that masked data has replaced sensitive data.

### **Use an existing masking definition to mask a new database**

This use case applies to the application database administrator.

1. Create a new masking definition based on a previously created masking definition that is then applied to a new database. The system responds by copying the masking definition, including table columns and mask formats, and associating it with the new database.
2. Use the newly created masking definition to initiate masking of the new database. The system responds by validating the masking definition, verifying space availability, then applying the mask formats to the data in the test-staging database.

### **Export and import masking definitions**

This use case applies to the application developer and application database administrator.



1. The developer logs into the system to access databases and their associated privileges.
2. The developer requests the export of a valid masking definition into a transportable file format. The system responds by generating an XML file with the masking definition and mask formats.
3. The database administrator downloads or receives mask templates.
4. The database administrator imports the mask template. The system responds by validating the mask template and creating a masking definition based on the template.
5. The database administrator uses the newly created masking definition to initiate masking of the database. The system responds by validating the masking definition, verifying space availability, then applying the mask formats to the data in the test-staging database.

## Related Oracle Security Offerings

Besides data masking, Oracle offers the following security products:

- **Virtual Private Database or Oracle Label Security** — Hides rows and data depending on user access grants.
- **Transparent Data Encryption** — Hides information stored on disk using encryption. Clients see unencrypted information.
- **DBMS\_CRYPTO** — Provides server packages that enable you to encrypt user data.
- **Database Vault** — Provides greater access controls on data.

## Maintaining Databases

You can use Oracle Enterprise Manager to control the flow of data between or outside Oracle Databases. The following sections provide an overview of the functions available to you that can help you maintain your Oracle Database.

### Using Backup

Backup of an Oracle Database generally refers to physical backup; protecting the files that make up your database. The files protected by the backup and recovery facilities built into Oracle Enterprise Manager include datafiles, control files, and archived redo log files. The backup mechanisms that work at the physical level protect against damage at the file level, such as the accidental deletion of a datafile or the failure of a disk drive. The focus in Oracle backup and recovery is generally on the physical backup of database files, which permit the full reconstruction of your database.

Enterprise Manager's physical backup and recovery features are built on Oracle's Recovery Manager (RMAN) command-line client. Enterprise Manager carries out its backup tasks by composing RMAN commands and sending them to the RMAN client. Enterprise Manager makes available much of the functionality of RMAN, as well as wizards and automatic strategies to simplify and further automate implementing RMAN-based backup and recovery.

Managing backups consists of two things: managing the backups themselves as they exist on disk or tape, and managing the record of backups kept in the RMAN repository.

Datafiles or archived redo logs copied at the operating system level can be cataloged and added to the RMAN repository, after which they can be used in data restore and recovery operations just as if they had been created with RMAN. Backup maintenance provided in Enterprise Manager includes the following:

- Viewing lists of backups (backup sets and image copies) recorded in the RMAN repository
- Cross-checking your repository, which marks as expired any backups that are in the repository but not accessible at the time of the crosscheck
- Deleting expired backups from your RMAN repository
- Deleting obsolete backups from the repository and from disk. Note that if you use a recovery area for your backup storage, many maintenance activities are reduced or eliminated because of the flash recovery area's automatic management of disk space.

## Recovery

Media recovery using Enterprise Manager can be either complete recovery or point-in-time recovery. In complete recovery, all changes from the logs are applied and the database returns to its state at the time of failure. You can then reopen the database with no loss of data.

In point-in-time recovery, you can choose any System Change Number (SCN) between the time of the datafile backup and the last change in the redo logs, and apply only changes up through that SCN. You can thus return your database to any SCN (and thus any point-in-time) between the time of your backup and the most recent SCN in the redo logs. This technique can be used to recover from situations such as user errors that cause logical corruption in the database. Point-in-time recovery is sometimes referred to as incomplete recovery, since not all changes are applied.

Media recovery requires a control file, datafiles, and all online and archived redo logs from the time the datafiles were backed up. It is typically used only in the case of database failure.

Crash recovery is used to recover from a failure either when a single-instance database crashes, or all instances of an Oracle RAC database crash. Instance recovery refers to the case where a surviving instance recovers a failed instance in an Oracle RAC database. Datafile media recovery is used to recover from a lost or damaged current datafile or control file. Block media recovery is a technique for restoring and recovering individual data blocks while all database files remain online and available.

## Flashback Recovery

Enterprise Manager's flashback features provide a range of physical and logical data recovery tools as efficient, easy-to-use alternatives to physical and logical backups. Flashback table allows you to revert a table to its contents at a time in the recent past; and flashback drop allows you to rescue dropped database tables. Neither requires advance preparation such as creating logical-level exports to allow for retrieval of your lost data, and both can be used while your database is available.

Flashback database lets you quickly recover an Oracle Database to a previous time to correct problems caused by logical data corruptions or user errors. If a flash recovery area is configured, then you can return the database to a prior time. Flashback table lets you recover tables to a specified point in time. You can restore table data along with all its associated attributes, such as indexes, triggers, and so on. This is done while the database is online by rolling back only the changes to the given tables. You

can revert the table and its contents to a specific time or user-specified SCN. Use flashback table with flashback query and row versions to find a time to which the table should be restored.

The larger the flash recovery area, the more useful it becomes. Ideally, the flash recovery area should be large enough to hold two complete backup copies of your datafiles, plus any incremental backups and archive logs required to restore your database to any point in time during your recovery window.

## Backup and Recovery Settings

You can use Enterprise Manager to configure a number of settings and policies that determine how backups are stored, which data is backed up, how backups perform, and how long backups are retained before being purged from the recovery area. You can also configure settings to improve backup performance. For disks, you can configure the default format for storing backups, the location on disk where backups are stored, and whether backup tasks are run in parallel for improved performance. Oracle backups to disk can be saved as image copies or backup sets. Backups to tape and similar media management devices must be stored as backup sets.

## Managing Restore Points

You can use Enterprise Manager to create a restore point as a designated point in time to which you can restore your database. A restore point is a name associated with a past point-in-time of the database. You can flash back the database to a restore point if the required flashback logs and archived logs exist. A Guaranteed Restore Point is a restore point to which you can always flash back the database. Each restore point has a name and creation time. The restore points are sorted by creation time beginning with the most recent.

## Overview of Data Guard

Oracle Data Guard ensures high availability, data protection, and disaster recovery for enterprise data. Data Guard provides a comprehensive set of services that create, maintain, manage, and monitor one or more standby databases to enable production Oracle Databases to survive disasters and data corruptions. Data Guard maintains these standby databases as transactionally consistent copies of the production database. Then, if the production database becomes unavailable because of a planned or an unplanned outage, Data Guard can switch any standby database to the production role, thus minimizing the downtime associated with the outage.

Data Guard can be used with traditional backup, restoration, and cluster techniques to provide a high level of data protection and data availability. With Data Guard, administrators can optionally improve production database performance by offloading resource-intensive backup and reporting operations to standby systems.

Enterprise Manager provides comprehensive Data Guard setup, management, and monitoring capabilities, including:

- Automated creation of physical, logical, and snapshot standby databases
- Monitoring of Data Guard status and performance
- Management of key Data Guard features, such as protection modes, switchover, failover, and fast-start failover

## Additional Maintenance Features

Enterprise Manager allows you to easily move data from files or databases into an existing database. You can export and import data, and you can clone databases using the tools available in Enterprise Manager. The following sections describe the features available in the Maintenance area of the Database Home page.

### Exporting and Importing Features

The Export to Files feature enables you to move existing data in Oracle format to and from Oracle Databases. For example, export files can archive database data or move data among different Oracle Databases that run on the same or different operating systems. Using Export to Files, you can back up logical database objects while the database is open and available for use. It writes a read-consistent view of the database's objects to an operating system file. The full database export excludes some schemas and therefore does not include all database objects. The following system schemas are not exported as part of a full export because the metadata they contain is exported as part of other objects in the dump file set: SYS, ORDSYS, EXFSYS, MDSYS, DMSYS, CTXSYS, ORDPLUGINS, LBACSYS, XDB, SI\_INFORMTN\_SCHEMA, DIP, DBSNMP, and WMSYS.

For more information about exporting files, see the *Moving Data Using Data Pump and Export/Import* chapter in the *Oracle Database Upgrade Guide 11g Release 2*. For more information about Data Pump see the *Data Pump Export* chapter in *Oracle Database Utilities 11g Release 2*.

Conversely, you can use Enterprise Manager to import the contents of a database, objects, and tables. You can also import the contents of a database by using the Import from Database feature. You can import an entire database, schemas within a database and the objects in the schemas, or one or more tables from within a schema. Use the Load Data from File feature to load data from a non-Oracle database into an Oracle Database.

Use the Monitor Export and Import Job feature to view the status of an import and export operation such as a full database export or a tablespace export. You can change the state of a job by suspending it, canceling it, or resuming it if it had previously been suspended. You can also increase the number of threads dedicated to the job and thus increase its resources.

### Cloning Databases

You can use the Enterprise Manager Clone Database tool to clone an Oracle Database instance to an existing Oracle home. After you have an Oracle Database instance in a known state, you may want to clone that database to another existing Oracle home.

### Transporting Tablespaces

Use the Transport Tablespaces feature to transport tablespaces between different machine architectures and operating systems. Transportable tablespaces entirely bypass the unload and reload steps. Using transportable tablespaces, Oracle data files (containing table data, indexes, and almost every other Oracle Database object) can be directly transported from one database to another. You can use the transportable tablespaces feature to move a subset of an Oracle Database and plug it in to another Oracle Database, essentially moving tablespaces between the databases.

---

---

**Note:** The Integrate TTS wizard fails when reading header information while attempting to integrate into an 11.2.0.1.0 database target monitored by a 10.2.0.5 Agent configured with an 11.1 GC OMS.

Use the following workaround:

Copy:

```
$OMS_HOME/sysman/admin/scripts/db/dataUtilities/tts.pl
```

to:

```
$AGENT_HOME/sysman/admin/scripts/db/dataUtilities/tts.pl
```

---

---

## Overview of Oracle Streams

Oracle Streams enables the propagation and management of data, transactions, and events in a data stream either within a database, or from one database to another. The stream routes publish information to subscribed destinations. As users' needs change, they can simply implement a new capability of Oracle Streams, without sacrificing existing capabilities.

Oracle Streams can stream data between databases, nodes, or blade farms in a grid and can keep two or more copies in sync as updates are applied. It also provides a unified framework for information sharing, combining message queuing, replication, events, data warehouse loading, notifications, and publish/subscribe into a single technology.

Oracle Streams provides a set of elements that lets users control what information is put into a stream, how the stream flows or is routed from node to node, what happens to events in the stream as they flow into each node, and how the stream terminates. By specifying the configuration of the elements acting on the stream, you can address specific requirements, such as message queuing or data replication.

Use the Streams Management features in Oracle Enterprise Manager to set up, manage, monitor, and troubleshoot your Oracle Streams environment.

## Working with Software Configurations

The Oracle Management Agent on a host collects host configuration information for the host and database configuration information for the Oracle Databases on the host and client configuration information and communicates that information over HTTPS to the Oracle Management Service, which stores it in the Oracle Management Repository. Enterprise Manager lets you compare these configurations to determine differences between two or more hosts, clients or databases. The Generic Compare feature allows you to compare various types of current/saved configurations with one or more current/saved configurations.

Using this feature, you can compare the current configuration of a selected target type with one or more current configurations of other targets of the same type, or compare saved configurations with one or more saved configurations of the same or other targets. You can also compare saved configurations with one or more current configurations of the same or other targets, or compare a specific configuration with another configuration and list the differences immediately. Lastly, you can compare a specific configuration with another configuration and schedule the comparison as a job.

## Using Database Software Patching

Use Enterprise Manager to simplify the patching of Oracle software on any host where an Oracle Management Agent is running, and to provide critical patch advisories. Enterprise Manager simplifies the process of patching Oracle software. Oracle Patch Advisories describe critical software patches for Oracle products. To help ensure a secure and reliable configuration, all relevant and current critical Oracle patches should be applied. To promote critical patch application, Enterprise Manager performs an assessment of vulnerabilities by examining the host configurations collected for your enterprise to determine the Oracle homes that require one or more critical patches to be installed. All the Critical Patch Advisories are listed with their corresponding Impact areas, a brief description of each advisory, the number of Affected Hosts, and Oracle homes for each advisory.

You can connect to *My Oracle Support* via Enterprise Manager, perform a search, download the required patches/patch sets, and apply the patches. You can perform all the patching activities from the Patch Cache. That is, even when the OMS is not connected to *My Oracle Support* via the Internet, you can perform a search, download, and apply a patch/patch set.

## Monitoring Oracle Real Application Clusters

Oracle Real Application Clusters (RAC) provides a high-availability database environment spanning multiple hosts. Each cluster can be comprised of multiple cluster databases, each of which consists of multiple cluster database instances. A cluster database is available as long as one of its instances is available.

Enterprise Manager provides performance pages to monitor all levels of a cluster environment, including the cluster, the cluster database, and the cluster database instances. Managing Oracle Real Application Clusters databases and instances is similar to managing single-instance databases. Using Enterprise Manager, you can perform various tasks, such as:

- Managing clusters, cluster databases, and cluster database instances
- Monitoring key performance statistics
- Performing administration and maintenance tasks
- Managing Oracle Real Application Clusters features, such as Cluster Managed Database Services

Oracle RAC enables each computer (or host) that is a member of the cluster to share access to the database. If one cluster host fails or is taken offline, the other hosts of the cluster continue operating, and the entire Oracle RAC database remains available for applications. This means that two or more computers with typical performance appear to applications as if they were a much more powerful computer.

To increase performance, availability, and reliability of a two-host Oracle RAC database, you can add cluster hosts. Because data is not partitioned between hosts, adding hosts to the cluster does not create instability; instead, applications can run faster or support more users. The more hosts your Oracle RAC database has, the less the loss of any individual node affects the database.

## Cluster Cache Coherency

Concurrent read and write activity on shared data in a cluster occurs frequently. Depending on the service requirements, this activity does not normally cause performance problems. However, when global cache requests cause a performance

problem as indicated on the Cluster Database page, a successful strategy for performance tuning is to optimize SQL plans and the schema to achieve effective local cache hit efficiency and minimize I/O. To assist you in resolving the problem, the Cluster Cache Coherency page enables you to view cache coherency metrics for the entire cluster database, identify processing trends, and optimize performance for your Oracle Real Application Clusters environment (Figure 6–17).

You can access the Cluster Cache Coherency page by clicking the Cluster Cache Coherency link in the Additional Monitoring Links section.

**See Also:** "Cluster Cache Coherency Page" in the Enterprise Manager online help

**Figure 6–17 Cluster Cache Coherency Page**

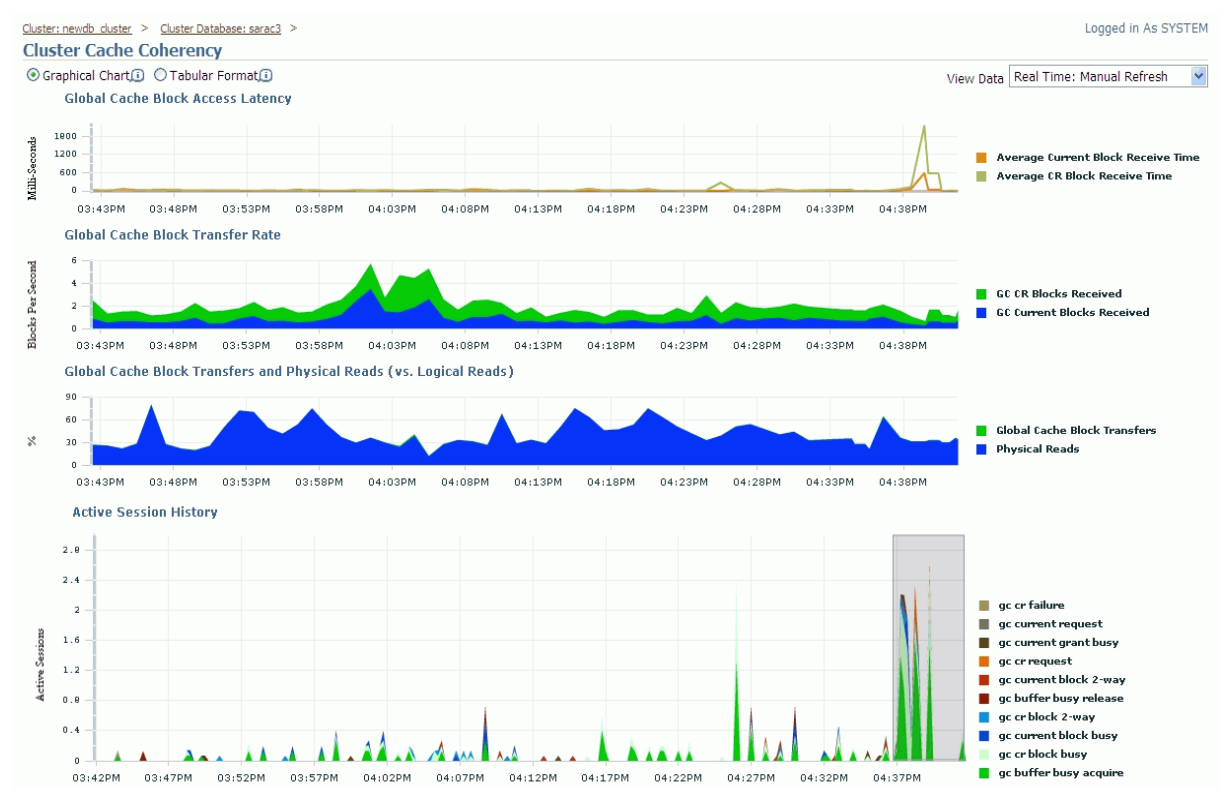

The charts have the following purposes:

- **Global Cache Block Access Latency** represents the end-to-end elapsed time or latency for a block request.
- **Global Cache Block Transfer Rate** shows the total aggregated number of data blocks received by all instances in the cluster through an interconnect.
- **Global Cache Block Transfers and Physical Reads** shows the percentage of logical reads that read data from the buffer cache of other instances through Direct Memory Access and from disk.

- Active Session History** represents the active sessions for the cluster wait classes shown. You can view the top SQL and top sessions for a time period in the tables below by moving the grey shaded box in this chart to the desired time period.

## Cluster Interconnects

The Cluster Interconnects page enables you to view the current state of interfaces on hosts (Figure 6–18). You can use this page to monitor the interconnect interfaces, determine configuration issues, and identify transfer rate-related issues, such as excess traffic. This page helps determine the load added by individual instances and databases on the interconnect. Sometimes, you can immediately identify interconnect delays due to applications outside the Oracle Database.

**See Also:** "Cluster Interconnects Page" in the Enterprise Manager online help

Figure 6–18 Cluster Interconnects Page

Cluster: stbdq-cluster Latest Data Collected From Target Jan 15, 2010 12:14:51 PM

Home Performance Targets Administration Interconnects Topology

The interconnect configuration and internode communication will influence the performance of cluster databases. The tables below show network interfaces on all hosts and network interfaces by cluster databases. It is important that cluster databases are configured to use a private interconnect for message and block transfers.

View Data

Private Interconnect Transfer Rate (MB/Sec) 0.089 \*  
Transfer rate on the private network in the last 5 minutes.

**Interfaces by Hosts**

View

Name	Type	Subnet	Interface Type	Total I/O Rate (MB/Sec) (Last 5 Minutes)	Total Error Rate (%)
stbdq-cluster	Cluster				
stbdq16.us.oracle.com	Host				
eth1	Interface	152.68.80.0	Private	.19 *	
stbdq17.us.oracle.com	Host				
eth1	Interface	152.68.80.0	Private	.038 *	

**Interfaces in Use by Cluster Databases**

Name	Target Type	Interface Name	Host Name	IP Address	Interface Type	Source	Transfer Rate (MB/Sec)
pdbase	Cluster Database						
pdbase1	Database Instance	eth1	stbdq16.us.oracle.com	152.68.82.14	Private	Oracle Cluster Repository	
pdbase2	Database Instance	eth1	stbdq17.us.oracle.com	152.68.82.15	Private	Oracle Cluster Repository	

**TIP** The Transfer Rate is the estimated traffic contributed by the instance assuming uniform block size in the database.

**TIP** \* indicates the data that is more than 10 minutes old.

Home Performance Targets Administration Interconnects Topology

**Hosts**

Name	Status	Clusterware Status	Alerts	Policy Violations	Compliance Score (%)	ASM Instance	CPU Util %	Mem Util %
stbdq16.us.oracle.com	↑	↑	0 2	89 2 0	77	+ASM1 stbdq16.us.oracle.com	13.08	85.35
stbdq17.us.oracle.com	↑	↑	0 3	82 2 0	77	+ASM2 stbdq17.us.oracle.com	16.09	88.37

## Cluster-Managed Database Services

Services are groups or classifications of applications that comprise business components that extend and respond to application workloads. Examples of services are Accounts Payable, Customer Relationship Management, and so on. Services in Oracle RAC enable continuous, uninterrupted database operations to support multiple services on multiple instances.

Services enable Oracle RAC to integrate cluster database resources into a single system image to optimize cluster manageability. This simplifies system deployment, testing, disaster recovery, and administrative overhead. With services, users connect to a database without regard for which instance executes the SQL application service.



You assign services to run on one or more instances, and alternate instances can serve as backup instances in case the primary instance fails. If a primary instance fails, Oracle moves the service from the failed instance to a surviving alternate instance.

Services enable you to model and deploy both planned and unplanned operations for all types of high availability or disaster recovery scenarios. During outages, Oracle RAC automatically restarts key components. Components that are eligible for automatic restart include instances, Oracle Net Services listeners, and the database as well as several database subcomponents.

You can create and edit services using the Create Services page in Enterprise Manager, which you can access from the Cluster Managed Database Services link in the Enterprise Manager Availability property page (Figure 6–19).

**See Also:** "Create Service Page" in the Enterprise Manager online help

**Figure 6–19 Create Service Page**

**Create Service**  
Define a highly available service by specifying preferred and available instances. You can also specify service properties to customize failover mechanisms, monitoring thresholds and resource management.

\* Service Name

Start service after creation  
 Update local naming parameter (tnsnames.ora) file

**High Availability Configuration**

Instance Name	Service Policy
rtest1	Preferred
rtest2	Preferred

**TIP** Must select at least one preferred instance.

**Service Properties**

Transparent Application Failover (TAF) Policy

Enable Distributed Transaction Processing  
Choose this option for all Distributed transactions including XA, JTA. Services with exactly one preferred instance can enable this.

Connection Load Balancing Goal  Short  Long  
Load balance connections based on elapsed time (Short) or number of sessions (Long).

**Notification Properties**

Enable Load Balancing Advisory  
 Service Time  Throughput  
Enable advisory for load balancing based on service quality.

Enable Fast Application Notification (FAN) for OCI and ODP.NET Applications

**Service Threshold Levels**  
If thresholds are specified, alerts will be published when the service elapsed response time and/or CPU time exceed the threshold.

	Warning	Critical
Elapsed Time Threshold (milliseconds)	<input type="text"/>	<input type="text"/>
CPU Time Threshold (milliseconds)	<input type="text"/>	<input type="text"/>

**Resource Management Properties**  
Associate this service with a predefined consumer group or job class.

Consumer Group Mapping

Job Scheduler Mapping

## Policy-managed and Administrator-managed Databases

When you create an Oracle RAC database that is a policy-managed database, you specify the number of servers that are needed for the database, and a server pool is automatically created for the database. Oracle Clusterware populates the server pool with the servers it has available. If you do not use server pools, you can create an administrator-managed database.

You can define services for both policy-managed and administrator-managed databases.

### ■ Policy-managed Database

When you define services for a policy-managed database, you assign the service to a server pool where the database is running. You can define the service as either

uniform (running on all instances in the server pool) or singleton (running on only one instance in the server pool).

- **Administrator-based Database**

When you define a service for an administrator-managed database, you define which instances normally support that service. These are known as the PREFERRED instances. You can also define other instances to support.

---

**See also:** *Oracle Database 2 Day + Real Application Clusters Guide* for more information on policy-based and administrator-based databases, including "Creating an Instance on the New Node."

---

## Oracle Clusterware and High Availability

When you combine Oracle Clusterware and Oracle RAC, you can achieve excellent scalability and high availability. To maintain high availability, the Oracle Clusterware components can respond to status changes to restart applications and processes according to high availability rules you can specify in the Create Service page (Figure 6-19). Oracle Clusterware achieves high availability with the components in Table 6-2.

**Table 6-2 Oracle Clusterware High Availability Components**

Component	Description
Voting Disk	The voting disk manages cluster membership by using a health check, and arbitrates cluster ownership among the instances in case of network failures. Oracle RAC uses the voting disk to determine which instances are members of a cluster.
Oracle Clusterware Registry	The OCR maintains database and cluster database configuration information as well as configuration information about any cluster database within the cluster. The OCR also manages information about processes that Oracle Clusterware controls.
Application Programming Interface	Oracle Clusterware provides a high availability application programming interface (API) that you can use to manage applications or processes that run on single-instance Oracle databases or Oracle RAC databases. This enables you to provide high availability for all of your applications.

## Database High Availability

The Database High Availability Console is a one-stop, dashboard style page for monitoring your database high availability (HA). You can use the High Availability Console page to display high availability events, view the availability summary that includes the status of the database, view the last backup status, view the Flash Recovery Area Usage, view the Data Guard summary, and view the RAC Services summary including Top Services. You can view the Database High Availability Console page in Advanced View or Basic View, depending on how much detail you want to display.

You can use the Database High Availability Console Options page to set up event options for availability events, configure formatting options for the header bar and target and host names, define refresh options on the High Availability Console page, and specify whether and how to display historical charts.

You can use the Database Maximum Availability Architecture (MAA) Advisor page to view recommended Oracle solutions for each outage type (computer failures, storage failures, human errors, data corruptions, and site failures), view configuration status

and Enterprise Manager links for each solution, and view the benefits for each of the solutions that are offered. The MAA Advisor page contains a table that lists the Outage Type, Oracle Solution, Recommendation Level, Configuration Status, and Benefits. You can navigate to a page where you can set up, manage and configure the specific solution area. Once a solution has been configured, you can click on the Advisor Details link to see the updated values.



---

---

# Change Management for Databases

This chapter introduces the concept of change management in the following sections:

- [Overview of Change Management for Databases](#)
- [Dictionary Baselines](#)
- [Dictionary Comparisons](#)
- [Dictionary Synchronizations](#)

## Overview of Change Management for Databases

To manage the lifecycle of enterprise applications, an organization will need to maintain multiple copies of an application database for various purposes such as development, staging, production, and testing. Each of these databases must adhere to different processes. For example, for production databases, it is essential to ensure adherence to proper production control procedures. It is vital that administrators have the tools to detect unauthorized changes, such as an index being dropped without the requisite change approvals. In such cases, monitoring changes to production databases day over day or week over week becomes vital.

Database compliance, that is, ensuring that all databases meet the gold standard configuration, is another important aspect of life cycle management. Compliance with organizational standards or best practices ensures database efficiency, maintenance, and ease of operation.

On development databases, developers make changes that the database administrator needs to consolidate and propagate to staging or test databases. The goal is to identify the changes made to development and then make the same changes to staging or test databases taking into account any other changes already in production database.

Typically, most applications will get upgraded over time. Also, most applications are customized by the business user to suit their needs. Application customizations are usually dependent on database objects or PL/SQL modules supplied by the application vendor. The application vendor supplies the upgrade scripts and the customer has very little transparency about the impact of the upgrade procedure on their customizations. When customers test upgrade databases, they can capture a baseline of the application schema before and after the upgrade. A comparison of the before and after baselines will tell the user what modules were changed by the application. This gives them a better idea about how their customizations will be impacted as a result of upgrading their application.

There are three core capabilities of Change Management that allow developers and database administrators to manage changes in database environments:

- **Baseline** - A point in time of the definition of the database and its associated database objects.
- **Comparison** - A complete list of differences between a baseline or a database and another baseline or a database.
- **Synchronization** - The process of promoting changes from a database definition capture in a baseline or from a database to a target database.

For database versions 9.x and above, the user logged into the database target through Enterprise Manager must have `SELECT ANY DICTIONARY` privilege and `SELECT_CATALOG_ROLE` role for capturing or comparing databases. In addition to the `SELECT ANY DICTIONARY` privilege and `SELECT_CATALOG_ROLE` role, the user logging into the destination database for creating dictionary synchronization needs to be a database administrator (DBA) or must have appropriate privileges on the objects being synchronized.

## Dictionary Baselines

A dictionary baseline contains a set of database definitions captured at a certain point in time. Baselines are stored in the Enterprise Manager repository, and are in the form of an XML document called Simple XML or SXML.

Each baseline must be assigned a unique name. A good practice to name baselines is to match it on the scope of the database objects being captured in the baseline, for example, Financial 11.5.10 or HR Benefits or PO Check Print. A baseline can have a series of versions that have been captured at different points in time. Creating multiple versions of a baseline allows you to track changes to the definitions of a set of database objects over time. You can compare two versions of the same baseline to see the changes that have occurred between them.

When creating a baseline, you also create a corresponding baseline scope specification, which describes the names and the types of database objects and schemas from which they should be captured. When you have created the baseline definition, you can then capture the first version of the baseline by submitting an Enterprise Manager job. At a later time, or at regular intervals, you can capture additional versions of the same baseline. Each baseline version records the metadata definitions as they exist at the time the version is captured.

## Scope Specification

A scope specification identifies the database objects to be captured in a baseline. (Scope specifications also identify objects to process in dictionary comparisons and synchronizations.) Once you have specified the scope of a baseline, you cannot change the scope specification. This restriction ensures that all versions of the baseline are captured using the same set of rules, which means that differences between versions result from changes in the database, not scope specification changes. To capture dictionary objects using a different scope specification, you must create a new baseline.

Baseline scope specifications take three forms.

- You can specify schemas and object types to capture. For example, you can capture all Tables, Indexes and Views in schemas APPL1 and APPL2. This form of scope specification is appropriate when there is a well-defined set of schemas that contain your application objects. In addition to schema objects, you can also capture non-schema objects (such as Users, Roles and Tablespaces) and privilege grants to Users and Roles.

- You can specify schemas to exclude, and object types. This form of scope specification captures objects that are contained in all schemas other than those you specify. For example, you can capture all object types in schemas other than SYSTEM and SYS. This form of scope specification is appropriate when you want to capture all database objects, with the exception of objects contained in Oracle-provided schemas. As with the first form of scope specification, you can also capture non-schema objects and privilege grants.
- Finally, you can capture individual schema objects by specifying the type, schema and name of each object. This form of scope specification is appropriate when you want to capture a few specific objects, rather than all objects contained within one or more schemas. While capturing individual schema objects, you can also capture non-schema objects and privilege grants.

If you include a non-schema object type, such as User or Role, in a scope specification, all objects of that type are captured. There is no way to capture individual non-schema objects. [Figure 7-1](#) shows the Dictionary Baselines:Objects page where the scope can be specified.

**Figure 7-1** *Baseline Scope Specification in the form Of Schemas And Object Types to Capture*

The screenshot displays the 'Create Dictionary Baseline: Objects' page. At the top, a progress bar shows four steps: Source, Objects (selected), Job Options, and Review. Below the progress bar, the page title is 'Create Dictionary Baseline: Objects'. The source database is 'appdb1' and the user is 'system'. Navigation buttons include 'Cancel', 'Back', 'Step 2 of 4', and 'Next'.

The main section is titled 'Specify which database objects you want to capture.' It is divided into two sections:

- Non-Schema Object Types:** Includes checkboxes for 'Tablespace', 'Rollback Segment', 'User' (checked), 'Role' (checked), 'Profile', and 'Grants for Users and Roles' (checked).
- Schema Objects:** Includes an 'Object Selection Method' dropdown set to 'Select object types and the schemas to include'. Below this, there are two columns of object types with checkboxes:
  - Table (checked), Index (checked), View (checked), Trigger (checked), Sequence (checked)
  - Package (checked), Package Body (checked), Procedure (checked), Function (checked), Cluster (unchecked)
  - Database Link (unchecked), Materialized View (unchecked), Materialized View Log (unchecked), Private Synonym (unchecked), Public Synonym (unchecked)
  - User Defined Type (unchecked)

Below the schema objects section is the 'Schemas to Include' section, which contains a table with columns for 'Schema' and 'Remove'. The table lists 'HR' and 'SCOTT' schemas, each with a 'Remove' button. There are also 'Remove All' and 'Add' buttons above the table.

At the bottom of the page, there is an 'Object Name Prefix' section with a dropdown arrow. Below that is the 'Database Attributes' section with a checkbox for 'Initialization Parameters'. Navigation buttons 'Cancel', 'Back', 'Step 2 of 4', and 'Next' are at the bottom right. A footer contains links: Home | Targets | Deployments | Alerts | Compliance | Jobs | Reports | Setup | Preferences | Help | Logout.

## Capturing a Dictionary Baseline Version

As the final step of defining a baseline, you specify when to capture the first version of the baseline. You can capture the first version immediately, or at a later time (for example, when the database is not being used in active development work). You can also indicate that additional versions of the baseline should be captured at regular intervals without further intervention on your part.

You can also capture a new baseline version at any time by selecting the baseline and specifying "Recapture Now."

Baselines processed after the initial version generally complete substantially faster than the initial version. Only those objects that have changed are captured in the new version. This also means that the storage required for additional baseline versions is only slightly larger than the storage used by the initial version, assuming a small percentage of objects has changed. [Figure 7–2](#) shows the first version of a dictionary baseline.

**Figure 7–2 A Baseline Viewed After Completion of the Capture of the First Version**

The screenshot displays the Oracle Dictionary Baselines configuration page for a baseline named "my baseline". The interface includes the following sections:

- Source Database:** appdb1
- Owner:** SYSMAN
- Description:** This is an example baseline.
- Scope Specification:**
  - Type:** Table, Index, View, Trigger, Package, Package Body, Procedure, Function, Sequence, User, Role
  - Schemas to Include:** HR, SCOTT
  - Grants for Users and Roles:** Yes
  - Initialization Parameters:** No
- Versions:** A table showing the first version of the baseline.
 

Select	Version	Objects	Creation Date	Job Status	DDL
<input type="radio"/>	1	106	Jan 7, 2009 1:27:24 AM (UTC-08:00)	Succeeded	Not Generated

At the bottom of the page, there is a navigation menu with links for Home, Targets, Deployments, Alerts, Compliance, Jobs, Reports, Setup, Preferences, Help, and Logout.

## Working With A Dictionary Baseline Version

Within a single dictionary baseline version, you can examine individual object attributes, generate DDL for individual objects, and generate DDL for all the objects in the baseline version. You cannot modify object definitions captured in baseline versions, since they are intended to represent the state of objects at a particular point in time.

- Viewing a baseline object displays the object's attributes graphically.
- Selecting a baseline object and specifying "Generate DDL" displays the DDL used to create the object. [Figure 7–3](#) shows the DDL generated for a baseline object.



**Figure 7-3 DDL Generated for a Selected Baseline Object**

```

Dictionary Baselines > Baseline: my baseline > Baseline: my baseline[1] >
Generate DDL: EMP

CREATE TABLE "SCOTT"."EMP"
(
  "EMPNO" NUMBER(4,0) NOT NULL ENABLE,
  "ENAME" VARCHAR2(10),
  "JOB" VARCHAR2(9),
  "MGR" NUMBER(4,0),
  "HIREDATE" DATE,
  "SAL" NUMBER(7,2),
  "COMM" NUMBER(7,2),
  "DEPTNO" NUMBER(2,0)
) PCTFREE 10 PCTUSED 40 INITRANS 1 MAXTRANS 255 NOCOMPRESS LOGGING
STORAGE(INITIAL 16384 NEXT 16384 MINEXTENTS 1 MAXEXTENTS 505
PCTINCREASE 50 FREELISTS 1 FREELIST GROUPS 1 BUFFER_POOL DEFAULT)
TABLESPACE "SYSTEM" ;

```

Home | [Targets](#) | [Deployments](#) | [Alerts](#) | [Compliance](#) | [Jobs](#) | [Reports](#) | [Setup](#) | [Preferences](#) | [Help](#) | [Logout](#)

- Selecting a baseline version and specifying "Generate DDL" generates the DDL for all objects in the baseline version. While an effort is made to create objects in the correct order (for example, creating tables before indexes), the resulting DDL cannot necessarily be executed on a database to create the objects in the baseline version. For example, if you capture all the schema objects contained in schema APPL1, then try to execute the baseline version DDL on a database that does not contain User APPL1, the generated DDL will fail to execute.

Baseline versions are also used with other Change Management Pack applications, such as Compare and Synchronize. You can compare a baseline version to a database (or to another baseline version). You can also use a baseline version as the source of object definitions in Synchronize, allowing you to re-create the definitions in another database.

## Working With Multiple Dictionary Baseline Versions

When a baseline contains more than one version, you can examine the differences between the versions.

- To see what has changed between a version and the version that precedes it, select the version and specify "View Changes Since Previous Version." The display shows which objects have changed since the previous version (Figure 7-4), which have been added or removed, and which are unchanged. Selecting an object that has changed displays the differences between the object in the two versions.

**Figure 7-4 Viewing Changes Since the Previous Version**

The screenshot shows the Grid Control interface with the following elements:

- Navigation tabs: Home, Targets, Deployments, Alerts, Com.
- Breadcrumbs: Dictionary Baselines > Baseline: my baseline >
- Section: **Changes Since Previous Version: my baseline[2]**
- Metadata:
  - Previous Version: 1
  - Source Database: appdb1
  - Creation Date: Jan 8, 2009 12:33:21 AM (UTC-08:00)
- Section: **Objects Change Summary**
- Summary Table:
 

Unchanged	103	Changed	2	New	1	Removed	1
-----------	-----	---------	---	-----	---	---------	---
- Section: **Objects**
- Search filters: Object Type (All Types), Schema, Object Name, and a Go button.
- Show filter: Changed
- Table of objects:
 

Schema	Name	Type
SCOTT	DEPT	TABLE
SCOTT	EMP	TABLE

- To see how an individual object has changed over all the versions of the baseline, select the object and specify "View Version History." The display identifies the versions in which the object was initially captured, modified, or dropped as shown in Figure 7-5. From this display, you can compare the definitions of the object in any two baseline versions.

**Figure 7-5 Viewing Version History of a Selected Baseline Object**

The screenshot shows the Grid Control interface with the following elements:

- Breadcrumbs: Dictionary Baselines > Baseline: my baseline > Baseline: my baseline[3] >
- Section: **Version History: EMP**
- Metadata:
  - Object Type: Table
  - Schema: SCOTT
  - Baseline: my baseline
  - Source: appdb1
- Section: **Versions**
- Versions Table:
 

Capture Date	Baseline Version	Change Type
Jan 8, 2009 12:53:33 AM (UTC-08:00)	3	New Version
Jan 8, 2009 12:33:21 AM (UTC-08:00)	2	New Version
Jan 7, 2009 1:27:24 AM (UTC-08:00)	1	New Object
- Section: **Compare Object Versions**
- Text: Compare the definitions of this object that were first captured in:
- Form: Left: Baseline Version 1, Right: Baseline Version 3

## Exporting and Importing Dictionary Baselines

You can use the export/import baseline functionality for the following:

- Transferring baselines between two Grid Control sites with different repositories.
- Offline storage of baselines. Baselines can be exported to files, deleted, and then imported back from files.

You can select a dictionary baseline or a version and then export it to a file. The system uses Data Pump for export and import. The dump files and log files are located in the Enterprise Manager repository database server host. They can be located in directories set up on NFS file systems, including file systems on NAS devices that are supported by Oracle.

### Creating Directory Objects for Export and Import

To export a dictionary baseline version from the repository to an export file or import dictionary baselines from an import file on the repository database server, select the directory object in the repository database for the export or import and specify a name for the export or import file.

To create a new directory object for export or import, do the following:

1. Log into the repository database as a user with CREATE ANY DIRECTORY privilege or the DBA role.
2. Create a directory object as the alias for a directory on the repository database server's file system where the baselines are to be exported or where the import dump file is stored.
3. Grant READ and WRITE privileges on the directory object to SYSMAN.

The newly created directory will be available for selection by Enterprise Manager administrators for export and import of dictionary baselines. Data pump log files from the export and import operations are also written to the same directory.

During import, new values can be set for name, owner, and source database. Super administrators can set another administrator as the owner at the time of import.

The export operation does not export job information associated with a baseline. On import, the job status will hence be unknown.

For non-super administrators, the following applies:

- Non-super administrators can export their own baselines. They can also export a version of baseline owned by another administrator, provided they have the privilege to view the version and see the list of dictionary objects in that version.
- At the time of import, a non-super administrator must become the owner of the baseline being imported. A non-super administrator cannot set another administrator as the owner. If the baseline in the import dump file was owned by another administrator, its new owner is set to the logged-in non-super administrator at the time of import.
- View privileges granted on the baseline to non-super administrators are lost during import and cannot be re-granted after the import, since there is no associated job information.

## Dictionary Comparisons

A dictionary comparison identifies differences in database object definitions between a baseline or a database and a baseline or a database, or two schemas within a single database/baseline.

A comparison specification is defined by left and right sources, scope, and owner. The scope specification describes the names and types of database object definitions to be included in the comparison and the schemas that contain these object definitions.

Comparisons identify differences in any attribute value between objects of any type. Use comparisons to create multiple versions of a comparison. Each version has a unique version number and a comparison date. Use these versions to associate comparisons of database/schemas made over time.

**Examples:**

Comparisons show differences between definitions in the original baseline for your application and those in your current database. After creating a new comparison version, it identifies the differences between the original definitions at the start of the development cycle, and those same definitions at the current time.

Use another comparison specification to compare definitions from your most recent baseline with those in your previous baseline. With each newly created version of this comparison using the comparison specification, that comparison version identifies the differences in the definitions since the previous baseline.

## Defining Dictionary Comparisons

A dictionary comparison definition consists of left and right sources for metadata definitions, the scope specification, an optional schema map, and comparison options. Once created, a dictionary comparison definition cannot be modified. This ensures that each version of the dictionary comparison reflects changes in the databases being compared and not in the comparison's definition.

**Dictionary Comparison Sources**

Each comparison has a left source and a right source. The comparison matches object definitions from the left and right sources. A source can be a database or a baseline version.

- When the source is a database, object definitions are taken directly from the database at the time the comparison version is created.
- When the source is a baseline, object definitions are taken from the specified baseline version. Using a baseline version allows you to compare a database (or another baseline version) to the database as it existed at a previous point in time. For example, a baseline version might represent a stable point in the application development cycle, or a previous release of the application.

For baseline sources, there are various ways to specify the version to be used.

- If you want a specific baseline version to be used in all versions of the comparison, specify the baseline version number. This is appropriate for comparing a well-defined previous state of the database, such as a release, to its current state.
- You can also request that the latest or next-to-latest version be used in the comparison. If you specify "Latest," you can also request that the baseline version be captured before the comparison takes place. This option allows you to capture a baseline and compare it to the other source in a single operation. For example, every night, you can capture a baseline version of the current state of a development database and compare it to the previous night's baseline, or to a fixed baseline representing a stable point in development.

## Scope Specification

The scope specification for a dictionary comparison identifies the objects to compare in the left and right sources. Creating a comparison scope specification is the same as creating a baseline scope specification, described in the "Dictionary Baselines" section. As with baselines, you can specify object types and schemas to compare, or individual objects to compare.

## Schema Map

Normally, schema objects in one source are compared to objects in the same schema in the other source. For example, table APPL1.T1 in the left source is compared to APPL1.T1 in the right source.

However, there may be cases where you want to compare objects in one schema to corresponding objects in a different schema. For example, assume that there are two schemas, DEV1 and DEV2, which contain the same set of objects. Different application developers work in DEV1 and DEV2. You can use the optional schema map feature to allow you to compare objects in DEV1 to objects with the same type and name in DEV2.

To add entries to the schema map, expand the "Mapped Objects" section of the comparison "Objects" page. You can create one or more pairs of mapped schemas. Each pair designates a left-side schema and a corresponding right-side schema.

When using a schema map, you can compare objects within a single database or baseline version. In the example above, DEV1 and DEV2 can be in the same database. You specify that database as both the left and right source, and supply the schema map to compare objects in DEV1 to those in DEV2.

## Comparison Options

You can select several options to determine how objects are compared. These options allow you to disregard differences that are not significant. The options include the following:

- "Ignore Tablespace" and "Ignore Physical Attributes" – These two options allow you to compare stored objects without regard to the tablespaces in which they are stored or the settings of their storage-related attributes. This is useful when you are comparing objects in databases having different size and storage configurations, and you are not interested in differences related to the storage of the objects.
- "Match Constraints By Definition" or "By Name" – If you are more interested in the definitions of table constraints – for example, the columns involved in primary or unique constraints – choose "Match Constraints By Definition." This causes constraints with the same definitions to match; their names appear as differences (unless you also choose "Ignore Name Differences"). If the names of constraints are meaningful, choose "Match Constraints By Name." With this choice, constraints with the same names will match and their definitions will appear as differences.
- "Partitioned Objects: Ignore High Values" – Tables that are otherwise the same might have different partition high values in different environments. Choose this option to ignore differences in high values.
- "Logical SQL Compare" – Choose this option to ignore meaningless formatting differences in source objects such packages, package bodies, procedures and functions.
- "Compare Statistics" – Choose this option to compare optimizer statistics for tables and indexes.

- "Ignore Table Column Position" – Choose this option if tables that differ only in column position should be considered equal.

### **Creating Comparison Versions**

When you have finished defining the comparison, you specify when to create the first comparison version. You can create the first version immediately, or at a later time. You can also schedule new comparison versions at regular intervals.

In addition to scheduling comparison versions, you can create a new comparison version at any time by selecting the comparison and specifying "Repeat Now."

Comparisons processed after the initial version generally complete substantially faster than the initial comparison. Only those objects that have changed on the left or right side are compared in the new version. This also means that the storage required for additional comparison versions is only slightly larger than the storage used by the initial version, assuming a small percentage of objects has changed.

### **Working with Dictionary Comparison Versions**

A dictionary comparison version records the results of comparing the left and right sources in accordance with the scope specification. Objects in a comparison version have one of four states:

- Left Only – The object is present only in the left source.
- Right Only – The object is present only in the right source.
- Identical – The object is present in both left and right sources, and is the same.
- Not Identical – The object is present in both left and right sources, and is different.

Figure 7-6 Comparison Version Page Showing a List Of Not Identical Objects

Dictionary Comparisons > Comparison: my comparison >

Comparison: my comparison[1] Printable Page

Left Source: appdb1      Right Source: database\_2  
 Left Type: Database      Right Type: Database  
 Owner: SYSMAN      Creation Date: Jan 8, 2009 1:23:55 AM (UTC-08:00)

**Initialization Parameters**

Identical: 325      Not Identical: 16      Left Only: 0      Right Only: 0

**Objects**

Object Type: Schema  
 All Types

Show: Not Identical - Present in both sources but attributes are not identical Results

Select All | Select None

Select	Schema	Name	Result	Type	Most Recent Comment	Details
<input type="checkbox"/>	OE	CUSTOMERS		TABLE		
<input type="checkbox"/>	HR	DEPARTMENTS		TABLE		
<input type="checkbox"/>	SCOTT	DEPT		TABLE		
<input type="checkbox"/>	SCOTT	EMP		TABLE	Here I can enter a comment such as why this particular table is different.	
<input type="checkbox"/>	HR	EMPLOYEES		TABLE		
<input type="checkbox"/>	HR	JOB_HISTORY		TABLE		
<input type="checkbox"/>	OE	ORDERS		TABLE		
<input type="checkbox"/>		SYSTEM		TABLESPACE		
<input type="checkbox"/>		TEMP		TABLESPACE		

The page lists all versions of a comparison shows the number of objects in each state within each version. On the Comparison version page shown in Figure 7-6, you can see the objects in each state individually. Objects that are "Not Identical" can be selected to view the differences, and to generate DDL for the left and right definitions as shown in Figure 7-7.

**Figure 7-7 Viewing Differences in the Attributes of a Selected Not Identical Object**

Dictionary Comparisons > Comparison: mv.comparison > Comparison: mv.comparison[1] >

**View Differences: EMP** Return

Left Source: **appdb1**      Right Source: **database\_2**  
Object Type: **Table**      Schema: **SCOTT**  
Object Name: **EMP**

**Differences**

[Expand All](#) | [Collapse All](#)

Attributes	appdb1	database_2
Table		
Columns		
EMAIL_ADDRESS		Not Present
Name	EMAIL_ADDRESS	
Data Type	VARCHAR2	
Column Position	9	
Length	100	
Constraints		
Unique Keys		
UK_EMAIL_ADDRESS		Not Present

TIP To view the DDL for the left or right object, click on 'Left DDL' or 'Right DDL' below.

[View Comments](#)

[Left DDL](#)      [Right DDL](#)

You can take two further actions to record information about objects in a comparison version:

- You can add a comment to an object. For example, the comment might explain why two objects are different.
- You can ignore the object. Ignoring the object removes it from lists of comparison version objects. You might ignore an object that is different if you decide that the difference is not important.

## Dictionary Synchronizations

A dictionary synchronization synchronizes differences in database object definitions between two databases or a baseline and a database. The basic action of a database synchronization is to create or modify selected object definitions in a database to match those in another database or in a baseline.

Synchronizations are generated using synchronization specifications. For synchronizations, the scope specification does not include the names of individual objects. It can only specify the types, and the schemas to be included or excluded. You can additionally supply a prefix to limit the objects selected to those whose names start with that prefix.

Dictionary synchronizations synchronize differences in any attribute value between objects of any supported type. Use synchronization specifications to create multiple versions of a synchronization. Each version has a unique version number and a synchronization date. Use these versions to associate synchronizations of database/schemas made over time.



## Defining Dictionary Synchronizations

### Source and Destination

The synchronization source provides the object definitions (and optionally, the data) from which the destination database is synchronized. A synchronization source may be a database, or a baseline version. If the source is a baseline version, it is not possible to propagate data to the destination, since a baseline does not capture data.

The synchronization destination must always be a database. The purpose of synchronization is to create or modify object definitions in the destination to match those in the source.

The options for specifying which version of a source baseline to use are similar to those used with dictionary comparisons. You can specify a fixed baseline version, or "Latest" or "Latest-1". If you specify "Latest," you can also request that the baseline version be captured first before synchronizing the destination from it.

When defining a baseline to be used as the source for synchronization, it is important that the baseline contain all the objects to be synchronized. For this reason, the baseline's scope specification should include at least all the schemas and object types that will be synchronized. The baseline should also include User and Role objects, along with privilege grants. A baseline to database synchronization is recommended in environments where changes are expected to be applied to the source database frequently thus necessitating the need for a point-in-time snapshot of the database, i.e. a baseline as the source of the synchronization.

### Scope Specification

Defining a scope specification for a dictionary synchronization is similar to defining a scope specification for a dictionary baseline or comparison. However, there are restrictions on what you can include in the scope specification.

- You cannot specify individual objects for synchronization. You must specify object types and either schemas to include or schemas to exclude.
- Certain schemas, such as SYS and SYSTEM, cannot be synchronized.
- You cannot directly include User and Role objects for synchronization. (However, Users and Roles are automatically included as needed during the synchronization process.)
- The following object types must be selected as a group: Table, Index, Cluster, Materialized View, and Materialized View Log.

The scope specification for a synchronization should be carefully tailored to the application. Do not include more schemas than are needed. For example, if you are synchronizing a module of a large application, include only those schemas that make up the module. Do not attempt to synchronize a large application (or the entire database) at one time.

### Schema Map

The definition and use of the schema map is the same in dictionary synchronizations as in dictionary comparisons. When you use a schema map, object definitions in each schema map are synchronized to the mapped schema in the destination, rather than to the schema with the same name. In addition, schema-qualified references (other than those contained in PL/SQL blocks and view queries) are changed according to the schema map.

For example, assume the schema map has two entries, as follows:

- DEV1A -> DEV2A
- DEV1B -> DEV2B

Table DEV1A.T1 has an index, DEV1A.T1\_IDX. It also has a foreign key constraint that refers to DEV1B.T2. Synchronize will create objects as follows:

- Table DEV2B.T2
- Table DEV2A.T1, with a foreign key reference to table DEV2B.T2
- Index DEV2A.T1\_IDX, on table DEV2A.T1

### **Synchronization Options**

Dictionary synchronization options are similar to the options you can specify with dictionary comparisons. In synchronization, the options perform two functions:

- During initial comparison of source and destination objects, the options determine whether differences are considered meaningful. For example, if the "Ignore Tablespace" option is selected, tablespace differences are ignored. If two tables are identical except for their tablespaces, no modification to the destination table will occur.
- When generating the script that creates objects at the destination, some options control the content of the script. For example, if "Ignore Tablespace" is selected, no TABLESPACE clauses are generated.

In addition to the options provided with dictionary comparison, the following options are specific to Synchronize:

- "Preserve Data In Destination" and "Copy Data From Source" – These two options control whether table data is copied from the source database to the destination database. (The option is not available if the source is a baseline.) By default, Synchronize preserves data in destination tables. Choosing "Copy Data From Source" causes Synchronize to replace the destination data with data from the source table.
- "Drop Destination-Only Schema Objects" – Choosing this option directs Synchronize to drop schema objects that are present in the destination but not the source. For example, if the source contains table DEV1.T1 and the destination contains DEV1.T1 and DEV1.T2, Synchronize will drop DEV1.T2 if this option is chosen. This action applies only to schema objects that are within the scope specification. By default, Synchronize does not drop destination-only objects. Synchronize never drops non-schema objects.

### **Synchronization Mode**

The next step in defining a synchronization is to choose the synchronization mode. There are two options:

- Unattended synchronization mode carries out the entire synchronization process in one step, ending with execution of the synchronization script. However, if an error is detected that makes it impossible to generate a correct script, the process will terminate without attempting to execute the script.
- Interactive synchronization mode pauses after initial comparison of the source and destination objects, and again after generation of the synchronization script. Interactive mode gives you a chance to examine the results of comparison and script generation, and to take appropriate action before proceeding with the next step.

## Creating Synchronization Versions

When you have finished defining the synchronization, you specify when to create the first synchronization version. You can create the first version immediately, or at a later time. You can also schedule new synchronization versions at regular intervals.

Depending on the synchronization mode you select, the synchronization may run to completion (unattended mode), or pause after initial object comparison (interactive mode). In the latter case, you run each subsequent phase of the synchronization in a new job.

When using interactive mode, the destination database should not be modified from the time the objects are initially compared until the synchronization script has executed. Otherwise, the script may encounter problems. For example, assume the source has a table that the destination does not have. Object comparison notes the source-only table, and the generated script includes statements to create the table. However, after object comparison but before script execution, you manually create the table at the destination database. The script will fail when it attempts to create the table because the table already exists.

Figure 7–8 shows a list of synchronizations.

**Figure 7–8 List of Synchronizations**

The screenshot shows the 'Dictionary Synchronizations' page in a management console. It includes a navigation bar with links for Hosts, Databases, Web Applications, Services, Systems, Groups, and All Targets. Below the navigation bar is a search box with a dropdown menu set to 'Name' and a 'Go' button. A 'Create' button is located in the top right corner of the table area. The table has columns for 'Select', 'Name', 'Source', 'Destination', 'Versions', 'Owner', 'Most Recent Version', 'Most Recent Status', and 'Pending Action'. There are four rows of synchronization data. Below the table, there are 'Related Links' for 'Dictionary Baselines' and 'Dictionary Comparisons'.

Select	Name	Source	Destination	Versions	Owner	Most Recent Version	Most Recent Status	Pending Action
<input checked="" type="radio"/>	my synchronization	appdb1	database_2	1	SYSMAN	Jan 9, 2009 1:34:04 AM (UTC-08:00)	✓ Comparison Succeeded	<a href="#">Generate Script</a>
<input type="radio"/>	reset dict changes	my baseline[1]	database_2	2	SYSMAN	Jan 9, 2009 1:32:32 AM (UTC-08:00)	✓ Execution Succeeded	
<input type="radio"/>	apply dict changes	my baseline [Latest]	appdb1	1	SYSMAN	Jan 9, 2009 1:03:57 AM (UTC-08:00)	✓ Execution Succeeded	
<input type="radio"/>	my incorrect sync	appdb1	database_2	1	SYSMAN	Jan 8, 2009 9:59:18 AM (UTC-08:00)	✗ Generated With Errors	

For more information about the process of synchronization, see [Working with Dictionary Synchronization Versions](#).

## Creating a Synchronization Definition from a Comparison

You can use a dictionary comparison as the starting point for synchronization. Select the comparison, then choose "Synchronize." This creates a new synchronization with the following initial information from the comparison:

- Source and destination, from the comparison's left and right sources, respectively. This means that you cannot create a synchronization from a comparison whose right source is a baseline.

- Scope specification. Note that some comparison scope specification options are not available in a synchronization. For example, you cannot synchronize individual schema objects, User objects, or Role objects.
- Comparison options

## Working with Dictionary Synchronization Versions

Each synchronization version represents an attempt to modify the destination objects selected by the scope specification to match the corresponding source objects. (It is "an attempt" because the process may not complete, for various reasons.) This section describes how a dictionary synchronization version is processed, and how you can monitor and control the process.

### The Dictionary Synchronization Cycle

There are three steps involved in processing a synchronization version. As noted previously, you can combine these steps into one (by choosing "Unattended Mode") or run each step separately (by choosing "Interactive Mode"). In either case, all three steps must be carried out when processing a successful synchronization version.

The following sections detail each of the three steps and describe what you can do following each step, when operating in interactive mode.

#### Object Comparison Step

The first step is to compare objects in the source to corresponding objects in the destination. Only those objects selected by the scope specification are compared. At the end of this step, the synchronization version has recorded all the objects. Each object is in one of the following states:

- Source Only
- Destination Only
- Identical
- Not Identical

In interactive mode, you can view the objects that are in each state, or all objects at once. For objects that are not identical, you can view the differences between the objects. At this stage, you can anticipate what will happen to each destination object:

- Source-only objects will be created in the destination.
- Destination-only objects will be unaffected, unless you chose the "Drop Destination-Only Schema Objects" option, in which case they will be dropped from the destination.
- Identical objects will be unaffected. However, if you chose the "Copy Data From Source" option, the data in tables that are identical will be replaced with data from the source.
- Non-identical objects will be modified to match the source object. Depending on the differences, the modification may be done with ALTER statements or by dropping and re-creating the object.

Before proceeding to script generation ([Figure 7-9](#)), you can exclude objects from the synchronization. For example, if you notice a source-only view that you do not want to create at the destination, you can exclude it now.

Figure 7–9 Continue to Script Generation Step in the Interactive Mode

**Synchronize: Continue To Script Generation** Cancel Continue

Synchronization Name: my synchronization      Version: 1  
 Source Database: appdb1      Creation Date: Jan 9, 2009 1:34:04 AM (UTC-08:00)  
 Destination Database: database\_2      Job Status: Comparison Succeeded  
 Owner: SYSMAN  
 Description: Synchronize database\_2 with changes from appdb1.

Use this page to view comparison results and selectively exclude objects from the synchronization operation. The excluded objects will be ignored during script generation.

Comparison Summary    Source Only > 2    Destination Only < 1    Identical = 38    Not Identical (X) 2

---

Object Type: Schema    Object Name:  Go

Show: All Differences - Source Only, Destination Only and Non-Identical objects    Results

Select All | Select None

Select	Schema	Name	Result	Type
<input type="checkbox"/>	SCOTT	BONUS	<	TABLE
<input type="checkbox"/>	SCOTT	DEPT	(X)	TABLE
<input type="checkbox"/>	SCOTT	EMP	(X)	TABLE
<input type="checkbox"/>	SCOTT	LOCATION	>	TABLE
<input type="checkbox"/>	SCOTT	UK_EMAIL_ADDRESS	>	INDEX

### Script Generation Step

During script generation, Synchronize uses the results of the comparison step to create the PL/SQL script that will create and modify objects at the destination so that it matches the source. As part of script generation, several activities take place:

- Dependency analysis assures that the destination database provides a suitable environment for each object and that objects are created and modified in the correct order.
- Change analysis determines whether an object can be modified with ALTER statements or if it must be dropped and re-created.
- Messages are placed in the impact report for the synchronization version. The messages provide information about the synchronization process, and may report one or more error conditions that make it impossible to generate a usable script.
- The DDL statements needed to carry out the synchronization are generated and recorded in the synchronization version.

Dependency analysis examines each object to determine its relationships with other objects. It makes sure these other objects exist (or will be created) in the destination. Some examples of these relationships are:

- A schema object depends on the User object that owns it. For example, table DEV1.T1 depends on user DEV1.
- An index depends on the table that it is on. For example, index DEV1.T1\_IDX depends on table DEV1.T1.
- A table that has a foreign key constraint depends on the table to which the constraint refers.
- A source object such as a package body depends on other source objects, tables, views, and so on.

- A stored object depends on the tablespace in which it is stored, unless you choose "Ignore Tablespace."

The relationships established during dependency analysis are used later in the script generation process to make sure script statements are in the correct order.

Dependency analysis may determine that a required object does not exist in the destination database. For example, a schema object's owner may not exist in the destination database. Or, a table may have a foreign key constraint on another table that is in a different schema. There are several possible outcomes.

- If the required object is in the source and is selected by the scope specification, Synchronize creates the object. For example, if DEV1.T1 has a foreign key constraint that refers to DEV2.T2, and both DEV1 and DEV2 are in the scope specification, Synchronize creates DEV2.T2.
- If the required object is a user or role, and the object is available in the source, Synchronize automatically includes the user or role and creates it at the destination. This occurs even though User and Role objects are not part of the Synchronize scope specification.
- If a required schema object is in the source but is not selected by the scope specification, Synchronize does not automatically include the object; instead, it places an Error-level message in the impact report. This restriction prevents uncontrolled synchronization of objects outside the scope specification. It is for this reason that scope specifications should include all the schemas that make up the application or module.
- If the source is a baseline version, it may not include the required object. For example, a baseline might not capture Users and Roles. Synchronize cannot look for objects outside the baseline version, so it places an Error-level message in the impact report as shown in [Figure 7-10](#). This is why it is important to include Users, Roles, and privilege grants in any baseline that will be used for synchronization.

**Figure 7–10 Error-level Impact Report Messages Resulting from a Required Schema Object Not Selected by the Scope Specification**

Hosts | Databases | Web Applications | Services | Systems | Groups | All Targets

Dictionary Synchronizations > Synchronization: my incorrect sync >

**View Synchronization: my incorrect sync[1]**

Source Database	appdb1	Creation	Jan 8, 2009 9:59:18
Destination Database	database_2	Date	AM (UTC-08:00)
Owner	SYSMAN	Job Status	<a href="#">Generated With Errors</a>
Description	Example of an incorrect sync attempt where an in-scope view DEV2.V2 refers to an out-of-scope table DEV3.T3. To correct this error, a new sync needs to be created that includes the DEV3 schema as well.	Most Severe Message	<b>✘ Error</b>

Objects | **Impact Report** | Script

Message Summary      Error **✘ 2**      Warning **0**      Information **i 3**

Object Type Schema      Object Name

All Types

Select	Severity	Object Type	Schema	Object Name	Message	Recommended Action
<input checked="" type="radio"/>	✘	TABLE	DEV3	T3	An object that is being synchronized depends on this object, but this object cannot be included because it is out of scope.	Create a new synchronization that includes schema DEV3 and type TABLE so that this table is also synchronized.
<input type="radio"/>	✘	VIEW	DEV2	V2	This view refers to TABLE DEV3.T3, which was not found in the destination or source.	Create a new synchronization that includes table DEV3.T3.
<input type="radio"/>	i	USER		DEV1	This object was included from the source. TABLE DEV1.T1, and possibly other objects, depend on this object.	Make sure that it is appropriate to include this object.
<input type="radio"/>	i	USER		DEV2	This object was included from the source. USER DEV1, and possibly other objects, depend on this object.	Make sure that it is appropriate to include this object.
<input type="radio"/>	i	USER		DEV3	This object was included from the source. USER DEV2, and possibly other objects, depend on this object.	Make sure that it is appropriate to include this object.

At the end of the script generation step, Synchronize has added the impact report and the script to the synchronization version. In interactive mode, you can examine the script and impact report before proceeding to script execution.

The impact report contains messages about situations that were encountered during script generation. There are three types of messages:

- Informational messages require no action on your part. They simply report something of interest. For example, when script generation automatically includes a User object, it adds an informational message to the impact report.
- Warning messages report a situation that requires your attention, but that may not require action. For example, if Synchronize is unable to determine if a reference is a source object can be resolved, it adds a warning message to the impact report. You need to verify that situations reported in warning messages will not prevent script execution.
- Error messages indicate a situation that will prevent script execution if not corrected. For example, if Synchronize is unable to locate a required dependency object, it adds an error message to the impact report. Depending on the message, you may be required to create a new synchronization. For example, if the dependency object is not in the synchronization scope, or if the source is a baseline that does not contain the dependency object, you will need to create a new synchronization with an expanded scope or a different source baseline. In other cases, you can resolve the situation by excluding one or more objects from the synchronization and regenerating the script.

The script display contains the statements of the generated script in the order they will be executed. You can examine the script if you have any concerns about its correctness.

The display allows you to locate statements that are associated with a particular object or object type.

**Figure 7–11 Continuing To Script Execution Step in the Interactive Mode (Impact Report Tab)**

**Synchronize: Continue To Script Execution** Cancel Continue

Synchronization Name **my synchronization** Version **1**  
 Source Database **appdb1** Creation Date **Jan 9, 2009 1:52:59 AM (UTC-08:00)**  
 Destination Database **database\_2** Job Status **Generated With Warnings**  
 Owner **SYSMAN** Most Severe Message **Warning**  
 Description **synchronize database\_2 with changes from appdb1.**

**Impact Report** | Script

Review Impact Report messages for the synchronization operation. Take suggested user actions to correct any errors.

Message Summary Error 0 Warning 2 Information 0

---

Object Type Schema Object Name

Severity	Object Type	Schema	Object Name	Message	Recommended Action
	TABLE	SCOTT	DEPT	Data cannot be preserved appropriately for this table since constraint DEPT_LOC_FK added	Ensure the data values do not violate the constraints
	TABLE	SCOTT	EMP	Data cannot be preserved appropriately for this table since constraint UK_EMAIL_ADDRESS added	Ensure the data values do not violate the constraints

About Oracle Enterprise Manager

Following script generation, you can continue to script execution unless an error was encountered during the script generation step (Figure 7–11 and Figure 7–12). In this case the impact report will contain one or more Error-level messages detailing the problem and solution. In some cases, you may be able to solve the problem by selecting "Regenerate Script," excluding an object from the synchronization, and regenerating the script.



**Figure 7–12 Continuing To Script Execution Step in the Interactive Mode (Script Tab)**

**Synchronize: Continue To Script Execution** Cancel Continue

Synchronization Name: **my synchronization**      Version: **1**  
 Source Database: **appdb1**      Creation Date: **Jan 9, 2009 1:52:59 AM (UTC-08:00)**  
 Destination Database: **database\_2**      Job Status: **Generated With Warnings**  
 Owner: **SYSMAN**      Most Severe Message: **Warning**  
 Description: **synchronize database\_2 with changes from appdb1.**

[Impact Report](#)   [Script](#) Save Full Script

**Search**

Script Line Type:       Object Type:   
 Schema:    
 Object Name:

Script Line Type	Object Type	Schema	Object Name	Script Line	Details
Comment				-- Script Execution Controller	
SQL	TABLE	SCOTT	BONUS	DROP TABLE "SCOTT"."BONUS" PURGE	
SQL	TABLE	SCOTT	LOCATION	CREATE TABLE "SCOTT"."LOCATION" ("LOCATION_ID" NUMBER(4,0), "STREET_ADDRESS" VARCHAR...	
SQL	TABLE	SCOTT	LOCATION	ALTER TABLE "SCOTT"."LOCATION" ADD PRIMARY KEY ("LOCATION_ID") ENABLE	
SQL	TABLE	SCOTT	DEPT	ALTER TABLE "SCOTT"."DEPT" DROP ("LOC")	
SQL	TABLE	SCOTT	DEPT	ALTER TABLE "SCOTT"."DEPT" ADD ("LOCATION_ID" NUMBER(4,0))	
SQL	TABLE	SCOTT	DEPT	ALTER TABLE "SCOTT"."DEPT" ADD CONSTRAINT "DEPT_LOC_FK" FOREIGN KEY ("LOCATION_ID") REFERE...	
SQL	TABLE	SCOTT	EMP	ALTER TABLE "SCOTT"."EMP" ADD ("EMAIL_ADDRESS" VARCHAR2(100))	
SQL	INDEX	SCOTT	UK_EMAIL_ADDRESS	CREATE UNIQUE INDEX "SCOTT"."UK_EMAIL_ADDRESS" ON "SCOTT"."EMP" ("EMAIL_ADDRESS")	
SQL	TABLE	SCOTT	EMP	ALTER TABLE "SCOTT"."EMP" ADD CONSTRAINT "UK_EMAIL_ADDRESS" UNIQUE ("EMAIL_ADDRESS") ENABL...	

There may be cases where you need to create a new version of the synchronization in order to correct the problem. For example, if you need to modify the definition of an object in the source or destination or add an object in the destination, you will need to create a new version. This allows the new or modified object to be detected during the comparison step. In this case, the old version becomes "abandoned" since you cannot continue to script generation.

### Script Execution Step

Following successful script generation, the script is ready to execute. In unattended mode, the script executes as soon as script generation completes. In interactive mode, you proceed to script execution as soon as you have reviewed the impact report and the script.

The script executes in the Enterprise Manager job system. [Figure 7–13](#) shows the output of the Synchronization job. Once script execution is complete, you can view the execution log. If the script fails to execute successfully, you may be able to correct the problem and re-start the script execution from the point of failure. For example, if the script fails due to lack of space in a tablespace, you can increase the size of the tablespace, then re-start the script.

**Figure 7–13 Synchronization Script Execution Step Output of Enterprise Manager Job**

The screenshot displays the 'Job Activity' window for a job named 'Execution:2'. The selected step is 'Synchronization Script Execution'. The status is 'Succeeded' with an exit code of 0. The step ID is 906 and it targets 'database\_2'. The execution started on Jan 9, 2009 at 2:09:37 AM (UTC-08:00) and ended at 2:09:40 AM (UTC-08:00), taking 3 seconds. The management service is 'stapn32.us.oracle.com:7664\_Management\_Service'. A note indicates that the job step was dispatched from the TIP Management Service.

The 'Output Log' section shows the following SQL\*Plus output:

```

SQL*Plus: Release 11.1.0.7.0 - Production on Fri Jan 9 02:09:38 2009

Copyright (c) 1982, 2008, Oracle. All rights reserved.

SQL> Connected.
SQL> -- Script Execution Controller
Starting Synchronization
USER is "SYSTEM"
DROP TABLE "SCOTT"."BONUS" PURGE
CREATE TABLE "SCOTT"."LOCATION"
(
  "LOCATION_ID"
NUMBER(4,0),
  "STREET_ADDRESS" VARCHAR2(40),
  "CITY" VARCHAR2(30) CONSTRAINT
"LOC_CITY_NN" NOT NULL ENABLE,
  "STATE_PROVINCE" VARCHAR2(25),
  "POSTAL_CODE"
VARCHAR2(12)
)
ALTER TABLE "SCOTT"."LOCATION" ADD PRIMARY KEY ("LOCATION_ID") ENABLE
ALTER TABLE "SCOTT"."DEPT" DROP ("LOC")
ALTER TABLE "SCOTT"."DEPT" ADD ("LOCATION_ID" NUMBER(4,0))
ALTER TABLE "SCOTT"."DEPT" ADD CONSTRAINT "DEPT_LOC_FK" FOREIGN KEY
("LOCATION_ID") REFERENCES "SCOTT"."LOCATION"("LOCATION_ID") ENABLE
ALTER TABLE "SCOTT"."EMP" ADD ("EMAIL_ADDRESS" VARCHAR2(100))
CREATE UNIQUE INDEX "SCOTT"."UK_EMAIL_ADDRESS" ON "SCOTT"."EMP"
("EMAIL_ADDRESS")
ALTER TABLE "SCOTT"."EMP" ADD CONSTRAINT "UK_EMAIL_ADDRESS" UNIQUE
("EMAIL_ADDRESS") ENABLE
Completed Synchronization. Starting cleanup phase.
Starting cleanup of recovery tables
Completed cleanup of recovery tables
Starting cleanup of generated procedures
Completed cleanup of generated procedures
Script execution complete
SQL> set ver on
SQL> Disconnected from Oracle Database 11g Enterprise Edition Release 11.1.0.7.0 - Production
With the Partitioning, Data Mining and Real Application Testing options

```

## Creating Additional Synchronization Versions

Following processing of the initial synchronization version, you can create additional versions of the synchronization. Select the synchronization, then choose "Synchronize Again." Note that you cannot choose a different source or destination, or modify the scope specification or synchronization options, when creating a new synchronization version. However, you can choose a different mode (Unattended or Interactive) when starting a new synchronization version.

Creating additional synchronization versions allows you to propagate incremental changes in the source to the destination. For example, you can refresh a test database from the latest changes made to a development system.

Synchronizations processed after the initial version generally complete substantially faster than the initial synchronization.



---

---

# Service Management

This chapter introduces the concepts of services and service management in the following sections.

- [Introduction to Services](#)
- [Modeling Services](#)
- [Managing Systems](#)
- [Monitoring Services](#)
- [Diagnosing Service Problems](#)

## Introduction to Services

The critical and complex nature of today's business applications has made it very important for IT organizations to monitor and manage application service levels at high standards of availability. Problems faced in an enterprise include service failures and performance degradation. Since these services form an important type of business delivery, monitoring these services and quickly correcting problems before they can impact business operations is crucial in any enterprise.

Service-level agreements are used to evaluate service availability, performance, and usage. By constantly monitoring the service levels, IT organizations can identify problems and their potential impact, diagnose root causes of service failure, and fix these in compliance with the service-level agreements.

Enterprise Manager provides a comprehensive monitoring solution that helps you to effectively manage services from the overview level to the individual component level. When a service fails or performs poorly, Grid Control provides diagnostics tools that help to resolve problems quickly and efficiently, significantly reducing administrative costs spent on problem identification and resolution. Finally, customized reports offer a valuable mechanism to analyze the behavior of the applications over time.

Grid Control monitors not only individual components in the IT infrastructure, but also the applications hosted by those components, allowing you to model and monitor business functions using a top-down approach, or from an end-user perspective. If modeled correctly, services can provide an accurate measure of the availability, performance, and usage of the function or application they are modeling.

## Defining Services in Enterprise Manager

A "service" is defined as an entity that provides a useful function to its users. Some examples of services include CRM applications, online banking, and e-mail services.

Some simpler forms of services are business functions that are supported by protocols such as DNS, LDAP, POP, or SMTP.

Grid Control allows you to define one or more services that represent the business functions or applications that run in your enterprise. You can define these services by creating one or more service tests that simulate common end-user functionality. Using these service tests, you can measure the performance and availability of critical business functions, receive alerts when there is a problem, identify common issues, and diagnose causes of failures.

You can define the following service types: Generic Service, Web Application, Forms Application, and Aggregate Service. Web applications, a special type of service, are used to monitor Web transactions. Forms applications are used to model and monitor Forms transactions.

The following elements are important to understanding Grid Control's Service Level Management feature:

- **Service:** Models a business process or application.
- **Availability:** A condition that determines whether the service is considered accessible by the users or not.
- **Service Test:** The functional test defined by the Enterprise Manager administrator against the service to determine whether or not the service is available and performing.
- **System:** A group of underlying components, such as hosts, databases, and application servers, on which the service runs. For more information on systems, refer to the "[Managing Systems](#)" section in this chapter.
- **Beacons:** A functionality built into Management Agents used to pre-record transactions or service tests.
- **Performance and Usage:** Performance indicates the response time as experienced by the end users. Usage refers to the user demand or load on the system.
- **Service Level:** Operational or contractual objective for service availability and performance.
- **Root Cause Analysis:** Diagnostic tool to help determine the possible cause of service failure

## Modeling Services

You can create a new target, called a service, to model and monitor your business applications from within Grid Control. While creating a service, you can define the availability, performance and usage parameters, and service-level rules.

### Availability

"Availability" of a service is a measure of the end users' ability to access the service at a given point in time. However, the rules of what constitutes availability may differ from one application to another. For example, for a Customer Relationship Management (CRM) application, availability may mean that a user can successfully log on to the application and access a sales report. For an online store, availability may be monitored based on whether the user can successfully log in, browse the store, and make an online purchase.

Grid Control allows you to define the availability of your service based on service tests or systems.

- **Service Test-Based Availability:** Choose this option if the availability of your service is determined by the availability of a critical functionality to your end users. Examples of critical functions include accessing e-mail, generating a sales report, performing online banking transactions, and so on. While defining a service test, choose the protocol that most closely matches the critical functionality of your business process, and beacon locations that match the locations of your user communities. You can define one or more service tests using standard protocols and designate one or more service tests as "Key Tests." These key tests can be executed by one or more "Key Beacons" in different user communities. A service is considered available if one or all key tests can be executed successfully by at least one beacon, depending on your availability definition.
- **System-Based Availability:** Your service's availability can alternatively be based on the underlying system that hosts the service. Select the components that are critical to running your service and designate one or more components as "Key Components," which are used to determine the availability of the service. The service is considered available as long as at least one or all key components are up and running, depending on your availability definition. For more information on systems, refer to the "[Managing Systems](#)" section in this chapter.

## Performance and Usage

You can define metrics to measure the performance and usage of the service. Performance indicates the response time of the service as experienced by the end user. Usage metrics are based on the user demand or load on the system.

Performance metrics are collected for service tests when the service tests are run by beacons. You can calculate the minimum, maximum, and average response data collected by two or more beacons. For example, you can monitor the time required to retrieve e-mails from your e-mail service in San Francisco, Tokyo, and London, then compare results. You can also collect performance metrics for system components, then calculate the minimum, maximum, and average values across all components. For example, you can monitor average CPU utilization, memory utilization, and disk I/O utilization across several hosts.

Usage metrics are collected based on the usage of the system components on which the service is hosted. For example, if you are defining an e-mail service that depends on an IMAP server, you can use the Total Client Connections metric of the IMAP server to represent the usage of this e-mail service. You can monitor the usage of a specific component or statistically calculate the minimum, maximum, and average values from a set of components. You can also set thresholds on the above metrics and receive notifications and alerts. For more information on setting thresholds, see the "[Monitoring Services](#)" section of this chapter.

## Business Metrics

You can define metrics to measure the performance of business in an organization. Business metrics are collected for system based services. Non system based metrics can be defined by using the Data Exchange feature. For more details on the Data Exchange feature, refer to *Oracle Enterprise Manager Integration Guide*.

.You can define the business metric to be based on the performance of one specific system component or aggregate it across multiple components. You can also set thresholds on these metrics and receive notifications and alerts.

## Setting Service-Level Rules

Service-level parameters are used to measure the quality of the service. These parameters are usually based on actual service-level agreements or on operational objectives.

Grid Control's Service Level Management feature allows you to proactively monitor your enterprise against your service-level agreements to verify that you are meeting the availability, performance, and business needs within the service's business hours. For service-level agreements, you may want to specify the levels according to operational or contractual objectives.

By monitoring against service levels, you can ensure the quality and compliance of your business processes and applications.

## Monitoring Templates for Services

Administrators are often faced with the task of defining similar monitoring attributes or rules for many applications. The same set of rules are often applicable to different applications. This can be achieved through the Monitoring Templates feature in Grid Control. A monitoring template for a service contains definitions for one or more service tests, as well as a list of monitoring beacons. You can create a monitoring template from a standard service target, then copy this template to create service tests for any number of service targets and specify a list of monitoring beacons. This helps reduce the required configuration time where a large number of applications need to be monitored.

## Managing Systems

A **"system"** is a logical grouping of targets that collectively hosts one or more services. It is a set of infrastructure targets (hosts, databases, application servers, and so on) that function together to host one or more applications or services.

In Enterprise Manager, systems constitute a new target type. For example, to monitor an e-mail application in Enterprise Manager, you would first create a system, such as "Mail System," that consists of the database, listener, application server, and host targets on which the e-mail application runs. You would then create a service target to represent the e-mail application and specify that it runs on the Mail System target.

---

---

**Note:** An Enterprise Manager "System" is used specifically to monitor the components on which a service runs. Many of the functions and capabilities for groups and systems are similar.

---

---

## Creating Systems

Use the Create System pages to perform the following configuration tasks:

- Select target components for a new system.
- Define the associations between the components of the system using the Topology Viewer.
- Add charts that will appear in the System Charts page. The charts represent the overall performance for the system or components of the system. Based on the target type of the components you select in the Components page, some charts are predefined.



- Select a set of columns you want to appear in the System Components page and in the system's Oracle Grid Control Dashboard.
- Customize the refresh frequency and specify the format for viewing component status, alerts, and policy violations in the system's Oracle Grid Control Dashboard.

Enterprise Manager provides a Topology Viewer for several applications. The Topology Viewer allows you to view the relationships between components, nodes, or objects within different Oracle applications. You can zoom, pan, see selection details and summary information, and evaluate aggregate components. Individually distinct icons are used for each object type, and standardized visual indicators are used across all applications.

You may want to create system topologies for a number of reasons:

- Graphically model relationships
- Identify the source of a failure
- Perform visual analysis for high-level problem detection

When creating a system topology, you specify associations between the components in the system to logically represent the connections or interactions between them. For example, you can define an association between the database and the listener to indicate the relationship between them. Components are represented as icons, and associations are depicted as arrow links between components. After you have customized the topology to suit your needs, you can then view the overall status of the components in your system by accessing the System Topology page.

**See Also:** "Create System Topology Page" in the Enterprise Manager online help

## Monitoring Systems

Use the System pages to perform the following monitoring and administration tasks:

- Quickly view key information about components of a system, such as outstanding alerts and policy violations.
- View metric data for several time periods.
- View summary information determined by the columns you configured when you created the system.
- Perform administrative tasks, such as creating jobs and blackouts.
- View the topology of system components, including the associations between them.

**See Also:** ["System Topology"](#) in this chapter

Figure 8–1 System Home Page

**System: EM Website System**  
Page Refreshed Feb 24, 2010 10:58:24 PM GMT

**General**  
Owner: SYSMAN  
Problem Jobs: 0  
Last 7 days  
Privilege Propagation: Disabled

**Alerts**

Severity	Current	Last 24 hours
⊗	0	0
⚠	0	0
Total	0	0

**Services**

Name	Type	Status	Performance Alerts	Usage Alerts	Policy Violations
EM Website	Web Application	⬇	0 0	0 0	0 0 0

**Policy Violations**

Severity	Current	Last 24 Hours		Distinct Policies Violated
		Cleared	New	
⊗	32	1	1	4
⚠	2	0	0	1
ⓘ	0	0	0	0
Total	34	1	1	5

**Security Policy Violations**

Severity	Current	Last 24 Hours		Distinct Policies Violated
		Cleared	New	
⊗	32	1	1	4
⚠	2	0	0	1
ⓘ	0	0	0	0
Total	34	1	1	5

**Blackouts**

Status	Submitted to the Group	Submitted to any Member
Scheduled	0	0
Active	0	0

**Recommended Security Patches**  
Security Recommendations: None  
Job: RefreshFromMyOracleSupport  
⚠ Patch Recommendations information may be stale. My Oracle Support refresh job has not run successfully in 72 hours.

## Monitoring Services

Monitoring a service helps you ensure that your operational and service-level goals are met. To monitor a service, define service tests that simulate activity or functionality that is commonly accessed by end users of the service. For example, you may want to measure a service based on a particular protocol, such as DNS, LDAP, and IMAP. To proactively monitor the availability and responsiveness of your service from different user locations, designate the geographical locations from which these service tests will be executed. Run service tests from specified locations using Enterprise Manager Beacons. You may also measure a service based on the usage of the service’s system components.

## Services Dashboard

In Grid Control, service levels are defined as the percentage of time during business hours that a service meets the specified availability, performance, and business criteria. Using the Services Dashboard, administrators can determine whether the service levels are compliant with business expectations and goals.

The Services Dashboard enables administrators to browse through all service-level-related information from a central location. The Services Dashboard illustrates the availability status of each service, performance and usage data, as well

as service-level statistics. You can easily drill down to the root cause of the problem or determine the impact of a failed component on the service itself.

The following details are displayed in the Services Dashboard:

- **Availability:** A measure of the end users' ability to access the service at a given point in time. Service level agreements typically require a service be available at least for a minimum percentage of time.
- **Performance:** Response time is a good measure of the performance experienced by the end users when they access the service. When the service performance is poor, the availability of the service may be affected.
- **Usage:** Indicates end-user usage, or level of user activity, of the service.
- **Business:** Business metrics measure the performance of business in an organization. Business metrics are displayed only if one or more key business indicators are associated with the service. The Service Level is impacted when a critical alert is generated for the specified business metric.

**Figure 8–2 Consolidated Dashboard View of Multiple Services**

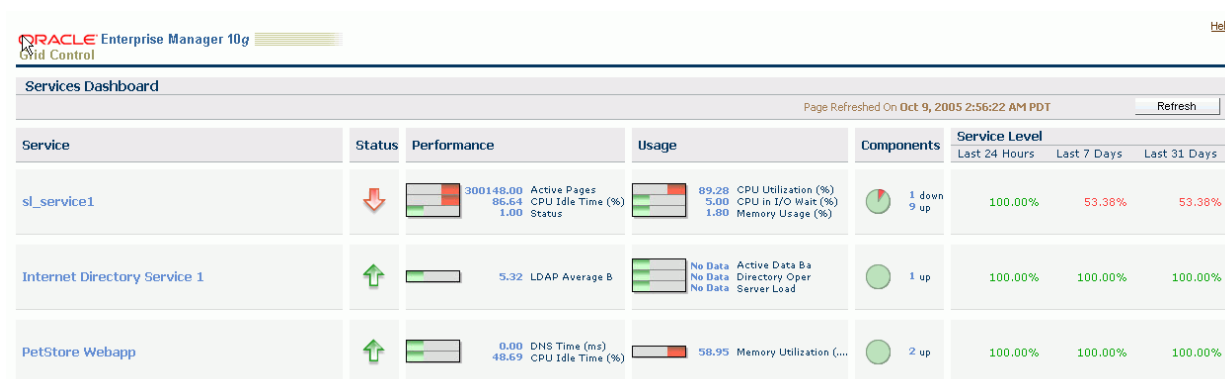

## System Topology

The System Topology page enables you to view the dependency relationships between components of the system. From the topology view, you can drill down to detail pages to get more information on the key components, alerts and policy violations, possible root causes and services impacted, and more.

Use the System Topology page, shown in [Figure 8–3](#), to get a quick overview of the status of your system's components. The status indicators over each icon enable you to quickly assess which components are down or have open alerts. You can get more detailed information for any key component from this page.

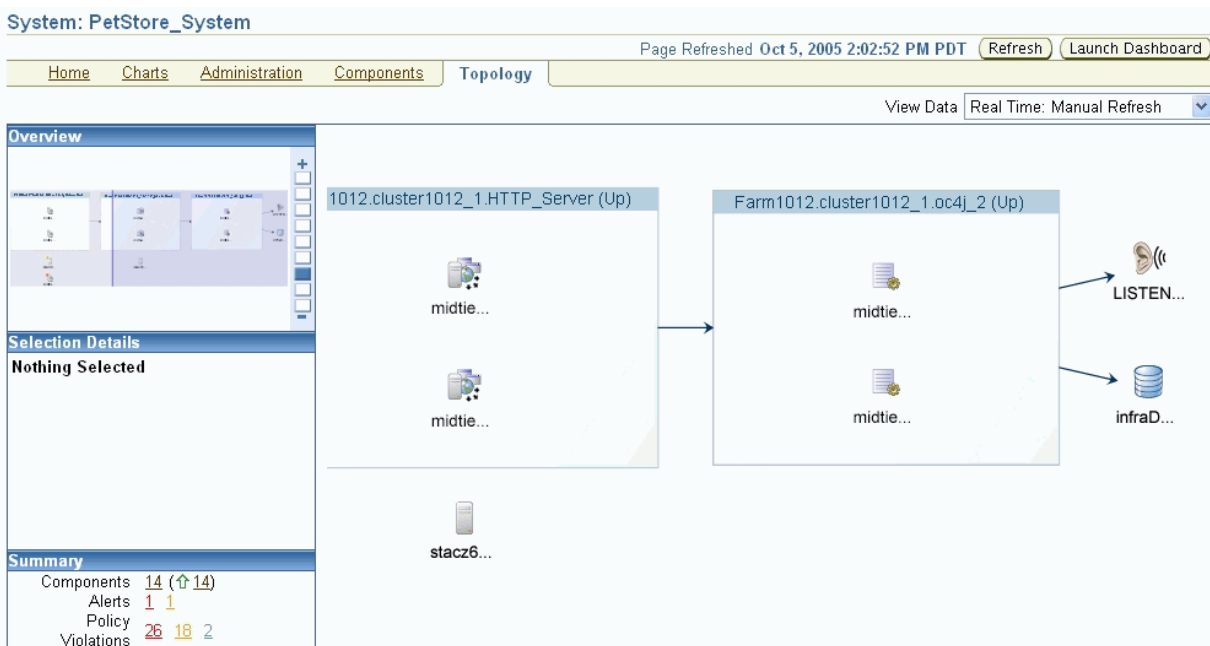
**Figure 8–3 System Topology Page**

**See Also:** ["Creating Systems"](#) in this chapter

## Service Topology

Use the Service Topology page, shown in [Figure 8–4](#), to view the dependencies between the service, its system components, and other services that define its availability. Upon service failure, the potential causes of failure, as identified by Root Cause Analysis, are highlighted in the topology view. In the topology, you can view dependent relationships between services and systems.

Some data centers have systems dedicated to one application or service, while others have shared systems that host multiple services. In Grid Control, you can associate a single service or multiple services with a system, based on the setup of the data center.

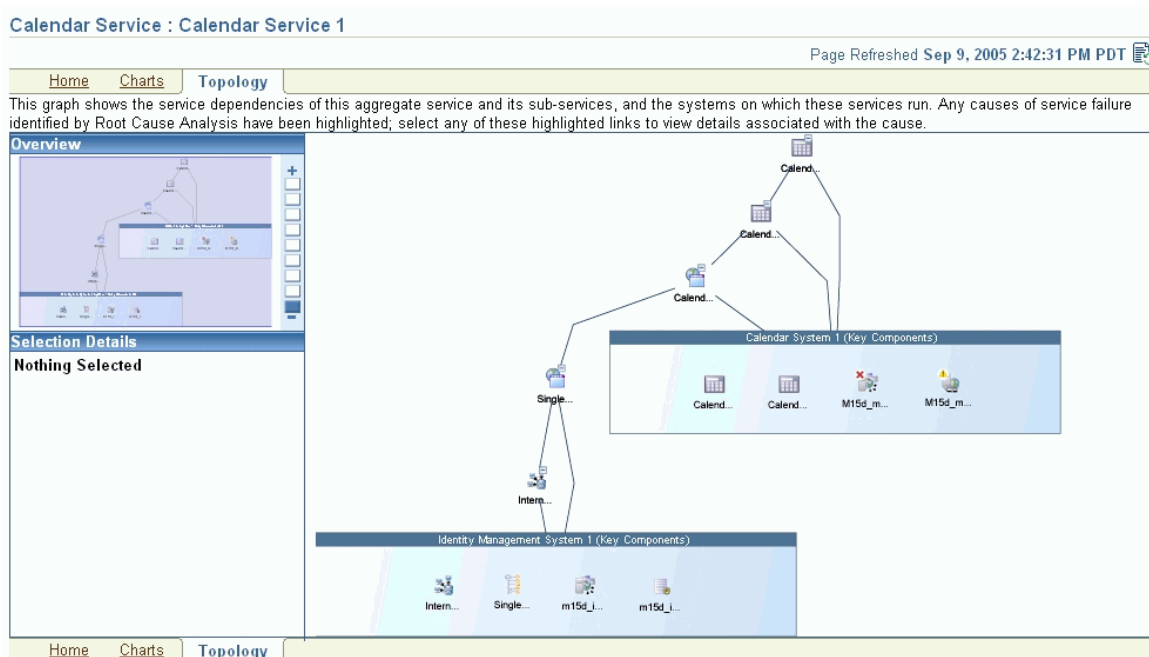
**Figure 8–4 Service Topology Page for a Collaboration Suite Service**

## Reports

Enterprise Manager provides out-of-box reports that are useful for monitoring services and Web applications. You can also set the publishing options for reports so that they are sent out via email at a specified period of time. Some of the reports that can be generated include Web Application Alerts, Web Application Transaction Performance Details, and Service Status Summary.

## Notifications, Alerts, and Baselines

Using Grid Control, you can proactively monitor a service and address problems before users are impacted. Each service definition has performance and usage metrics that have corresponding critical and warning thresholds. When a threshold is reached, Grid Control displays an alert. There are a standard set of notification rules that specify the alert conditions for which notifications should be sent to the appropriate administrators. Apart from these standard sets of rules, you can define and set up schedules so that administrators are notified when the specified alerts conditions are met. For example, thresholds can be defined so that alerts are generated when a system is down, if the end user cannot login to an application, or if the online transaction cannot be successfully completed.

You can set up baselines for a specified period and use these baselines to evaluate performance. Statistics are computed over the baseline period for specific target metrics. You can use these statistics to automatically set metric thresholds for alerting, as well as to normalize graphical displays of service performance.

## Service Performance

Grid Control provides a graphical representation of the historic and current performance and usage trends in the Performance and Usage Charts. You can view metric data for the current day (24 hours), 7 days, or 31 days. The thresholds for any performance or usage alerts generated during the selected period are also displayed in

the charts. This helps you to easily track the performance and usage of the service test or system over time and investigate causes of service failure. Users can choose the default chart for the Services Home page; all performance and usage charts are available on the Charts page.

Use the Test Performance page to view the historical and current performance of the service tests from each of the beacons. If a service test has been defined for this service, then the response time measurements as a result of executing that service test can be used as a basis for the service's performance metrics. It is possible to have multiple response time measurements if the service access involves multiple steps or the service provides multiple business functions. Alternatively, performance metrics from the underlying system components can also be used to measure performance of a service.

If performance of a service seems slow, it may be due to high usage of the service. Monitoring the service usage helps diagnose poor performance by indicating whether the service is affected by high usage of a system component.

## Monitoring Web Application Services

Today's e-businesses depend heavily upon their Web applications to allow critical business processes to be performed online. As more emphasis is placed on accessing information quickly, remotely, and accurately, how can you ensure your online customers can successfully complete a transaction? Are you certain that your sales force is able to access the information they need to be effective in the field?

The Web application management features complement the traditional target monitoring capabilities of Enterprise Manager. Full integration with the Enterprise Manager target monitoring capabilities allow you to monitor the performance and availability of components that make up the applications' technology environment, including the back-end database and the middle-tier application servers.

In Grid Control, you can define a Web application service to monitor Web transactions. This allows you to proactively monitor your e-business systems from the top down, and trace the experience of your end users as they enter and navigate the Web site. You can monitor the Web application service through the Services Dashboard, Topology Viewer, Charts, Reports, and more. For more information on these features, refer to the "[Monitoring Services](#)" section in this chapter.

Additionally, you can monitor the end-user performance response times, which enables you to effectively manage your e-business systems and understand the impact of application service-level problems.

### Transactions

Transactions are service tests that are used to test the Web application performance and availability. Important business activities for the Web application are recorded as transactions, which are used to test availability and performance of a Web application. A transaction is considered "available" if it can be successfully executed by at least one beacon. You can record the transaction using an intuitive playback recorder that automatically records a series of user actions and navigation paths.

### End-User Performance Monitoring

Oracle Real User Experience (RUEI) is a powerful Web-based utility which can be used to report on real-user traffic requested by, and generated from, your network. It measures the response times of pages and transactions at the most critical points in your network infrastructure. Powerful session diagnostics allow Application Managers and IT technical staff to perform root-cause analysis.

It enables you to view server and network times based on the real-user experience, monitor your Key Performance Indicators (KPIs) and Service Level Agreements (SLAs), and trigger alert notifications on incidents that violate their defined targets.

You can implement checks on page content, site errors, and the functional requirements of your transactions. Based on this information, you can verify your business and technical operations. You can set custom alerts on the availability, throughput, and traffic of everything identified in RUEI.

RUEI comes with a library of powerful reports that provide both business-orientated and technical-orientated users with the information they need to make effective decisions. In addition, authorized users can quickly create their own reports or modify existing reports. Using these reports, they can directly interact with the Web data to gain a deep understanding of online usage behavior, as well as the overall status of Web applications. They can view these reports interactively, or receive them by e-mail.

Using RUEI's dynamic drill-down capabilities, you can quickly focus on any desired level of Web results. You can sort, filter, and export information. In addition, you can correlate any data across a wide variety of criteria, including time, client location, transaction, and user name. The session diagnostics facility enables you to perform root-cause analysis of operational problems. It offers you the ability to assess any individual session, and review all the user's activity within that session. For more details, see *Oracle Real User Experience Insight User's Guide*.

## Monitoring Forms Applications

Oracle Forms provides a set of integrated builders that allow application developers to easily and quickly construct sophisticated database forms and business logic with minimal effort. The powerful, declarative features in Oracle Forms enable developers to create fully functional applications from database definitions with significantly reduced coding.

A Form is a collection of UI widgets that serves a specific purpose. It is usually built to perform one isolated task (such as accessing and displaying user data). A Forms application is a set of Forms that are related to each other. For example, Financials is a Forms application that contains Forms like, `DISPLAY_SALARY`, `EDIT_ACCOUNT`, and `PRINT_TAX_ACCOUNT`.

A Forms Application target in Enterprise Manager is used to model and monitor a specific Forms application. You can define, monitor, and playback a specific flow in the Forms application where each flow is recorded as a single Forms transaction. You can also measure the response time data as experienced by end-users while they are performing a Forms operation. You can measure the total response time, server time, and the database time for Forms operations such as Commit, Query, Runform, Callform, Newform, and Openform

### Forms Transactions

A Forms transaction consists of a set of user actions within a single application when using Forms. You can record multiple Forms transactions by using the intuitive playback recorder that automatically records the Forms actions. You can monitor these transactions periodically and collect relevant metrics when these transactions are played back.

### End-User Performance Monitoring

The End-User Performance Monitoring utility allows you to measure the response time of your applications by viewing information about how quickly the responses are. When configured with Oracle Application Server Web Cache or Oracle HTTP

Server/ Apache HTTP Server, the End-User Performance Monitoring feature provides response time data generated by actual end users as they access a Forms application and perform a set of Forms actions.

When you access a Forms application, the End-User Performance Monitoring utility measures the response time of Forms actions such as Commit, Query, Runform, Callform, Newform, and Openform. You can monitor the Forms actions and view reports based on the response times experienced by the user. You can also define a Watch List of the most important Forms actions to monitor and view the response metrics of these critical operations at a glance.

## Diagnosing Service Problems

Enterprise Manager Grid Control offers you tools to help diagnose service problems, including Root Cause Analysis, Topology Viewer, and Web application diagnostics. If a service is unavailable or performing poorly, use these tools to determine the potential causes.

### Root Cause Analysis

When a service fails, Root Cause Analysis returns a list of potential causes on the Service Home page. Potential root causes include failed subservices and failed key system components.

By default, Root Cause Analysis evaluates a key component's availability status to determine whether or not it is a cause of service failure. You can specify additional conditions, or component tests, for Root Cause Analysis to consider. If a key component is unavailable, or if any of your component test's conditions are not met, then this component is considered a possible cause of the service failure.

You can also specify additional conditions, or component host tests, for the host on which this key component resides. If Root Cause Analysis identifies the key component as a cause of service failure, the component's host is then analyzed to see if it potentially caused the component, and therefore the service, to fail.

You can also access the Root Cause Analysis information from the Topology Viewer, which shows a graphical representation of the hierarchical levels displaying relationships between components. Red lines between the services and system components represent the associated failure. Follow these red lines to discover possible causes of failure.

Enterprise Manager Grid Control can also be integrated with the EMC SMARTS solution to detect network failures in Root Cause Analysis. When problems in the network are detected, you can use the SMARTS network adapter to query Root Cause Analysis information related to the hosts and IP addresses in the network.



---

---

# Middleware Management

This chapter describes how you can use Enterprise Manager to manage middleware software including Oracle Fusion Middleware 11g, Oracle WebLogic Server, Oracle Application Server 10g, and non-Oracle middleware software such as IBM WebSphere, JBoss, and Microsoft.NET.

This chapter covers the following:

- [Introduction to Middleware Management](#)
- [Oracle Fusion Middleware Control versus Oracle Enterprise Manager Grid Control](#)
- [Using Oracle Enterprise Manager Grid Control to Manage the Oracle Fusion Middleware Environment](#)
- [Adding Middleware Targets to Oracle Enterprise Manager Grid Control](#)
- [Out-of-Box Monitoring of Middleware Targets](#)
- [Diagnosing Performance Problems](#)
- [Administering Middleware Targets](#)
- [Managing Configurations](#)
- [Managing Service Levels](#)
- [Automating Operations](#)

## Introduction to Middleware Management

Middleware is the software that connects software components or enterprise applications. Middleware is the software layer that lies between the operating system and the applications on each side of a distributed computer network. Typically, it supports complex, distributed business software applications.

Middleware is the infrastructure which facilitates creation of business applications, and provides core services like concurrency, transactions, threading, messaging, and the SCA framework for service-oriented architecture (SOA) applications. It also provides security and enables high availability functionality to your enterprise.

Middleware includes Web servers, application servers, content management systems, and similar tools that support application development and delivery. It is especially integral to information technology based on Extensible Markup Language (XML), Simple Object Access Protocol (SOAP), Web services, SOA, Web 2.0 infrastructure, and Lightweight Directory Access Protocol (LDAP), etc.

Managing these applications and the underlying middleware technology can be difficult and IT organizations often have to rely on a variety of specialized tools. This can lead to inefficiency and may introduce complexities and risks. Enterprise Manager Grid Control is a definitive tool for middleware management and allows you to manage both Oracle applications and custom Java EE applications that run on a combination of Oracle Middleware and non Oracle Middleware software.

This section introduces you to Enterprise Manager Grid Control which offers a unique management solution for Oracle and non Oracle middleware technologies.

## Using Oracle Enterprise Manager Grid Control to Manage the Oracle Fusion Middleware Environment

After you install and configure Oracle Fusion Middleware, you can use Oracle Enterprise Manager 11g Fusion Middleware Control to manage the Oracle Fusion Middleware environment. Fusion Middleware Control is a Web browser-based, graphical user interface that you can use to monitor and administer a farm with a single Oracle WebLogic Server domain.

A farm is a collection of components managed by Fusion Middleware Control. It can contain one Oracle WebLogic Server domain, one Administration Server, one or more Managed Servers, clusters, and the Oracle Fusion Middleware components that are installed, configured, and running in the domain.

Fusion Middleware Control organizes a wide variety of performance data and administrative functions into distinct, Web-based home pages for the farm, domain, servers, components, and applications. The Fusion Middleware Control home pages make it easy to locate the most important monitoring data and the most commonly used administrative functions—all from your Web browser.

However, you can manage only one Fusion Middleware farm with Fusion Middleware Control. Typically, an enterprise would have multiple farms. Managing several farms from different, distinct Fusion Middleware Control consoles becomes very difficult.

For centralized management and additional management functionality (such as historical data collections for performance trending, email and page notifications for potential availability and/or performance problems, and service level management), you can use Enterprise Manager Grid Control.

## Oracle Fusion Middleware Control versus Oracle Enterprise Manager Grid Control

You can manage your Oracle Fusion Middleware environment using Oracle Enterprise Manager Fusion Middleware Control (Fusion Middleware Control) or Oracle Enterprise Manager Grid Control.

### Managing Oracle Fusion Middleware with Fusion Middleware Control

Fusion Middleware Control organizes a wide variety of performance data and administrative functions into distinct, Web-based home pages for the farm, cluster, domain, servers, components, and applications. The Fusion Middleware Control home pages make it easy to locate the most important monitoring data and the most commonly used administrative functions all from your Web browser.

Fusion Middleware Control is a part of the Oracle Fusion Middleware 11g installation. With Fusion Middleware Control, you can:

- Manage a single Oracle Fusion Middleware Farm and a single WebLogic Domain.
- Monitor the availability and performance of Fusion Middleware software in real time mode.
- Perform routine administration tasks such as deploying applications, configuring parameters etc.

For more details, see the *Oracle Fusion Middleware 11g Administrator's Guide*.

## Managing Oracle Fusion Middleware with Oracle Enterprise Manager 11g Grid Control

Oracle Enterprise Manager 11g Grid Control is a Web browser-based, graphical user interface that you can use to monitor multiple Oracle Fusion Middleware Farms and Oracle WebLogic Server Domains. In fact, Grid Control provides deep management solutions for Oracle technologies including Oracle packaged applications, Oracle Database and Oracle VM. Grid Control also offers extensive support for non-Oracle technologies through more than two dozen heterogeneous management plug-ins and connectors including Microsoft MOM, IBM WebSphere, JBoss, EMC storage, F5 BIG IP, Check Point Firewall, and Remedy.

Oracle Enterprise Manager 11g Grid Control needs to be installed separately as it is not a part of the Oracle Fusion Middleware 11g installation. With Oracle Enterprise Manager 11g Grid Control, you can:

- Centrally manage multiple Oracle Fusion Middleware Farms and WebLogic Domains.
- Manage third party tools such as WebSphere, JBoss, Tomcat, and Microsoft.NET Framework.
- Manage non-middleware software such as underlying operating systems and hardware on which the middleware software is installed. This allows administrators to correlate middleware performance with its underlying host performance.
- Manage database software and diagnose application performance problems and identify the true root cause of the problem and the tier (middleware, database) on which it occurs.
- Monitor the availability and performance of Oracle Fusion Middleware software in real time and from a historical perspective for trend analysis.
- Diagnose availability and performance problems.
- Monitor and trace important end-user requests from the client to the service endpoint across all the servers and applications associated with each transaction.
- Use Application Dependency and Performance (ADP) to analyze J2EE and SOA applications.
- Monitor Java applications and diagnose performance problems in production using JVM Diagnostics.
- Define Service Level Objectives (SLOs) in terms of out-of-box system-level metrics as well as end user experience metrics to accurately monitor and report on Service Level Agreement (SLA) compliance.
- Perform several critical tasks like:
  - Setting thresholds on performance metrics. When these thresholds are violated, email and page notifications are sent.

- Tracking configuration changes and compare configurations between example test environment and production environment.

## Adding Middleware Targets to Oracle Enterprise Manager Grid Control

To add middleware related targets (e.g. Oracle Fusion Middleware 11g, Oracle WebLogic Domain, Oracle Application Server 10g, JBoss Application Server) to Enterprise Manager Grid Control, follow these steps:

1. After you have logged in, click **Targets > Middleware**. The following page is displayed:

**Figure 9-1 Middleware Page**

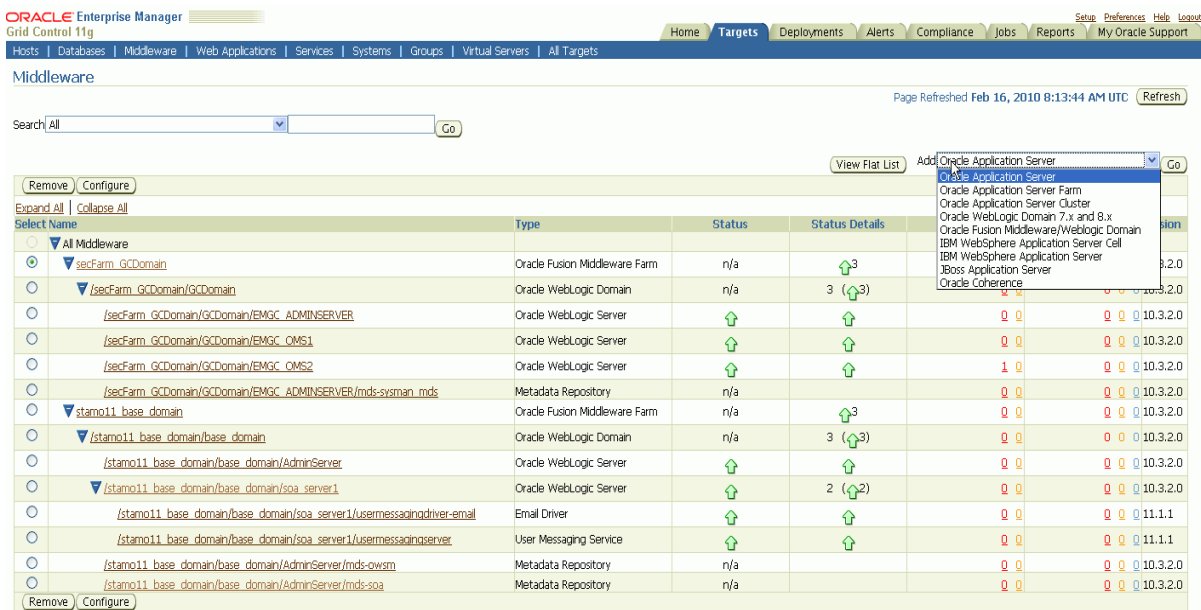

2. Select a middleware target from the Add drop-down list. The Add wizard is displayed which guides through the process of adding the target.
3. Click **OK** when you have finished. The selected target will be added and displayed on the Middleware page.

After you have added the target, you can view general information about the targets including their status and availability on the Middleware page. You can drill down into each target to get further details like how the target is performing, where it is deployed, the version, location of its home directory, and so on.

You can also view the number of critical, warning, and error alerts generated for the past 24 hours. These alerts indicate that a particular metric condition has been encountered. For example, an alert is triggered when a metric threshold is reached. Using these details, you can drill down to investigate the target and the problem that triggered the alert.

You can monitor the following components using Oracle Enterprise Manager Grid Control:

- Oracle Fusion Middleware Components
- Oracle Application Server Components

- Non-Oracle Middleware Components

## Oracle Fusion Middleware Components

You can monitor the following Oracle Fusion Middleware components using Enterprise Manager Grid Control:

- **Oracle WebLogic Server Domains, Clusters, and Managed Servers:** A WebLogic Server domain is a logically related group of WebLogic Server resources that you manage as a unit. A domain includes one or more WebLogic Servers and may also include WebLogic Server clusters. Clusters are groups of WebLogic Servers instances that work together to provide scalability and high-availability for applications. With Oracle Enterprise Manager Grid Control, you can monitor and manage the farm, domains, clusters, servers, and deployed applications.
- **Oracle SOA Suite:** The Oracle SOA Suite enables services to be created, managed, and orchestrated into SOA composite applications. Composite applications enable you to easily assemble multiple technology components into one SOA composite application. Oracle SOA Suite plugs into heterogeneous infrastructures and enables enterprises to incrementally adopt SOA. You can:
  - Automatically discover and model SOA components such as BPEL Process Manager, Oracle Service Bus, Service Engines etc.
  - Monitor the health and performance of the SOA components.
  - Trace the flow of an instance across all SOA Infrastructure applications.
  - Create systems, services, and aggregate services.
- **Oracle WebCenter:** The Oracle WebCenter is an integrated set of components with which you can create social applications, enterprise portals, collaborative communities, and composite applications, built on a standards-based, service-oriented architecture. It combines dynamic user interface technologies with which to develop rich internet applications, the flexibility and power of an integrated, multichannel portal framework, and a set of horizontal Enterprise 2.0 capabilities delivered as services that provide content, collaboration, presence, and social networking capabilities. Based on these components, Oracle WebCenter also provides an out-of-the-box, enterprise-ready customizable application, WebCenter Spaces, with a configurable work environment that enables individuals and groups to work and collaborate more effectively.
- **Oracle WebTier:** This consists of:
  - **Oracle HTTP Server:** Oracle HTTP Server (OHS) is the underlying deployment platform for all programming languages and technologies that Oracle Fusion Middleware supports. It provides a Web listener and the framework for hosting static and dynamic pages and applications over the Web. Based on the proven technology of the Apache 2.2.10 infrastructure, OHS includes significant enhancements that facilitate load balancing, administration, and configuration. It also includes a number of enhanced modules, or mods, which are extensions to the HTTP server that extend its functionality for other enterprise applications and services. You can:
    - \* Automatically discover and monitor Oracle HTTP Servers running within the application servers.
    - \* View a list of metrics to gauge the server performance and virtual host performance.
    - \* View the top URLs being accessed.

- \* Perform the enterprise configuration management tasks like viewing, comparing, and searching configuration information.
- **Oracle Web Cache:** Oracle Web Cache is a content-aware server accelerator, or reverse proxy, for the Web tier that improves the performance, scalability, and availability of Web sites that run on any Web server or application server, such as Oracle HTTP Server and Oracle WebLogic Server. Oracle Web Cache is the primary caching mechanism provided with Oracle Fusion Middleware. Caching improves the performance, scalability, and availability of Web sites that run on Oracle Fusion Middleware by storing frequently accessed URLs in memory. You can:
  - \* Automatically discover and monitor OracleAS Web Cache instances running within application servers.
  - \* View the metrics associated with this target to analyze their performance.
  - \* Perform enterprise configuration tasks like viewing, comparing, and searching configuration information.
- **Oracle Identity Management:** This is an enterprise identity management system that automatically manages users' access privileges within the resources of an enterprise. It provides a shared infrastructure for all Oracle applications. It also provides services and interfaces that facilitate third-party enterprise application development. These interfaces are useful for application developers who need to incorporate identity management into their applications.
- **Oracle Portal:** This is a Web-based tool for building and deploying e-business portals. It provides a secure, manageable environment for accessing and interacting with enterprise software services and information resources. A portal page makes data from multiple sources accessible from a single location.
- **Oracle Forms Services** is a middle-tier application framework for deploying complex, transactional forms applications to a network such as an intranet or the Internet. With Oracle Forms Services, business application developers can quickly build comprehensive Java client applications that are optimized for the Internet without writing any Java code, and that meet (and exceed) the requirements of professional user communities. These Java client applications are Web-deployed applications available on demand for rapid processing of large amounts of data and rapid completion of complex calculations, analysis, and transactions.
- **Oracle Coherence** is a component of Oracle Fusion Middleware that enables organizations to predictably scale mission-critical applications by providing fast and reliable access to frequently used data. By automatically and dynamically partitioning data in memory across multiple servers, Oracle Coherence enables continuous data availability and transactional integrity, even in the event of a server failure. As a shared infrastructure, Oracle Coherence combines data locality with local processing power to perform real-time data analysis, in-memory grid computations, and parallel transaction and event processing. Oracle Coherence comes in three editions. You can:
  - Discover and manage a Coherence cluster and its various entities.
  - Monitor and configure various components such as nodes, caches, services, connections, and connection manager instances of a Coherence cluster.
  - Deploy and install a Coherence node based on the Provisioning Advisory framework.
- **Oracle Business Intelligence** is a complete, integrated solution that addresses business intelligence requirements. Oracle Business Intelligence includes Oracle

Business Intelligence Reporting and Publishing, Oracle Business Intelligence Discoverer, and Oracle Business Intelligence Publisher. You can:

- Manually discover Oracle BI Suite EE targets, and monitor their overall health.
- Diagnose, notify, and correct performance and availability problems in Oracle BI Suite EE targets.
- Access current and historical performance information using graphs and reports.
- Perform enterprise configuration management tasks like viewing, comparing, and searching configuration information.

## Oracle Application Server Components

You can monitor Oracle Application Server 10g components like Oracle Application Server Farms, Oracle Application Server Clusters, Oracle Application Servers, OC4J, Oracle HTTP Servers, Oracle Web Cache, Oracle Portal, Oracle Wireless, Oracle Forms Services, Oracle Reports Services, Oracle Business Intelligence, and Oracle Identity Management.

## Non-Oracle Middleware Components

In addition to monitoring Oracle middleware components, Enterprise Manager Grid Control can also be used to monitor non-Oracle middleware software. The third-party middleware software that can be monitored includes the following:

- WebSphere Application Server
- WebSphere MQ
- JBoss Application Server
- Apache Tomcat
- Apache HTTP Server
- Microsoft Exchange Server
- Microsoft Internet Information Services
- Microsoft Active Directory
- Microsoft Commerce Server
- Microsoft BizTalk Server
- Microsoft Internet Security and Acceleration
- Microsoft .NET Framework

## Out-of-Box Monitoring of Middleware Targets

Enterprise Manager Grid Control organizes a wide variety of performance data and administrative functions into distinct, Web-based home pages for the farm, domain, servers, components, and applications.

### Target Home Page

Enterprise Manager Grid Control provides centralized monitoring across domains, configuration management, provisioning, real time and historical performance

analysis. You need to drill down to Oracle Fusion Middleware Control to perform administrative tasks and manage components in your farm.

The Home pages make it easy to locate the most important monitoring data and the most commonly used administrative functions—all from your Web browser.

When you login into Enterprise Manager Grid Control and select a Middleware target, the Home page for the target is displayed. For example, when you click on a WebLogic Server target in the Middleware page, the following screen is displayed.

**Figure 9–2 WebLogic Server Home Page**

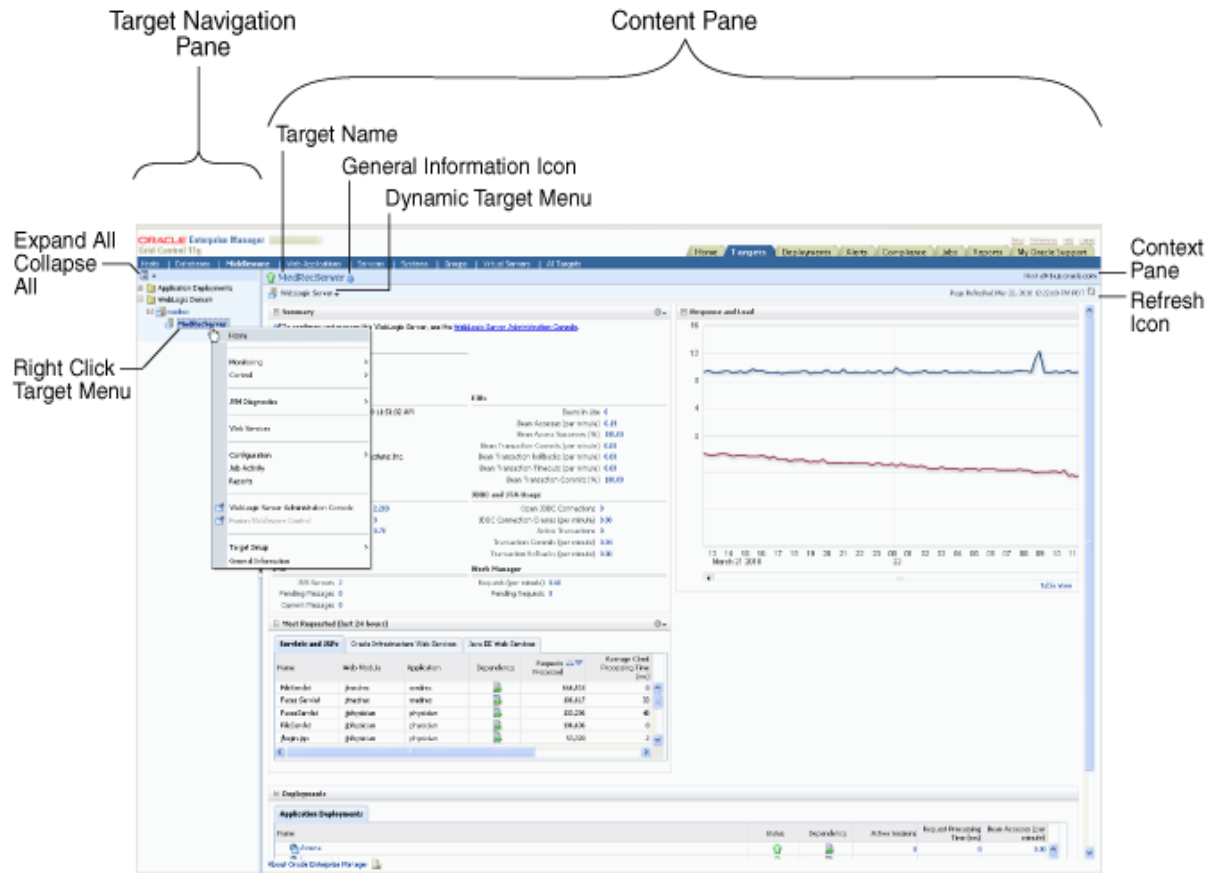

This figure shows the target navigation pane on the left and the content page on the right. From the target navigation pane, you can expand the tree and select a component or an application.

When you select a target, the target's home page is displayed in the content pane and that target's menu is displayed at the top of the page, in the context pane. You can also view the menu for a target by right-clicking the target in the navigation pane.

In the preceding figure, the following items are called out:

- **Target Navigation Pane** lists all of the targets in a navigation tree
- **Content Pane** shows the current page for the target. When you first select a target, that target's home page is displayed.
- **Dynamic Target Menu** provides a list of operations that you can perform on the currently selected target. The menu that is displayed depends on the target you



select. The menu for a specific target contains the same operations as those in the Right-Click Target Menu.

- **Right-Click Target Menu** provides a list of operations that you can perform on the currently selected target. The menu is displayed when you right-click the target name in the target navigation pane. In the figure, even though the WebLogic Server is selected and its home page is displayed, the right-click target menu displays the operations for the MedRecServer because the user has right-clicked the MedRecServer.
- **Target Name** is the name of the currently selected target.
- **Context Pane** provides the host name, the time of the last page refresh, and the Refresh icon.
- **Expand All / Collapse All** lets you expand or collapse the navigation tree.
- **Refresh** icon indicates when the page is being refreshed. Click it to refresh a page with new data. (Refreshing the browser window refreshes the page but does not retrieve new data.)

From the Home page, you can also access the Fusion Middleware Control and WebLogic Server Administration Console by clicking on the appropriate link or selecting the appropriate menu item on the page.

## Out-of-box Metrics

Enterprise Manager Grid Control provides a set of pre-defined performance metrics for each middleware target. These metrics are available for domains, cluster, server, applications, web services, resources etc. The metric data is collected and stored in the Management Repository. For more details on the pre-defined metrics, see the *Oracle Fusion Middleware Metric Reference Guide*.

For example, Enterprise Manager Grid Control can automatically monitor:

- The CPU or memory consumption of the application server, including detailed monitoring of individual Java Virtual Machines (JVMs) being run by Oracle WebLogic servers.
- Java EE application responsiveness from the application down through individual servlets and Enterprise JavaBeans (EJBs)
- Oracle HTTP Server session volumes, connection duration, and error rates
- Oracle Web Cache hit rates and volumes
- Top servlets based on number of requests, maximum processing time, and highest average processing time

The performance metrics provide details about the metric as a current real time value (30 seconds, 1 minute, or 5 minutes) or a previous value (past 24 hours, 7 days, or 31 days). The historical information is displayed as graphs and a table. By using graphs, you can easily watch for trends, and by using tables, you can examine details of past metric severity history. The out-of-metrics can be viewed from the performance summary pages as shown below:

**Figure 9–3 Performance Summary Page**

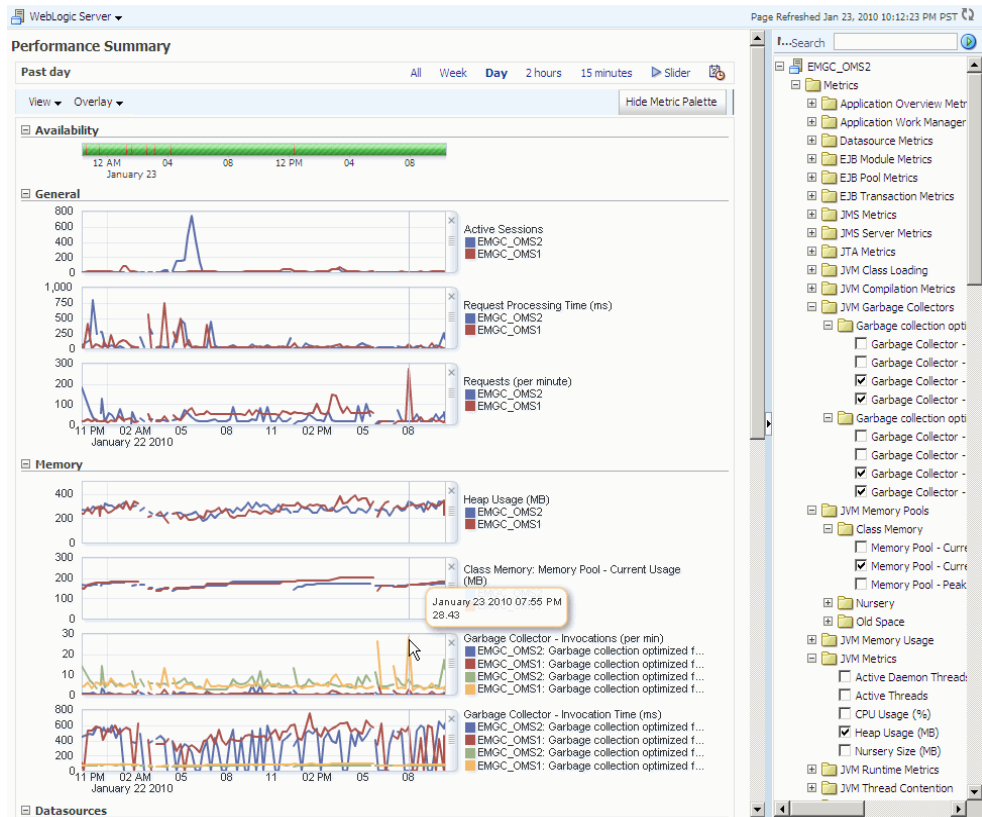

You can customize the charts by rearranging the order of the charts, removing a chart from the page, modify the scale of a chart, display the metrics in a hierarchical tree format, etc.

## Analyzing Historical Performance

Enterprise Manager Grid Control allows you to analyze historic metric data and perform trend analysis. You cannot view or analyze historical performance in Fusion Middleware Control. The metrics are collected and stored in the Management Repository, so you can analyze the data well after the situation has changed. For example, you can use historical data and diagnostic reports to research an application performance problem that occurred days or even weeks ago.

You can even provide a customized time period for which the data should be retrieved from the Management Repository. You can customize the time period for:

- Pre-defined range of the last 24 hours, last 7 days, or last 31 days
- Customized range of any number of days, weeks, months, or years
- Any start date and end date (such that the duration is not greater than 99 years)

---

**Note:** You can analyze historical metric data with Enterprise Manager Grid Control only. You cannot use Fusion Middleware Control to analyze historic performance.

---

## Setting Metric Thresholds for Alert Notifications

Metric snapshots are named snapshots of a target's past performance. You can use metric snapshots to calculate thresholds based on deviations from this past performance. Thresholds are boundary values against which monitored metric values are compared. You can specify a threshold such that, when a monitored metric value crosses that threshold, an alert is generated. You can get critical alerts when a monitored metric has crossed its critical threshold or warning alerts when a monitored metric has crossed its warning threshold.

Enterprise Manager Grid Control provides a comprehensive set of features that facilitates automated monitoring and generation of alerts. You can gather and evaluate diagnostic information for targets distributed across the enterprise, and an extensive array of middleware performance metrics are automatically monitored against predefined thresholds. By selecting a metric, you can determine whether the thresholds have been defined for a particular metric. These thresholds are used as a mechanism to generate alerts. These alerts in turn are used to notify you whether a target is up or down, the response time is slow, and so on. Thus, you can monitor their overall performance.

You can set up corrective actions to automatically resolve an alert condition. These corrective actions ensure that routine responses to alerts are automatically executed, thereby saving you time and ensuring that problems are dealt with before they noticeably impact the users.

## Monitoring Templates

You can also use monitoring templates to simplify the task of standardizing monitoring settings across your enterprise. You can specify the monitoring settings once and apply them to all Oracle Fusion Middleware targets. A Monitoring template defines all the parameters you would normally set to monitor Middleware target, such as:

- Target type to which the template applies
- Metrics (including user-defined metrics), thresholds, metric collection schedules, and corrective actions

When a change is made to a template, you can reapply the template across the affected targets in order to propagate the new changes. You can reapply monitoring templates as often as needed.

## Managing and Creating Blackouts

Enterprise Manager Grid Control comes with a bundle of performance and health metrics that enable automated monitoring of application targets in your environment. When a metric reaches the predefined warning or critical threshold, an alert is generated and the administrator is notified.

However, there are occasions when you want to perform maintenance work on your middleware targets, and not want any alerts to be generated while you are bringing them down. In this case, you can schedule a blackout and suspend monitoring of the middleware targets.

Blackouts allow you to suspend any data collection activity on one or more monitored targets, thus allowing you to perform scheduled maintenance on targets. If you continue monitoring during these periods, the collected data will show trends and other monitoring information that are not the result of normal day-to-day operations. To get a more accurate, long-term picture of a target's performance, you can use

blackouts to exclude these special-case situations from data analysis. Enterprise Manager Grid Control allows you to define new blackouts; view the status of existing blackouts; and edit, stop, and delete blackouts that are not required.

## Extend Monitoring for Applications Deployed to WebLogic Server

Many administrators often require custom logic to be written to check for conditions specific to their application environments. Enterprise Manager Grid Control allows integration of application instrumentation in Enterprise Manager Grid Control's event monitoring infrastructure. If application developers expose application instrumentation using standards like JMX or Web Services operations, then you can build management plug-ins for the instrumentation using easy-to-use command line tools, and leverage Enterprise Manager Grid Control's event monitoring system to monitor it. You do not have to edit any XML files or write any integration code to integrate such instrumentation. Follow these procedures to integrate application-defined instrumentation:

- Use Command Line Interfaces that analyze MBean interfaces for JMX and WSDL for Web Services and create management plug-ins
- Import Management Plug-in Archive in Enterprise Manager Grid Control
- Deploy Management Plug-in to Management Agents
- Create Target-type instances for the target types defined in Management Plug-in Archive
- Leverage Enterprise Manager Grid Control's event monitoring system including monitoring templates, corrective actions, historical and real time metric views, alerts, customization of notification rules, and methods on events generated from application instrumentation metrics.

Beginning with Enterprise Manager Grid Control release 11.1, administrators are able to add performance metrics beyond those available out-of-box for JMX-instrumented applications deployed on Oracle WebLogic Server. Administrators can additionally monitor JMX-enabled applications by defining new target type that can be monitored via management plug-ins, and then use a command line tool `emjmxcli` to automate the generation of the target metadata and collection files.

All JMX-enabled applications deployed to the WebLogic Server can be consolidated and monitored by a single management tool, Enterprise Manager Grid Control.

## Request Monitoring

Request Monitoring provides end-to-end visibility into requests and helps localize end-user performance problems based on the deployment model. You can monitor, understand, and visualize how servers interact with each other to deliver business end-user services requests. You can trace important end-user requests from the client to the service endpoint across all the servers and applications associated with each transaction. The trace data is used to model the call-path for these requests where call-paths represent the inter-server relationship and performance metrics for these requests. You can only monitor synchronous transactions running on WebLogic servers. With Request Monitoring, you can:

- Trace end-user transactions and capture the complete call-path of important requests.
- Reduce problem localization by diagnosing poorly performing requests and identifying the servers whose behavior (service time) deviates most from the norm.

- Reduce fault discovery time and set performance level objectives on request response times.
- Reduce fault-reason identification time by allowing the user to launch into Oracle Enterprise Manager JVM Diagnostics feature. This allows performance diagnostics to be done within the context of the problem experienced as well as historical statistics of the system when it was behaving normally.

### Defining and Managing Transactions Being Monitored

A request is a server entry-point that can be invoked by a Web Browser or an application. A group of request instances related to each other by some common attributes is known as a request. A collection of requests is known as a transaction group. A transaction can belong to one or more transaction groups. Violations occur when the critical and warning thresholds are exceeded. The administrator can mark one or more important requests as key requests. Alerts are generated for key requests only.

You can define requests that need to be monitored and tracked and group them for reporting purposes. A set of pre-defined requests and request groups are provided by default. You can create a new request, edit or delete an existing transaction. To define a request:

1. Log into Oracle Enterprise Manager and click the **Middleware** tab.
2. All the Middleware targets are displayed. Under the Related Links, click **Request Monitoring**.
3. Click **Request Performance** to view the performance of the request during a specific time period.

Figure 9-4 Request Performance Page

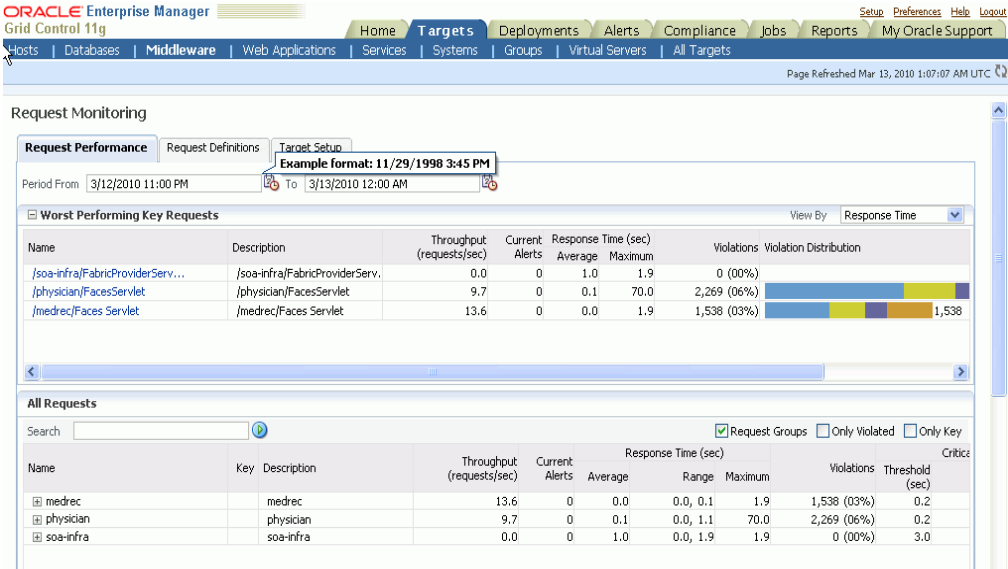

4. Click on a request to drill down to the Performance tab. The performance charts show the volume of requests over a time period and the average response time of all requests during this period. Two performance charts are displayed for the current and the comparison period. The charts provide a historic response time analysis of the request over the selected period of time.

5. Click on the Topology tab. The following screen is displayed.

**Figure 9–5 Topology Page**

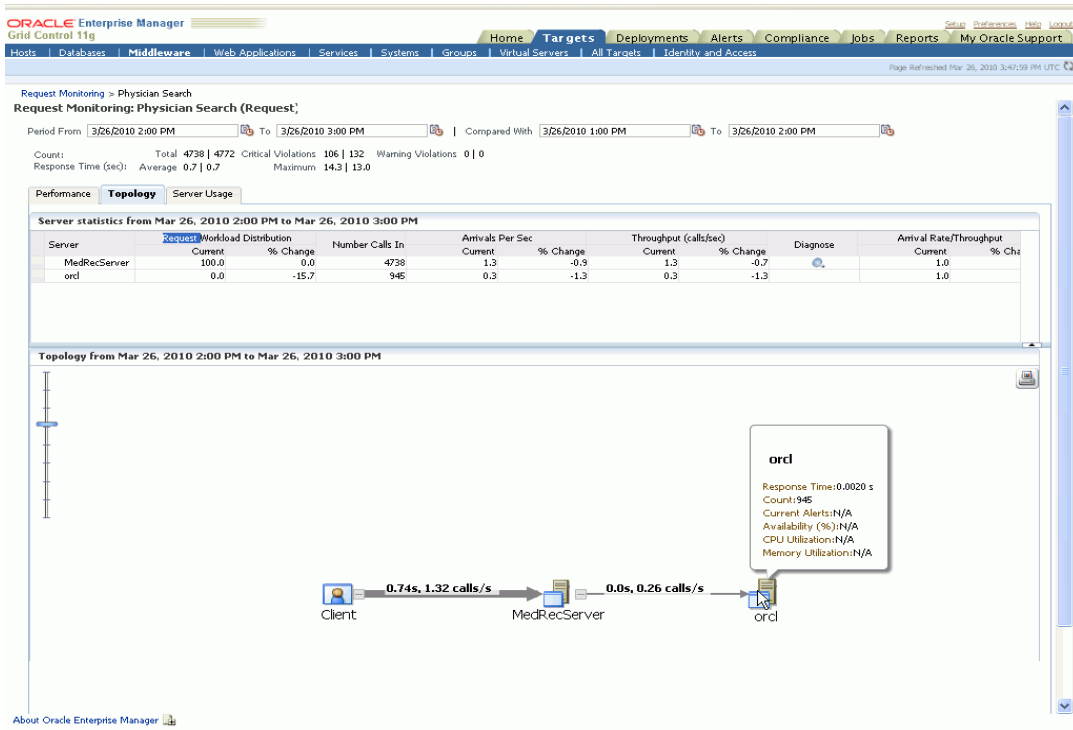

The topology chart shows the aggregate server level call paths of the request. The chart shows the calls made between the clients and the clusters or servers. Click on the icon on a cluster to view all the servers that are part of the cluster. Place the cursor on a cluster or server to view the following details:

- **Response Time:** The average response time taken by the server to process all the calls for the selected period.
  - **Count:** The total number of calls that have been made to the server.
  - **Current Alerts:** These alerts show the status of the server or cluster and indicate whether it is up or down, blacked out, or unreachable.
6. Click on the Server Usage tab. The following screen is displayed.

Figure 9–6 Server Usage Page



These charts show the workload distribution for the selected request in each server. The charts display the average of the percentage contribution of each server or cluster in the selected time period. You can see the workload distribution for good requests, requests that have violated the warning thresholds, and requests that have violated the critical thresholds.

## Diagnosing Performance Problems

This section describes the methods and tools used to diagnose performance problems. You can:

- View the list of most active Servlets and JSPs and identify the ones that are causing the bottleneck.
- Analyze Java EE and SOA applications using Application Dependency and Performance.
- Use Java Diagnostics to diagnose performance problems in production.

## Using Home Pages to Diagnose Performance Issues

When you are troubleshooting performance problems, it can be helpful to know which servlets or JSPs are the most active. By viewing the Most Requested section on the WebLogic Server Home page, you can identify the most active Java servlets, JSPs, Web Services, or Java EE Services running on the WebLogic Server instance.

When you receive an alert notification, Enterprise Manager Grid Control makes it easy for you to investigate the problem and take corrective actions wherever required. For example, notification of excessive CPU consumption by WebLogic Server may lead to investigation of the applications running on that instance. By using the Servlets and

JSPs tab in the Most Requested section of the WebLogic Server Home page, you can quickly identify the highest volume or least responsive application. You can then drill down and diagnose application's servlets, Java Server Pages (JSPs), or EJBs to identify the bottleneck.

**Figure 9-7 WebLogic Server Home Page (Most Requested)**

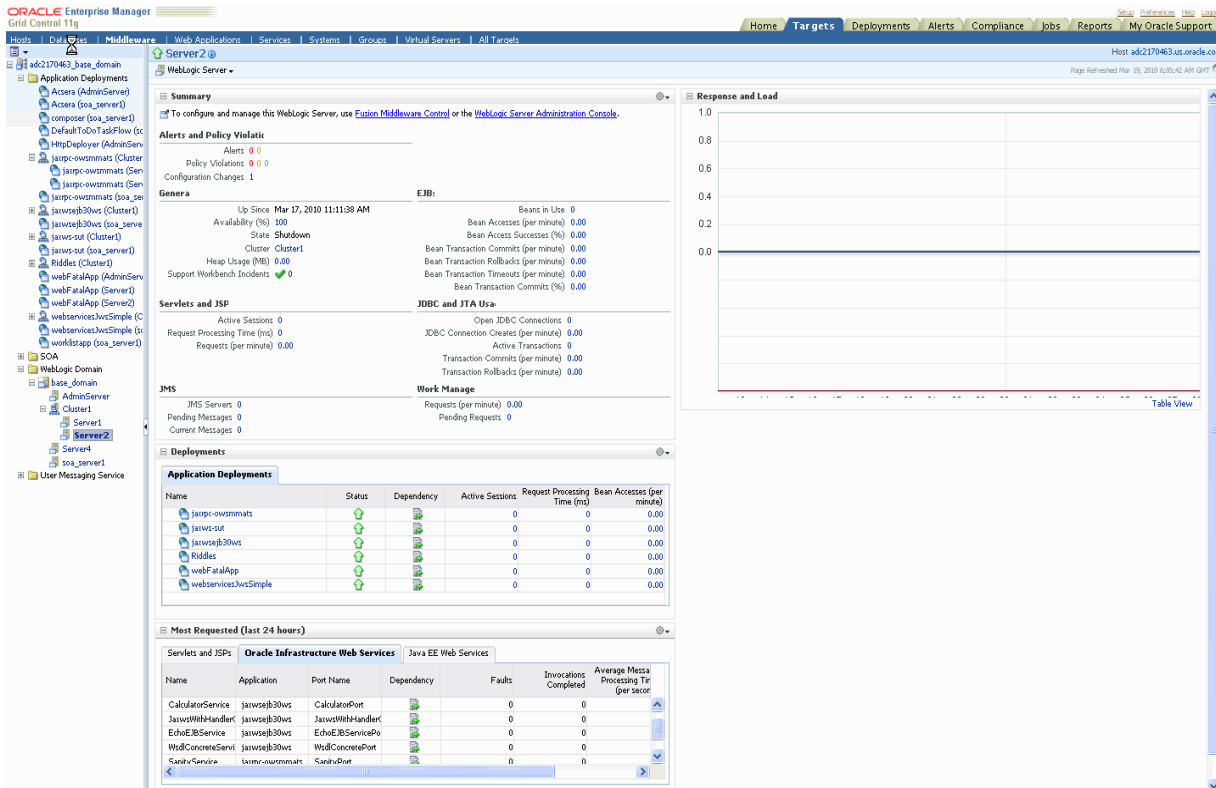

## Using Application Dependency and Performance to Monitor Middleware Targets

Application Dependency and Performance (ADP) analyzes Java EE and SOA applications and captures relationships among various application building blocks in its AppSchema model. ADP is able to deliver an ASM solution that self-customizes out-of-the-box, evolves with change, minimizes expert involvement, and delivers a holistic, service-oriented view across heterogeneous environments. This enables the enterprise to more efficiently manage distributed applications, attain management agility, and lower total cost of ownership.

For example, when ADP is pointed to a Oracle WebLogic domain, IBM WebSphere cell, or an Oracle SOA Suite cluster, it automatically discovers information about this particular domain including all deployed applications, configuration, resources, and others. ADP displays this information in the Monitoring tab under Oracle Enterprise Manager.

### Using Application Dependency and Performance

To use the Application Dependency and Performance feature available in Grid Control, follow these steps:

1. Log into Enterprise Manager.



2. From the Grid Control home page, click the Targets tab, then click the Middleware tab.
3. In the Related Links section located at the bottom of the page, select Application Dependency and Performance.
4. The Monitoring, Configuration, and Registration tabs display.

For additional information, refer to the *Getting Started with SOA Management Pack Plus* manual.

## Using Java Diagnostics to Identify and Troubleshoot Performance Issues

JVM Diagnostics enables administrators to monitor Java applications and diagnose performance problems in production. By eliminating the need to reproduce problems, it reduces the time required to resolve these problems. This improves application availability and performance. Administrators will be able identify the root cause of performance problems in the production environment without having to reproduce them in the test or development environment.

JVM Diagnostics provides real-time JVM visibility and historical diagnosis. JVM Pooling and Tracing are other features that allow to analyze heaps and diagnose performance problems. The key features are:

- Low overhead monitoring with deep diagnostics
- Easy Installation and Deployment
- Real-time JVM Visibility
- Cross-Tier Transaction Tracing
- Heap Analysis
- JVM Pooling
- Real-time and Historical Diagnosis
- JVM Tracing

### Using Java Diagnostics in Oracle Enterprise Manager

To use the Java Diagnostics feature, follow these steps:

1. Log into Oracle Enterprise Manager and click the Middleware tab.
2. All the Middleware targets are displayed. Click on a WebLogic Server target from the list.
3. The WebLogic Server Home Page is displayed. Select **JVM Diagnostics** from the drop-down list and select **Summary**. The JVM Diagnostics Summary page is displayed. You can view the java diagnostics details for the selected period.

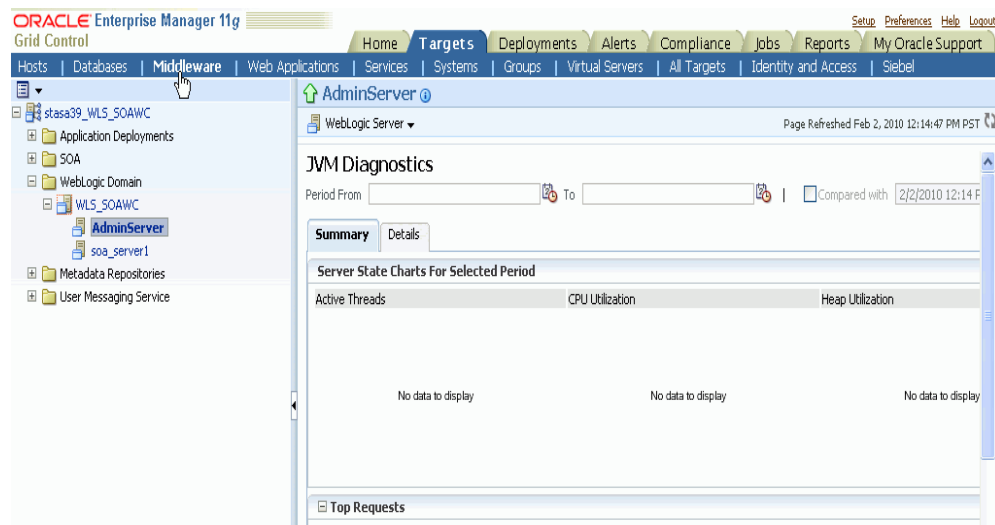
**Figure 9–8 JVM Diagnostics Summary Page**

## Administering Middleware Targets

Enterprise Manager Grid Control allows you to monitor multiple domains and provides configuration management, diagnostics, automation, and historical performance analysis. From Enterprise Manager Grid Control, you can drill down to Oracle Fusion Middleware Control or Oracle WebLogic Administration Console to monitor and administer your Oracle Fusion Middleware environment

- **Oracle Fusion Middleware Control:** Fusion Middleware Control is a Web browser-based, graphical user interface that you can use to monitor and administer a farm. Fusion Middleware Control organizes a wide variety of performance data and administrative functions into distinct, Web-based home pages for the farm, domain, servers, components, and applications. With Fusion Middleware Control, you can perform various tasks like managing the SOA environment, deploying ADF applications, managing Fusion Middleware components, etc.
- **Oracle WebLogic Server Administration Console:** Oracle WebLogic Server Administration Console is a Web browser-based, graphical user interface that you use to manage a WebLogic Server domain. It is accessible from any supported Web browser with network access to the Administration Server. With the WebLogic Server Administration Console, you can perform various tasks like managing the WebLogic Server, managing data sources, JMS resources, etc.

## Process Control

Enterprise Manager Grid Control allows you to perform process control tasks such as starting, stopping, or restarting middleware targets. You can perform these tasks by selecting the Control option in the menu from the Home page of a target. You can also schedule a job to perform these operations. For example, for a WebLogic Server Domain, you can create a job to automatically start, stop, or restart the servers in the domain. You can also view details about the jobs that are scheduled, running, suspended, or the ones that have a problem.

## Creating WebLogic Domain Groups

The WebLogic Domain Group is a custom group that can have WebLogic Domains as members. You can navigate to the page where you can create a WebLogic Domain Group from the All Targets page or the Groups page. A WebLogic Server Domain includes a special WebLogic Server instance called the Administration Server, which is the central point from which you configure and manage all resources in the domain. It also typically includes one or more WebLogic Server instances, called managed servers, on which Java EE applications and components run.

You can perform the following tasks on a WebLogic Domain Group:

- View response and load information of the top 5 servers by average response times.
- View details about the domain such as status, alerts and policy violations, and configuration changes.
- View the resource usage of the top 5 servers by CPU usage percentage.
- See useful performance data related to JMS/JDBC/EJBs/JSPS and servlets of all servers across all domains

## Managing Configurations

Enterprise Manager Grid Control provides a suite of configuration management functions that can be performed on middleware targets.

Oracle Management Agent collects configuration information about Oracle Fusion Middleware targets from their respective configuration files, and communicates this information over HTTP/HTTPS to Oracle Management Service, which stores it in the Management Repository. This information is periodically collected and updated while maintaining the audit of changes. Enterprise Manager's configuration management capabilities efficiently guide the users to desired configuration data in a particular component.

**See Also:** "Hardware and Software Configurations" in [Chapter 4, "Enterprise Configuration Management"](#)

You can compare these configuration details and view the differences and similarities between the two instances of a middleware target. You have the flexibility to compare two last collected configurations or two saved configuration files. You can also compare one configuration with multiple configurations or one configuration in the Management Repository with a saved configuration file.

Using Enterprise Manager Grid Control, you can search configurations across middleware targets and find configuration anomalies - whether they are a mismatch of an install/patch version of Oracle Fusion Middleware software, or they are a mismatch of the software configuration data. You can perform more intelligent searches to identify all the components hosting a particular application or other resources.

In addition, for BPEL Process Manager targets, you can view the BPEL Processes, its different versions, and the suitcase files associated with each version. You can also compare the BPEL Process suitcase files of different versions and track the changes that were made to a version. shows you how the versions can be selected and compared. This allows you to identify the cause for improved or deteriorated performance due to a change in the BPEL Process suitcase file.

## Policy Violations

Enterprise Manager Grid Control also shows the number of informational, warning, and critical policy rules violated for the application server target. You can see the roll up of individual policy compliance scores for that target. Compliance scores provide a quick way to determine the health of the your middleware target. You can also see the policy trend overview for the last 24 hours, for the last week, for the last month, or for a user-define time period, and determine your course of action in solving the policy violations.

Enterprise Manager Grid Control also shows the time when security policy rules were last evaluated, and shows the roll up of individual policy compliance scores for that target.

## Managing Service Levels

Enterprise Manager Grid Control allows you to create infrastructure services for middleware targets such as Oracle BPEL Process Manager targets, Oracle Service Bus targets and Oracle SOA Composite and SOA Infrastructure instances.

An infrastructure service is a dependency service that is created to identify the infrastructure components on which the middleware target depends. Here, the infrastructure components refer to hosts, databases, application servers, and so on that work together to host the middleware target.

You can either create an infrastructure service with a new system or an existing system, or simply refresh an existing infrastructure service, if there is already one existing. By creating infrastructure services and systems, you can better manage your middleware targets and also the components on which the middleware targets depend.

**Figure 9–9 Creating Infrastructure Service for SOA Infrastructure**

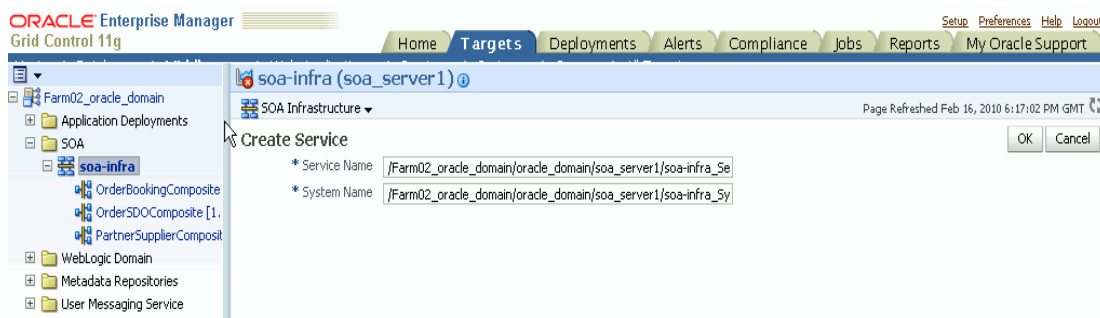

For example, once you create an infrastructure service for an Oracle SOA Infrastructure target, Grid Control allows you to create an aggregate service for every process within that SOA Infrastructure target. An aggregate service is a logical grouping of services, in this case, infrastructure services and availability services. Aggregate Services give you a bird's-eye view of the services that have been created for the SOA Infrastructure target and helps you monitor their availability, performance, and usage. Service availability can be composed of both metrics on the underlying target and service test results from period synthetic transaction execution.

You can define service level (measure of service quality) for a service. A service level is defined as the percentage of time during business hours a service meets specified availability, performance and business criteria.

A Service Level specifies the percentage of time a service meets the performance and availability criteria as defined in the Service Level Rule. By default, a service is expected to meet the specified criteria 85% of the time during defined business hours. You may raise or lower this percentage level according to service expectations. A service level measures service quality using two parameters: Expected and Actual Service Levels.

- **Expected Service Level:** A Service Level specifies the percentage of time a service meets the performance and availability criteria as defined in the Service Level Rule. By default, a service is expected to meet the specified criteria 85% of the time during defined business hours. You may raise or lower this percentage level according to service expectations.
- **Actual Service Level:** The Actual Service Level defines the baseline criteria used to define service quality.

## Automating Operations

The following topics are described in this section:

- Job System
- Provisioning
- Cloning and Patching the Middleware Environment

### Job System

You can use Enterprise Manager Grid Control job system to schedule tasks you want to automate. You can schedule a job for a target by selecting the Control menu option on the Home page. For example, for an Oracle WebLogic Server Domain, you can create a job to automatically start, stop, or restart the servers in the domain.

You can view details about the jobs that are scheduled, running, suspended, or the ones that have a problem. You can also use jobs to automate the execution of the WLST (WebLogic Scripting Tool) scripts.

#### Log File Rotation

Oracle Application Server components generate log files containing messages that record all types of events, including startup and shutdown information, errors, warning messages, access information on HTTP requests, and additional information.

However, the information recorded in log files is voluminous, thus making it difficult to track what update was made at what time. Also because of the huge quantity of information updated periodically, the log files grow in size and occupy more space on the system over a period of time. The only way to manage these log files is to manually archive the contents to another file and store them in a different location.

Considering these impediments, Enterprise Manager Grid Control has been enhanced with a log rotation feature that helps you manage the logs of Oracle Application Server components more effectively. In particular, you can use Enterprise Manager Grid Control to:

- Schedule a job that automatically rotates a log at the scheduled date and time
- Manage space on your system by storing the rotated log files in a different directory

Enterprise Manager Grid Control allows you to view the logs of a particular Oracle Application Server component type and select the ones that need to be rotated. Note that a log rotation job can also be part of a multi-task job.

When a log rotation job is executed, Enterprise Manager Grid Control automatically stops the component whose logs have to be rotated. After it is stopped, the content from its existing log file is moved to another file that is distinguished with the timestamp when it was actually rotated. The original log file is kept empty for new log details to be populated. Once this is done, Enterprise Manager Grid Control restarts the component.

---

---

**Note:** The log rotation feature cannot be used with the WebLogic Server.

---

---

## Operations Automation

Rather than spend resources on manually installing and configuring Oracle Fusion Middleware software, administrators would rather spend time and money on more strategic initiatives. To help achieve this, Enterprise Manager Grid Control has automated common provisioning operations such as cloning Oracle SOA Suite 11g and scaling out an Oracle WebLogic Domain. Making such critical datacenter operations easy, efficient and scalable results in lower operational risk and lower cost of ownership. To access these provisioning operations, navigate to the Deployments page in Enterprise Manager Grid Control and click **Deployment Procedure** and select either of the following:

- Fusion Middleware Provisioning
- Fusion Middleware Domain Scale Up

For more details on using these procedures, see Enterprise Manager Online Help.

### Cloning from Test to Production Environments

Typically, creating a new environment to support SOA applications entails several manual, error prone installation and configuration steps. With Oracle Enterprise Manager this can be accomplished with very little effort and time via a predefined, customizable deployment procedure. This deployment procedure clones an existing SOA Suite environment to a new set of hardware per a hierarchical series of steps. These predefined steps can be edited or disabled and new steps or custom scripts can be added to the deployment procedure to satisfy unique business needs. The deployment procedure also supports secure host authentication using super user do (sudo) or pluggable authentication modules (PAM). While running the deployment procedure, administrators can specify configuration settings such as the domain name, credentials for the administration console, port values, and JDBC data resources. After the procedure completes, the newly created SOA environment is discovered and automatically added to the console for centralized management and monitoring.

### Scaling Out Domains

To address growing business demands, modern data centers must augment and relocate resources quickly. Using Oracle Enterprise Manager, administrators can rapidly scale out a WebLogic Domain and Cluster with additional managed servers to accommodate an increase in application load.

**See Also:** "Cloning" and "Patching" in [Chapter 12, "Lifecycle Management"](#)

---

---

## Identity Management

This chapter describes how you can use Grid Control to manage your Identity Management targets.

This chapter contains the following sections:

- [About Access and Identity Management](#)
- [Using Grid Control for Monitoring Identity Management Targets](#)
- [Identity Management Systems](#)
- [Identity Management Root Cause Analysis](#)
- [Automated Identity Management Monitoring and Alerts](#)
- [Diagnosing Identity Management Performance and Availability Problems](#)
- [Leveraging the Grid Control Management Framework](#)

### About Access and Identity Management

Oracle Identity Management provides a unified, integrated security platform designed to manage user identities, provision resources to users, secure access to corporate resources, enable trusted online business partnerships, and support compliance (identity analytics) across the enterprise.

Oracle Identity management products include the following:

- Oracle Access Manager 10g
- Oracle Identity Manager 9.x
- Oracle Identity Federation 10g and 11g
- Oracle Identity Management Suite 10g (including Oracle Internet Directory, Single Sign-On, Delegated Administration Services, and Directory Integration Platform)
- Oracle Internet Directory 11g
- Directory Integration Platform 11g
- Oracle Virtual Directory 11g

### Using Grid Control for Monitoring Identity Management Targets

Enterprise Manager helps you monitor the availability and diagnose the health of Identity Manager targets within your enterprise configuration. By deploying a Management Agent on each host, you can use Enterprise Manager to discover the

Identity Management components on these hosts, and automatically begin monitoring them using default monitoring levels, notification rules, and so on.

## Identity Component Server Home Page

In Enterprise Manager Grid Control 11g Release 1, an Identity and Access page provides a central site for monitoring all discovered Identity Management components. The Identity and Access page can be added to the Targets sub-tabs by clicking on **Preferences > Target** and by adding **Identity and Access** to the selected target subtabs. From the Identity and Access page, you can discover both Identity Management 10g and Identity Management 11g components, create systems and services based on the end-to-end Identity Management environment, and monitor the health of all discovered Identity Management components from a single page. All Identity Management targets, whether Access, Identity, Identity Federation, and Identity Manager have their own server home pages that provide easy access to key information required by the administrators. Each Identity Management Server home page provides the following information:

- Server status, responsiveness, and performance data. This includes a wide range of out-of-box performance metrics like CPU utilization, failed and successful authentications or authorizations, average response time, provisioning metrics, and up/down status of servers and components), to find root causes of problems that could potentially slow performance, extend response times, or create outages.
- Customizable performance summaries with a **Metric Palette** that allows users to drag and drop performance charts and drill down into usage and performance statistics for:
  - Oracle Identity Federation Providers that show authentication requests and responses, HTTP and SOAP requests and responses, and authentication response processing time.
  - Oracle Internet Directory User Statistics that show failed and completed LDAP operations like Add, Bind, Compare, Delete, Modify, and Search.
  - Directory Integration Platform Synchronization and Provisioning Profiles that show job status, successful, skipped, or failed changes, completion time, and errors.
- Resource usage for the server and its components
- Functionality to start, stop, and restart components
- Configuration Management: Allows you to perform key configuration management tasks like keeping track of configuration changes for diagnostic and regulatory purposes, taking snapshots to store configurations, and comparing component configurations to ensure consistency of configurations within the same or across different environments.

[Figure 10-1](#) shows the Access Manager - Access Server home page.



**Figure 10-1 Access Manager - Access Server Home Page**



## Identity Management Systems

Identity Management services run on Identity Management systems defined in Grid Control. The system includes the software infrastructure components that the Identity services rely on. The system includes components such as databases, HTTP servers, OC4Js, and other servers.

The system is a collection of server targets that are grouped together in Grid Control to give you a view of the "data-center" components that comprise your Identity Management deployment. Identity Management Systems are created when Identity suite components are discovered using Grid Control. Grid Control also monitors the performance and availability of these components and provides a System Dashboard to view the health of the Identity Management system in a single window.

[Figure 10-2](#) shows an Access Manager-Identity System home page:

Figure 10–2 Identity System Home Page

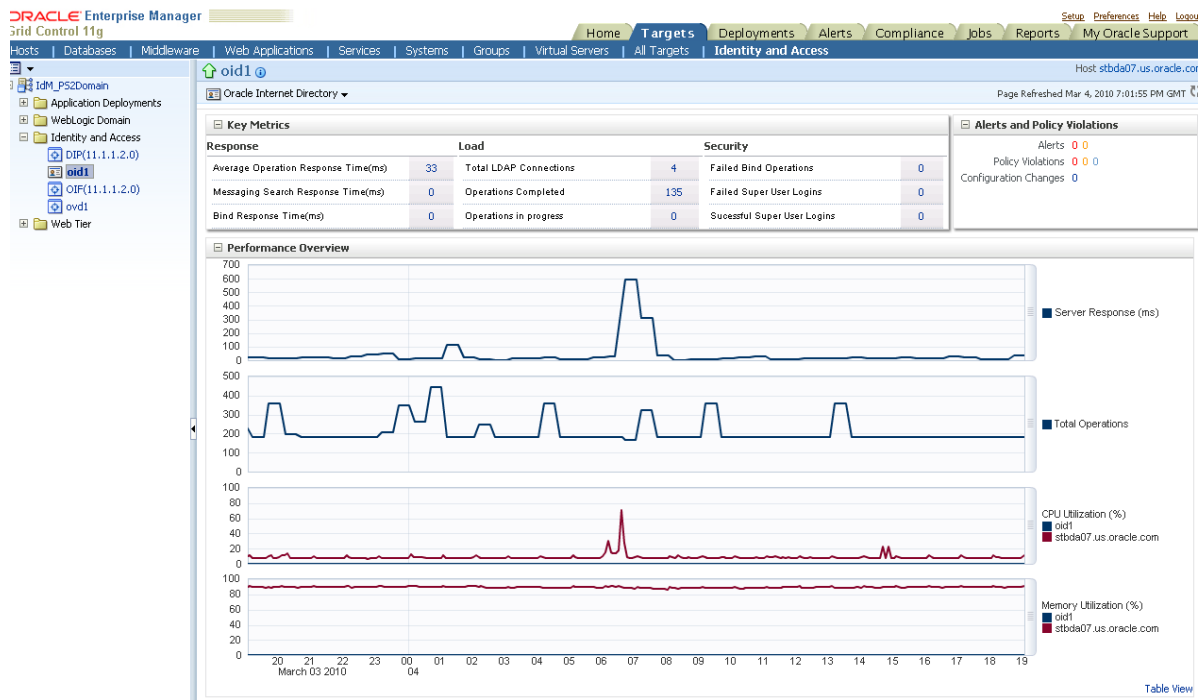

## Configuring Identity Management Services

An Identity Management service is a logical target configured by Grid Control. You use Grid Control to step you through the process of configuring a web application service for your Identity component instances. After you configure a service, that service is displayed on the Services page.

Critical application functions are defined and monitored as services in Grid Control. Each service is monitored by Grid Control beacons, which run service tests that simulate real user access to the service. Service availability and performance are monitored automatically, and problems are immediately reported to the administrator. By monitoring availability and performance of Identity Management services, you can identify and resolve user-visible problems more quickly and thus minimize the impact on users.

## Monitoring Services

Grid Control enables you to monitor all of your Identity Management services. Each service is monitored for performance, usage, and availability.

Each service has its own home page. The Service Home pages in Grid Control provide:

- Status, responsiveness, and performance data
- Resource usage data for the service
- Summary information such as status, performance alerts, usage alerts, and policy violations for the service's subcomponents, including other services and associated systems
- Links to home pages for the service's subcomponents

- Alerts and diagnostic drill-downs so that you can identify and resolve problems quickly
- Services Dashboard

The Services Dashboard provides a high-level view of the status, performance, and usage of each Identity Management target. Service-level compliance for various time periods are also included for each service on the dashboard. You can launch the dashboard directly from Identity system target home page. You can also publish the Services Dashboard so that it can be viewed by non-Enterprise Manager users. This allows you to provide a self-service status web page to your end users.
- Related Links to do the following:
  - View metrics for the service
  - View client configurations
  - Edit the service
  - View the service target's properties
  - Manage blackouts
  - View and manage metric thresholds and policies

**See Also:** [Chapter 8, "Service Management"](#)

## Identity Management Root Cause Analysis

Individual services in Identity Management are associated with critical system components. This allows Enterprise Manager to perform Root Cause Analysis down to the system level whenever a service outage is detected. When you are configuring an Identity Management service in Grid Control, as mentioned in [Configuring Identity Management Services](#), you also mention the critical system components of this service. When an Identity Management service goes down, Enterprise Manager automatically performs a root cause analysis to determine which critical system component is responsible for this.

**See Also:** ["Diagnosing Service Problems"](#) in [Chapter 8, "Service Management"](#)

## Automated Identity Management Monitoring and Alerts

Enterprise Manager automatically gathers and evaluates diagnostic information from Identity Management targets distributed across the enterprise. As with all targets managed by Enterprise Manager, an extensive number of Identity Management performance metrics are automatically monitored against predefined thresholds. Alerts are generated in Grid Control when metrics exceed these thresholds.

## Diagnosing Identity Management Performance and Availability Problems

You can use Grid Control to diagnose performance and availability problems with your Identity Management services. For example, if a service outage occurs, Root Cause Analysis will determine if the primary cause is an outage of a critical service or system component. If a service performance issue is found, an administrator can examine detailed metrics over time related to that service and any of the service or system components used by that service. When you suspect there is a problem with

one or more server components in the Identity Management system, the system home pages provide metrics and charts for diagnosing the issue.

Administrators can monitor the health of all critical Identity Management components, including both Identity Management 10g and Identity Management 11g components. Thresholds may be defined against server and component statistics such as CPU utilization, the number of failed and successful authentications or authorizations, average response time, provisioning metrics (e.g. number of newly provisioned, created, deleted, disabled, locked users), Identity Provider and Service Provider metrics, and up/down status of servers and components.

In addition to relying on system performance metrics, you may use Management Pack for Identity Management Service Tests to record synthetic web transactions that include a combination of one or more navigation paths within the application to be used as the criteria for determining the availability of the service. For example, Oracle Access Manager requires that a user be successfully authenticated and authorized against a certain WebGate for the service to be considered available. Enterprise Manager uses these logical tasks or transactions to define the availability of the Identity Management environment. In addition to synthetic web transactions, Enterprise Manager also supports LDAP tests that allow you to record LDAP operations against a specific LDAP server (including Oracle Virtual Directory). With the LDAP tests, you can specify the username or password, Search Filter, Search Base, and Compare Attribute Name or Value. These synthetic web transactions are recorded, and the stored transaction or service test can be launched at a user-defined interval from strategic locations across the user-base."

**See Also:** ["Monitoring Services"](#) and ["Diagnosing Service Problems"](#) in [Chapter 8, "Service Management"](#)

## Leveraging the Grid Control Management Framework

Grid Control includes many general features that are useful to an Identity Management administrator, including:

- **Job Automation:** You can use the Grid Control job system to schedule tasks you want to automate.
- **Policies:** You can utilize the policy framework to ensure your Identity Management infrastructure adheres to your site-specific standards.
- **Database and Application Server Management:** Using the single Grid Control console, you can also manage the specific databases and application servers in your Identity Management deployment if needed.
- **Extensions:** Grid Control also includes monitoring of key network components that may be part of your Identity Management deployment. You can also extend Grid Control to monitor other components that are not recognized out-of-box by Enterprise Manager.

---

---

## Oracle Beehive Management

This chapter describes how you can use Grid Control to manage your Oracle Beehive targets.

This chapter contains the following sections:

- [About Oracle Beehive](#)
- [Using Grid Control for Monitoring Oracle Beehive Targets](#)
- [Discovering Oracle Beehive Sites](#)
- [Rediscovering an Oracle Beehive Site](#)
- [Editing Availability Definition](#)
- [About Metrics Analysis Report](#)
- [Oracle Beehive System and Services](#)
- [Creating and Resynchronizing Systems and Services](#)
- [Automated Oracle Beehive Monitoring and Alerts](#)

### About Oracle Beehive

Oracle Beehive is the next generation of Oracle's enterprise collaboration technologies. Oracle Beehive provides a unified collaboration application and platform comprised of a comprehensive set of integrated, Java-based services, offering a new paradigm for enterprise collaboration solutions.

Oracle Beehive provides the full range of collaborative services for enterprise users, including:

- E-mail
- Time management
- Instant messaging
- Content and document management
- Task management
- Discussion forums
- Search
- Voicemail
- Contact management
- Mobile device support

- Online presence

The following terms and concepts form the foundation of the Oracle Beehive system, enabling many of the collaboration-based features that it provides:

- Oracle Beehive Service and Service Instances – Oracle Beehive offers discrete, function-specific services that interoperate seamlessly to provide a wide range of features for enterprise collaboration, compliance, third-party component connectivity, coexistence, and so on. In Oracle Beehive, the term service instance refers to a single instantiation of a service on a particular server. The term service typically refers to the collection of all instances of a particular service across all of the servers that host them. In Enterprise Manager, an Oracle Beehive service is called an Oracle Beehive Application and an Oracle Beehive service instance is called an Oracle Beehive Application instance.
- Site – A site is a collection of physical hardware in the same geographic location used to run Oracle Beehive. Each Oracle Beehive site requires a minimum set of components to support a fully-functioning system. However, within each site, multiple instances of a variety of supported components, including services and servers, can be implemented.
- Workspace – A workspace is both a virtual location and a container that provides Oracle Beehive users a place to collaborate, and enables them to create, view, store, access, and manage the artifacts related to their collaborations. From the user perspective, workspaces appear in supported Oracle Beehive clients.

## Using Grid Control for Monitoring Oracle Beehive Targets

Enterprise Manager helps you monitor Oracle Beehive components in your enterprise. You can discover Oracle Beehive components in your environment and add them to Grid Control for central monitoring and management. Enterprise Manager Agents will discover and monitor Oracle Beehive sites, services, and service instances. In Grid Control Oracle Beehive sites, services (called applications), and service instances (called application instances) have home pages.

Following are the target types defined for Oracle Beehive in Grid Control:

- Site – A site is a top-level container for Oracle Beehive deployment in a particular geographic location.
- CalDAV Application and CalDAV Application Instance – Oracle Beehive CalDAV Service supports and manages all time management-related features and settings that the system leverages over the Calendaring Extensions to WebDAV (CalDAV) protocol. Enterprise Manager collects monitoring metrics from all Oracle Beehive CalDAV service instances. These represent metrics for CalDAV application instances. The metrics from instances are aggregated for CalDAV application metrics. Enterprise Manager also collects Configuration parameters for CalDAV application.
- Conference Application and Conference Application Instance – Oracle Beehive Conference Service manages all aspects of Web-based meetings and conferences for Oracle Beehive, enabling meeting organizers and participants to conduct collaborative sessions online through Oracle Beehive workspaces. Enterprise Manager collects monitoring metrics from all Oracle Beehive Conference service instances. These represent metrics for Conference application instances. The metrics from instances are aggregated for Conference application metrics. Enterprise Manager also collects Configuration parameters for Conference application.

- Device Management Application and Device Management Application Instance – Oracle Beehive Device Management application enables system administrators to manage supported client software installed on computers, such as Oracle Beehive Integration for Outlook, and mobile devices. Enterprise Manager collects monitoring metrics from all Oracle Beehive Device Management service instances. These represent metrics for Device Management application instances. The metrics from instances are aggregated for Device Management application metrics. Enterprise Manager also collects Configuration parameters for Device Management application.
- Discussions Application and Discussions Application Instance – Oracle Beehive Discussions application enables organizations to host threaded, online discussion forums in which users can browse message boards, and post and respond to messages. Enterprise Manager collects monitoring metrics from all Oracle Beehive Discussions service instances. These represent metrics for Discussions application instances. The metrics from instances are aggregated for Discussions application metrics.
- E-mail Application and E-mail Application Instance – Oracle Beehive E-mail application supports all aspects of e-mail creation, delivery, and management for Oracle Beehive, by exposing e-mail from coexisting systems to supported clients. The E-mail application enables users to organize and manage their e-mail messages in the context of Oracle Beehive workspaces. Enterprise Manager collects monitoring metrics from all Oracle Beehive E-mail service instances. These represent metrics for E-mail application instances. The metrics from instances are aggregated for E-mail application metrics. Enterprise Manager also collects Configuration parameters for E-mail application.
- FTP Application and FTP Application Instance – Oracle Beehive FTP application supports and manages all content management-related features and settings that the system leverages over the File Transfer Protocol (FTP) and the Secure File Transfer Protocol (FTPS). Enterprise Manager collects monitoring metrics from all Oracle Beehive FTP service instances. These represent metrics for FTP application instances. The metrics from instances are aggregated for FTP application metrics. Enterprise Manager also collects Configuration parameters for FTP application.
- IM (Instance Messaging) Application and IM Application Instance – Oracle Beehive Instant Messaging (IM) application supports all aspects of instant messaging for Oracle Beehive. With the Instant Message application, users can send text-based messages in real time. Users can also attach files to messages, and can broadcast messages to multiple recipients simultaneously, even to entire groups.
- Message Delivery Application and Message Delivery Application Instance – Oracle Beehive Message Delivery application handles all aspects of routing and channel support for Oracle Beehive notifications through Short Message Peer-to-Peer (SMPP), SMTP, and SMS. The Message Delivery application also provides built-in e-mail, instant messaging, SMS, and voice message delivery handlers that can be enabled or disabled, as needed.
- Presence Application and Presence Application Instance – Oracle Beehive Presence application supports and manages all aspects of user and resource presence for Oracle Beehive. Presence is the ability to detect and identify the status of a user or resource, and then display that status to other users and resources.
- PushMail Application and PushMail Application Instance – Oracle Beehive Mobile Mail application manages the features and settings related to push mail for supported mobile devices. The Mobile Push application enables communication between device-resident, device management clients, and the Oracle Beehive

Device Management application. The Mobile Push application also manages the features and settings that are related to the delivery of notifications to supported mobile devices.

- Search Application and Search Application Instance – Oracle Beehive Search Service supports and manages all aspects of user-initiated, text-based searches for Oracle Beehive. It enables users to search for e-mail messages, documents, and meeting entries. Enterprise Manager collects monitoring metrics from all Oracle Beehive Search service instances. These represent metrics for Search application instances. The metrics from instances are aggregated for Search application metrics. Enterprise Manager also collects Configuration parameters for Search application.
- Time Management Application and Time Management Application Instance – Oracle Beehive Time Management application supports all aspects of time and task management, as well as user and resource scheduling for Oracle Beehive. The Time Management application maintains and provides access to the latest schedule information for all Oracle Beehive users and resources.
- WebDAV Application and WebDAV Application Instance – Oracle Beehive WebDAV application supports and manages all content management-related features and settings that the system leverages over the Web-based Distributed Authoring and Versioning (WebDAV) protocol.
- Voice Message Application and Voice Message Application Instance – Oracle Beehive Voicemail application supports all aspects of voicemail and fax management for Oracle Beehive. The Voicemail Service can be leveraged by the E-mail Service, enabling delivery of voicemail messages and faxes as e-mail.
- Workspaces Application and Workspaces Application Instance – Oracle Beehive Workspace application supports all the features and functionality provided by Oracle Beehive personal and team workspaces. Workspaces are the core of the user experience with Oracle Beehive, especially in regard to the collaborative activities of teams. Therefore, the Workspace Service is responsible for consolidating and exposing, in a single location, the collaborative functionality provided by the other Oracle Beehive applications, including the E-mail application, the Time Management application, the Instant Message application, the Discussions application, the Meetings application, the Voicemail application, the Search application, and so on.
- User Directory Application and User Directory Application Instance – Oracle Beehive User Directory application supports all aspects of user directory management for Oracle Beehive, including integration with existing Oracle and third-party user directories.
- XMPP Application and XMPP Application Instance – Oracle Beehive XMPP application supports all aspects of XMPP for Oracle Beehive including support for XMPP 0.9 and 1.0.

## Discovering Oracle Beehive Sites

Enterprise Manager can discover Oracle Beehive sites from remote as well as local agents. Local agents could be used to monitor application instances. Oracle Beehive site, application and application instances discovery, monitoring and configuration parameter collections use the JMX interface exposed by Oracle Beehive's BEEMGMT OC4J. All Oracle Beehive application instances are grouped under the corresponding Oracle Beehive application type. For example, all E-mail application instances will be grouped under a single E-mail application.



To add new Oracle Beehive targets to be monitored by Grid Control, you will need to initiate the discovery process for each Oracle Beehive site.

## Oracle Beehive Site Home Page

The Oracle Beehive Site Home page provides information about:

- All Oracle Beehive applications and application instances within the Oracle Beehive site
- Current Status, Availability, and Site Version
- Site usage for commonly used Oracle Beehive Services including CalDAV, WebDAV, E-mail (IMAP), and XMPP
- Configuring Systems and Services
- Accessing System and Services dashboards for snapshots of the system and service-related information
- Drill-downs to view monitoring metrics and configuration for each Oracle Beehive application and application instance
- Alerts and diagnostic drill-downs so you can identify and resolve problems quickly

You can filter the view based on Physical or Application Deployment of Oracle Beehive. Application Deployment refers to the Oracle Beehive services deployed in an Oracle Beehive site. There can be multiple instances of Oracle Beehive services deployed within one or more OC4J containers. You can further filter the Application Deployment view by applications. Physical Deployment view shows the hosts, Oracle Application Servers, HTTP servers, OC4Js, and the database comprising an Oracle Beehive site. You can further filter this view based on the host, database, or platform components.

[Figure 11-1](#) shows the Oracle Beehive Site home page.

Figure 11–1 Oracle Beehive Site Home Page

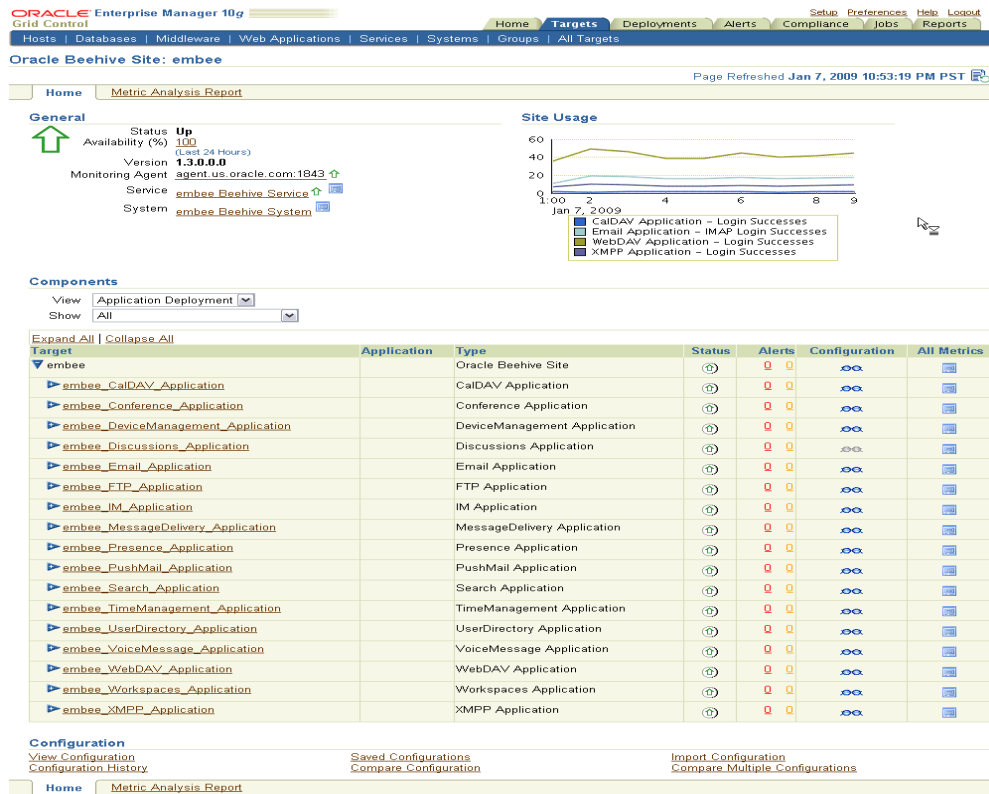

If the Oracle Beehive System and Services have not been created, you can create them by configuring the service tests for the Oracle Beehive Site.

Once the Oracle Beehive System and Services is configured, you can view snapshots of the service and system related information from the service and system dashboards on the Oracle Beehive Site home page. For more information about Oracle Beehive System and Services, see "Oracle Beehive System and Services". For information about Systems and Services in Enterprise Manager, see Chapter 8, "Service Management".

## Rediscovering an Oracle Beehive Site

Enterprise Manager allows you to rediscover an Oracle Beehive site and its sub-components. During rediscovery, all sub-components of Oracle Beehive are compared. Rediscovery of Oracle Beehive includes addition of new Oracle Beehive targets, deletion of Oracle Beehive targets, or changing the configuration of existing Oracle Beehive targets.

---

**Note:** Ensure that you have the necessary privileges to create, delete, and view targets.

---

## Editing Availability Definition

In earlier releases of Grid Control, the application status was computed based on any application instance being down. This algorithm is restrictive since the failure of one application instance may not affect the overall service or application offered to end users. Hence this release introduces a new feature which allows administrators to define the Availability based on their deployment.

You can define the availability of Oracle Beehive application target from the related Oracle Beehive application instance targets. Application availability can be defined based on the number or percentage of Application Instance targets that are up or down. Depending on this definition, the Application availability will be computed and Application status will be set to up or down. For example, if you specify availability as number, say "m" should be up, then at least "m" out of "n" Application instances must be up for the Application status to be up.

To use this feature, from the Oracle Beehive Site home page, click on any Oracle Beehive Application target and access the **Edit Availability** link on the application home page.

## About Metrics Analysis Report

You can view metrics report about Oracle Beehive Site components on the Oracle Beehive Site Metric Analysis Report page. You can choose to view metrics based on Physical or Application Deployment of Oracle Beehive Site. The Physical Deployment option is present only if at least one agent is present on the server where Oracle Beehive or database is installed. Physical Deployment view shows the hosts, Oracle Application Servers, LDAP Servers, HTTP servers, and the database comprising an Oracle Beehive Site.

Application Deployment refers to the Oracle Beehive Services deployed in an Oracle Beehive Site. You can view the Application Deployment by target type. For Application Deployment option, you can choose to view the current snapshot of the metrics or metrics values in the last 31 days, last 7 days, or within the last 24 hours. For the current snapshot view, data is shown as rolled up value for the last 24 hours. You can view the aggregate of all the instances for a target type, displayed as the total of all instances for the application. If the metric is key based, you can also search for target and key columns. The Search option is not available for non-tabular metrics.

## Oracle Beehive System and Services

Since Oracle Beehive offers a set of complex and critical applications and services, it is very important for IT organizations to monitor and manage them for availability and performance. Enterprise Manager Oracle Beehive Site Systems and Services help you to effectively manage Oracle Beehive services from the overview level to the individual component level. Using Grid Control, you can identify and map service unavailability and performance degradation to one or more component failures. Grid Control not only monitors individual components in Oracle Beehive deployments such as hosts, databases, application servers, Beehive Site, Beehive application instances (for example, E-mail application instances, Instant Messaging application instances), etc., but also the applications hosted by those components, allowing you to monitor critical applications using the top down approach and from end-user perspective.

A "Service" in Enterprise Manager is defined as an entity that provides a useful function to its users. It models a business process or application, such as e-mail, time management, instant messaging, and so on. A "System" is a group of underlying components, such as hosts, databases, application servers, etc., on which the Service runs. A "Service test" is a functional test that is run against a service to determine the availability and performance of a service. For example, an IMAP Service test would determine the availability and performance of the E-mail service accessed via standard IMAP protocol. Availability of a service is a measure of the end-users' ability to access the service at a given point in time. Performance indicates the response time as

experienced by the end-users. For information about Services and Systems, see the Service Management and System Management chapters in this guide.

Following is the complete Services hierarchy included in the model template. The hierarchy shown in the wizard is subject to the Oracle Beehive applications deployment. For example, if there is no FTP application discovered during Oracle Beehive Site discovery, the wizard will not include FTP Service in the hierarchy.

- Beehive Site Service
  - Email Service
    - \* IMAP Service
    - \* SMTP Service
  - Time Management Service
    - \* CalDAV Service
  - Presence and IM Service
    - \* XMPP Service
  - Conferencing Service
  - Mobile Service
    - \* Mobile Mail Service
  - Client Service
    - \* Zimbra Service
  - WebDAV Service
  - FTP Service
  - Voice Message Service
  - Workspaces Service
  - User Directory Service

Following is the complete Systems hierarchy included in the model template:

- Beehive Site System
  - Core System
  - Email System
  - Time Management System
  - Presence and IM System
  - Conferencing System
  - Mobile System
  - WebDAV System
  - FTP System
  - Voice Message System
  - Workspaces System
  - User Directory System

Based on the System and Services hierarchy configured through the wizard, an Oracle Beehive Site Service dashboard and an Oracle Beehive Site System dashboard will be automatically generated.

---

---

**Note:** The Core System will be created only if there are agents monitoring the Oracle Beehive hosts, Oracle application servers, databases, LDAP servers, and so on.

---

---

For information about Oracle Beehive service dashboard metrics, see [Appendix A](#).

## Creating and Resynchronizing Systems and Services

You can create/resync systems and services for an Oracle Beehive Site. Use the Create operation to create System/Services model and Resync operation to update the existing System/Services model by adding the newly discovered member targets. The resync operation also identifies new targets that are present in the Oracle Beehive Site topology but are not added to the corresponding system.

When creating a service, you can do the following:

- Create or configure service tests
- View key service members

You can also view the resync changes and accept or reject the changes. Once the resync operation is completed, you can view the changes in the Oracle Beehive Site Service dashboard.

## Automated Oracle Beehive Monitoring and Alerts

Enterprise Manager automatically gathers and evaluates diagnostic information from Oracle Beehive targets distributed across the enterprise. As with all targets managed by Enterprise Manager, an extensive number of Oracle Beehive performance metrics are automatically monitored against predefined thresholds. Alerts are generated in Grid Control when metrics exceed these thresholds.



---

---

## Lifecycle Management

This chapter provides an overview of the server and software provisioning and patching features offered by Enterprise Manager Grid Control. This chapter contains the following:

- [Lifecycle Management Overview](#)
- [Server Provisioning](#)
- [Provisioning Concepts](#)
- [Using the Provisioning Features](#)
- [Patching](#)

The provisioning and patching features together make up the Lifecycle Management (Grid Automation) solution area of Enterprise Manager Grid Control. To read more about this solution area, access the following URL:

[http://www.oracle.com/technology/products/oem/mgmt\\_solutions/provisioning.html](http://www.oracle.com/technology/products/oem/mgmt_solutions/provisioning.html)

### Lifecycle Management Overview

The provisioning and patching features of Enterprise Manager Grid Control automate the deployment of software, applications, and patches using robust, out-of-box deployment procedures. These provisioning and patching deployment procedures make critical data center operations easy, efficient, and scalable resulting in lower operational risk and cost of ownership. The ability to provision and patch the entire software stack that includes the operating system, the middleware, database, third party software, and applications supplemented by comprehensive reporting tools make these features extremely significant entities in the overall System Management space.

As shown in [Figure 12-1](#), using provisioning and patching deployment procedures, Enterprise Manager Grid Control covers the entire lifecycle management of software, applications, and servers. The deployment procedures orchestrate the initial reference sandbox deployment and then the mass unattended deployment of gold images created from these reference deployments.

The smaller lifecycle shown transcribed in the figure automates the ongoing patch lifecycle management of the various deployments. Right from proactively informing the administrators about the critical patches and vulnerabilities in the deployments, acquiring these patches to mass deployment and verification of these patches is automated by the Enterprise Manager Grid Control.

Going forward, as the computation demand for the resources decline, Enterprise Manager Grid Control allows you to deactivate and de-provision the resources making them available for a different purpose.

**Figure 12-1 Lifecycle Management Overview**

## Oracle Management Scope

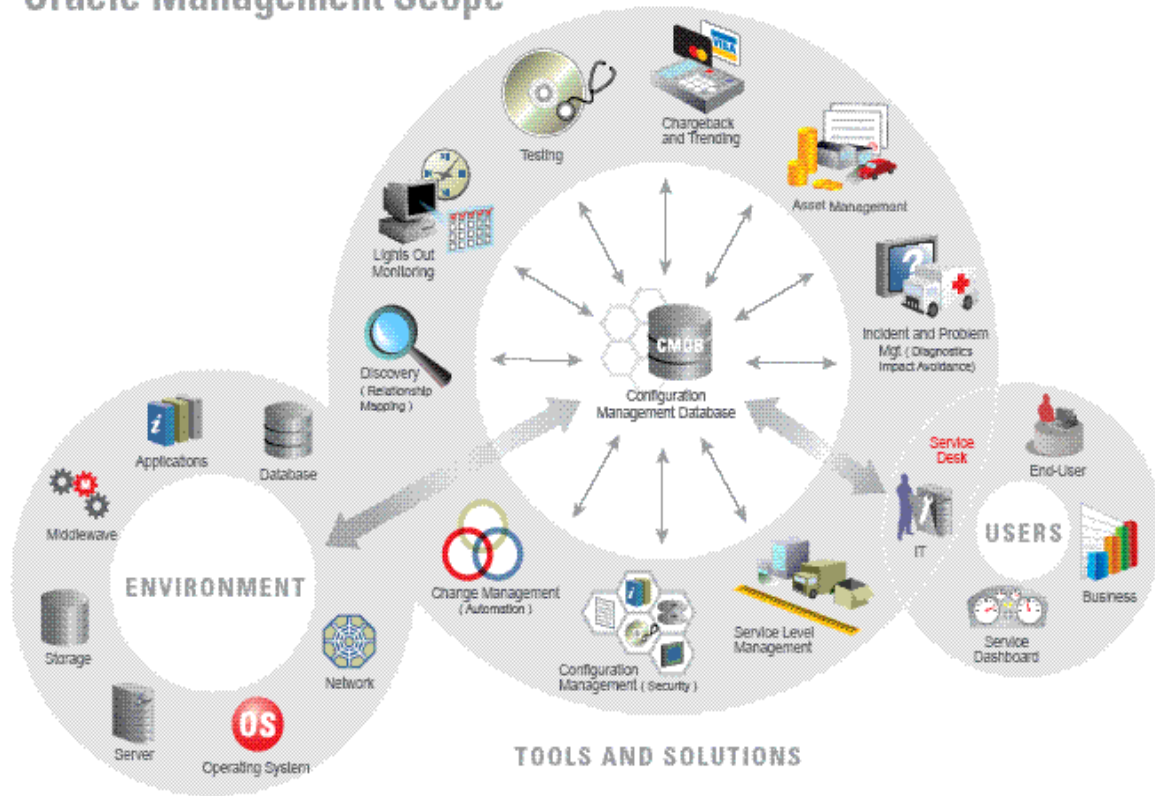

### Advantages of Using Provisioning and Patching Features

The following are the advantages of using the provisioning and patching deployment procedures in Enterprise Manager Grid Control:

- Provides a repeatable, reliable, and automated solution for performing mass, unattended, and schedulable deployment of
  - Software and servers based on Gold Images created using reference deployment or installation media
  - Software and operating system updates
  - Complex and multi-tier software like Oracle Real Application Clusters (RAC) and Fusion Middleware Clusters



- Orchestrates not only provisioning of software but completely automates configuration of software and ensures zero-time for patching of mission critical systems by orchestrating rolling patching for complex multi-tier installation like Real Application Clusters (RAC) databases and Fusion Middleware clusters.
- Allows new resources to be provisioned at short notice based on compliant and tested gold images.
- Automates the patching operations across the stack. For example, for database patching, it takes care of shutting down and starting up database instances as required by the patch.
- Allows multiple operations to be accommodated in a single change window.
- Supports SUDO, PAM, and Privilege Delegation authentication.
- Offers a single interface for multiple players. For example, component designers responsible for creating Gold Images based on corporate standards and the operators all use the same Enterprise Manager Grid Control console.
- Provides automation of repeatable installation and patching operations across the stack leads to substantial cost savings in terms of costs and man-hours.
- Provides Critical Patch Facility that proactively and regularly queries *My Oracle Support* for critical patches that have been released and notifies the administrators of only those patches applicable to them. The Critical Patch Facility also supports an offline mode to serve the case of data centers that are not connected to the Internet.

Enterprise Manager Grid Control also provides command-line interface support to all out-of-box provisioning and patching deployment procedures. These features can hence be invoked by custom scripts.

Enterprise Manager Grid Control also allows you to customize these default deployment procedures to suit your requirements.

## Wide Coverage Across the Stack

Enterprise Manager Grid Control provides provisioning and patching capabilities across the stack for:

- Operating Systems, with Bare Metal Provisioning on Linux and operating system patching
- Databases, with Real Application Clusters (RAC) provisioning, extension, and deletion; Grid Infrastructure provisioning for standalone servers and clustered environments; and flexible patching for Oracle Database and Oracle Real Application Clusters
- Middleware, with Oracle Fusion Middleware provisioning, Oracle SOA Suite provisioning, and SOA Artifacts provisioning, BPEL provisioning, Oracle Service Bus provisioning

Note that these features require Oracle Management Agents to be present on the destination hosts where the software has to be provisioned.

## Server Provisioning

Bare metal or Operating System provisioning application provides server lifecycle management to build, manage, and optimize server infrastructure. The application:

- Automates deployment of consistent, certified Linux operating system images along with larger number of servers on physical and virtual servers.
- Automates deployment of hypervisors and virtual machines.
- Provides a template-based approach for provisioning a variety of Linux configurations servers (RedHat 3.0/4.0, SuSE/SLES9). This also ensures compliance to standards and consistency across all deployments.
- Reduces errors with standardized gold image-based server provisioning.
- Supports heterogeneous hardware and network configuration.
- Automatically discovers bare metal and live target servers for provisioning.
- Especially for Oracle software, the application encodes best practices out-of-the-box for patching.
- Results in considerable reduction in manual labor that leads to substantial cost savings.

For detailed use cases and capabilities of the Bare Metal Provisioning application, refer to the *Oracle Enterprise Manager Administrator's Guide for Software and Server Provisioning and Patching* available at:

<http://www.oracle.com/technology/documentation/oem.html>

## Customization

The provisioning and patching deployment procedures offered by Enterprise Manager Grid Control are default procedures that have been created considering all the best practices in the industry. The steps embedded within a deployment procedure ensure that they meet all your provisioning and patching requirements. You can, of course, use them with the default settings to provision or patch your targets in the environment, however, you also have the choice of customizing them to include additional custom steps, disable unwanted steps, and use authentication tools to run some steps as another user.

You can also customize the deployment procedures to run them as another user, ignore the steps that require special privileges, add new steps, run custom scripts as part of the procedure, implement different error handling methods, and so on. You can run the above-mentioned deployment procedures using EMCLI commands.

For information about customization of deployment procedures, see *Oracle Enterprise Manager Administrator's Guide for Software and Server Provisioning and Patching* available at:

<http://www.oracle.com/technology/documentation/oem.html>

## Provisioning Concepts

Following are the basic elements associated with provisioning.

### Components

Components represent the primary building blocks that may be combined with other components as needed, to specify the complete software configuration or image that is provisioned on target machines. A component can represent operating system software, Oracle software or any third party software and applications. Software components are individually maintained within the Oracle Software Library. Versions, states, and maturity levels can be associated with each component.

## Directives

Directives can be imagined as instructions to cook the final image (recipe) using components (ingredients). These are constructs used to associate scripts with software components and images. These scripts contain directions on how to interpret and process the contents of a particular component or an image. Directives encapsulate the script, the command line used to invoke the script, and the script configuration properties. They capture everything required for invoking the script on a machine during a provisioning operation. Directives are usually categorized based on the provisioning life cycle phases they are targeted for, or the actions they perform. Imagine Directives as set of executable instructions that run from a supported shell (for example, `borne-again`, Perl, Python), programming language (for example, Java), or execution framework or interpreter (such as “make” or “ant”). Directives are contained within a file stored in the Oracle Software Library and referenced from the software components that employ them.

Components and Directives are used by Deployment Procedures (both out-of-box and custom procedures) to mass deploy software and applications on to target servers.

## Images

An image can be viewed as a set of components and may include directives that form the required software configuration, which is deployed on the target machines. An image contains the complete software stack from operation system to application, in the form of its components and is used for provisioning servers from ground up with the entire stack provisioned on them. Images reference the components they logically contain by version (rather than include them directly). Images are stored in the Oracle Software Library and versions, states, and maturity levels can be associated with them.

## Software Library

Enterprise Manager allows a shared location accessible from the Oracle Management Server (OMS) to serve as a Software Library. Software library serves as the central repository for metadata and binary content for components, images, and directives. It allows maintaining versions, maturity levels, and states of components, directives, and images.

---

---

**Note:** For server provisioning, other basic elements like Network Profiles and Assignments are required. Refer to the Concepts section in the Best Practices for Grid Control based Bare Metal Provisioning White Paper.

---

---

## Using the Provisioning Features

Following are the one-time configuration activities for using the provisioning features.

### Setting up and configuring the environment

For both software and server provisioning the user needs to perform a one-time activity of setting up a Software Library. For server provisioning additional elements like Boot server, Stage server, and RPM repository have to be configured as required by the provisioning application. Once configured, the same elements will be used for any software or server-provisioning operation performed using the provisioning application.

## Creating Components, Directives, and Images

Once the environment is ready, the user can use the Enterprise Manager user interface to create components, directives, or images for deploying them onto the target servers. This is explained in [Figure 12-2](#).

**Figure 12-2** *Creating Software Components Using Enterprise Manager User Interface*

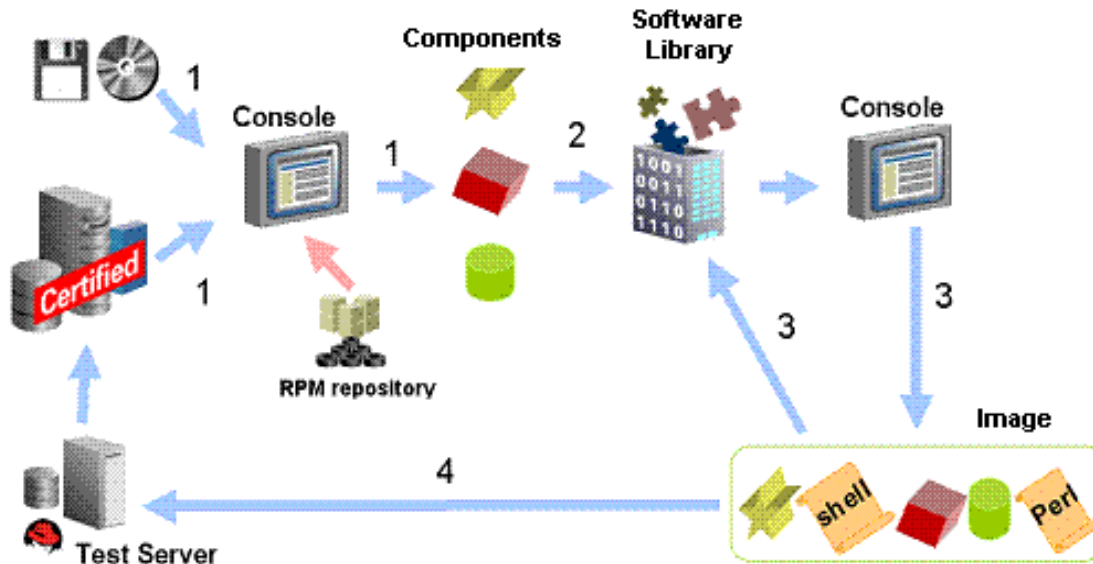

- You can use either tested reference installations or installation media to create software components from the Enterprise Manager User Interface. The RPM repository is used for creating the out-of-box operating system components that one needs to provision on the bare metal or live servers. You can use the Enterprise Manager User Interface to create Directives and other server provisioning constructs like Storage templates, Hardware templates, and Network templates.
- The reusable entities created above are stored in the Software Library.
- These reusable entities can then be used by deployment procedures for deployment or mixed and matched to create deployable images for the hardware servers, which are again stored in the software library.
- The images or components can then be deployed on test or production environments.

## Patching

Manually applying software patches to maintain the latest and most secure IT environment can become a full-time job. With Enterprise Manager's deployment management tools, you can quickly see the patches available for the components in your enterprise, find out which have not been applied and which are critical, then bring those deployments up to the latest patch level with out-of-box best practices.

The enriched patching application offers an "end-to-end" patching solution that works seamlessly across a wide range of product patches and customer environments. The patching application automates the deployment of patches for the Oracle Database, including Clusterware and Oracle RAC, as well as Oracle Application Server. Also,

Out-of-box procedures are provided for patching Operating Systems - Linux (Oracle Enterprise Linux, RHAT, and SUSE), Solaris, and Windows.

Using a direct link to My Oracle Support patch repository, the Critical Patch Facility identifies the critical patches that have been released for the Oracle software running in your specific systems, and notifies administrators of only those patches that are applicable to their environment. Once a patch is identified, Grid Control can orchestrate the download and deploy it on multiple targets automatically.

Enterprise Manager provides the following patching features:

- [My Oracle Support Integration](#)
- [Patching Through Deployment Procedures](#)
- [Patching Features](#)
- [Patch Recommendations](#)
- [Application Server Patching](#)
- [Linux Host Patching](#)
- [Operating Systems Patching](#)
- [Accessing Patching Pages in Grid Control](#)

## My Oracle Support Integration

My Oracle Support is now integrated with Enterprise Manager Grid Control. This integration provides system administrators with a single console that personalizes their support experience along with seamless management of their IT environments. In the My Oracle Support console, you can view patch recommendations, create patch plans for organizing rollouts, validate conflicts, download an existing merged patch, request a new patch, and directly automate the deployment of patches.

The Patch Recommendations region provides a single view of all Security and Recommended patches that should be deployed across your environment. Patch Plans provide end-to-end patch automation by identifying patches and the affected targets, validating conflicts, merging available patches, or by automating the deployments. You can now validate conflicts, download existing merged patches or a send a new merge request from a single integrated console.

## Patching Through Deployment Procedures

Deployment procedures are the best practices for orchestration of patching Oracle Software such as Databases including Real Application Clusters, Clusterware, Automated Storage Management, Application Servers, and Operating Systems. The Deployment procedure-based infrastructure has been leveraged to increase the power and flexibility of Oracle patching for complex multi-tier environments. The out-of-box Deployment Procedures are Oracle-provided best practices that can be customized for specific needs. Users can enable and disable or add custom steps for specific actions and create the best practice for their environment. This activity is a one-time design activity typically of the lead DBA, which can be the standard and carried over by the operator for the entire environment.

Deployment procedures also support secure host authentication using sudo or PAM. The entire exercise can be run in the command line (CLI) mode, thereby making it possible to integrate with the existing scripts. Refer to Enterprise Manager Advanced Configuration for details on Using Deployment Procedures.

---



---

**Note:** For patching Oracle Management Agents, use the patch wizard, which can be accessed by clicking the **Patch Agent** link under Patching section in the Deployments page.

---



---

## Patching Features

Grid Control's patching tools simplify the patching of Oracle software products. Some key features are listed in [Table 12-1](#).

**Table 12-1 Features of Patching**

Feature	Description
Software Library	<p>The Library to store patches, directives or components. Can be used in offline mode of patching. You can upload patches to Software library using the View/Upload Patch link.</p> <p>Refer to <i>Using the Software Library</i> section in Oracle Enterprise Manager Advanced Configuration for details on Software Library.</p>
Critical Patch Advisories	<p>Lists all critical advisories with their corresponding areas of impact.</p> <p>Critical Patch Advisories also provides support for "remedies," in that you can select an advisory and view the calculated remediation paths from the context of that advisory, as well as the affected Oracle homes.</p>
Online Patching	Allows you to connect to My Oracle Support through Grid Control, search and download the required patches, and apply.
Offline Patching	Allows you to perform all the patching activities through Software Library. Even when you are not connected to My Oracle Support, you can search, download, and apply patches.
My Oracle Support	Searches My Oracle Support Web site for Oracle patches and patch sets. Or use Grid Control to search after you provide your My Oracle Support Web site user name and password.
Patching Setup	<p>Helps you configure My Oracle Support, patching, proxy connection, and offline patching settings.</p> <p>Note that if you are accessing a proxy server to get to My Oracle Support, you will need to provide proper authentication and credentials.</p>
Patching through Deployment Procedure	<p>Oracle ships a set of best practices Deployment Procedures to accomplish provisioning and patching related tasks. Deployment Procedures can be extended and customized for customer needs. This allows:</p> <ul style="list-style-type: none"> <li>■ SIDB, RAC/Clusterware patching in rolling modes</li> <li>■ Helps you stage patches (and also to the central location) and apply them to the required Oracle homes</li> <li>■ When patching database by targets, provides additional options that allow you to shut down the database, apply SQL scripts (and start the database in Upgrade mode), and start up the database again</li> <li>■ Integration with Notification systems for various statuses</li> </ul>
Agent Patching	Patching Oracle Management Agents through the Patch Agent link. This applies agent-specific patches and also generic patches like CORE or DST patches on the Agent.

**Table 12–1 (Cont.) Features of Patching**

Feature	Description
Shared Agent Patching	Automates patch applications on shared agents when they are NFS-mounted. During Shared Agent Patching, patches the central location where the agent is installed, shuts down and starts up the shared agents, and executes any pre/post-patching scripts (if specified).
Support for SUDO/PAM-based patching	Deployment procedures Secure host authentication for patching using SUDO/PAM.
Notification	This feature notifies users by identifying Criticality on the targets across the Target pages.
Oracle Home Credentials	When you override preferred credentials, you can choose to either specify one set of credentials for all Oracle homes, or specify different credentials for each home.
Information Publisher	Provides a powerful central reporting framework that produces detail and summary reports on patch deployments and non-compliant installations. Supports both out-of-box and ad hoc reporting to satisfy different customer needs.  The Library to store patches, directives or components. Can be used in offline mode of patching. You can upload patches to Software library using the View/Upload Patch link.  Refer to <i>Using the Software Library</i> section in the Oracle Enterprise Manager Advanced Configuration for details on Software Library.

## Patch Recommendations

You can use Grid Control to manage Oracle Patch Recommendations. These include security patches that address security vulnerabilities across all targets managed by Oracle Enterprise Manager and all other recommended patches.

- **Assess Vulnerabilities:** This helps identify the Oracle Software affected by the advisory. The list displays comprehensive details on the Patch Recommendations applicable on specific products under version and platform. This also displays the affected Oracle Homes.

Grid control automates the entire process of critical patch application. It performs an assessment of vulnerabilities by examining your enterprise configuration to determine which Oracle homes have not applied one or more of these critical patches. Grid Control provides a list of critical patch advisories and the Oracle homes to which the critical patches should be applied.

Some Oracle software patches have been identified as critical. To help ensure a secure and reliable configuration, all relevant and current critical patches should be applied to the appropriate targets in your enterprise.

From the summary of patch advisories, you can navigate for more information about a particular patch, and get a list of the Oracle homes to which the patch has not been applied. Then you can launch the Enterprise Manager Grid Control Patch tool to download and deploy the patches to multiple targets.

- **User Notification:** This feature notifies users by identifying Criticality on the targets across the Target pages. Also, with the notification and reporting one can receive notifications and reports for the Patch Recommendations and its assessment.

- Application of recommended patches: The patch application process is automated directly from the assessment and the patch is downloaded from My Oracle Support and orchestrated:
  - Directly automate the patch application process using procedures
  - Download patches directly from My Oracle Support and apply
  - Schedule to apply patches on multiple targets simultaneously
- Configuration update: After applying the patch, the configuration is updated with the latest and reports can be generated based on the applied patches.

**See Also:** "Managing Patch Recommendations" in the Enterprise Manager Grid Control online help and Oracle Enterprise Manager Advanced Configuration.

### Applying Patch Recommendations in Offline Mode

The Patch Recommendation feature enables administrators to simply download the Recommendation XML from My Oracle Support and upload it to the repository. Click **Setup > Patching Setup > Online and Offline Settings** and download the Recommendation XML which can then be used by the "RefreshFromMyOracleSupport" job for performing Critical Patch calculations in offline mode. Administrators will be alerted to security updates—even if the Management Service is not connected to My Oracle Support.

Some data centers are not connected to the outside world. The Patch Recommendation offline mode feature makes it easy to keep your environment patched to the latest level. Subsequent patching can be done in offline mode as well, using the Software Library infrastructure.

### Accessing Patch Recommendation Pages in Enterprise Manager Grid Control

To access the Patch Recommendation pages in Enterprise Manager Grid Control:

- Click the **Deployments** tab, then click the **Security Recommendations** link in the Recommended Security Patches section.
- Click **Deployments** and then click the **Patches & Updates** tab.
- Click **My Oracle Support** and then click the **Patches & Updates** tab.
- Click the **Security Recommendations** link on the Enterprise Manager Grid Control Home page.

This takes you to the My Oracle Support page, where you can view advisories, patch sets, and patches to apply, as well as affected Oracle homes and available "remedies."

## Application Server Patching

The patching application automates the deployment of Oracle patches for the application server and Management Agents. The application takes care of appropriate shutdown and startup of services and also allows execution of pre and post patching scripts to serve different use cases. Such flexibility makes mass deployment of interim patches and patchsets feasible even in complex multi-tier environments.

## Linux Host Patching

The "Patch Linux Hosts" tool, a powerful new feature in Grid Control, facilitates the automated management of Linux hosts in an enterprise. Use this feature to keep the



Linux hosts in your enterprise up to date with vital software updates from your Linux vendor.

Patch Linux Hosts uses a reference-based grouped patching model, where you can create one or more reference package repositories containing up-to-date versions of various packages, and associate a group of Linux hosts with these package repositories.

The Patch Linux Hosts tool uses package repositories to patch the hosts as well as to monitor the deviation of the packages installed on the hosts. You can create different groups suited to your administrative needs and even associate different package repositories with different priorities for each group. You can independently control when and how often to update the hosts in the group, and how to determine their compliance with respect to the package repositories.

---

---

**Note:** To use this feature, make sure you have the following:

- Licenses for the Provisioning and Patch Automation Pack
  - Linux Management Pack
  - "Operator" privileges on the host that you want to patch
  - Ability to do sudo to the root user
- 
- 

The Linux patching feature provides the following functionalities:

- Setting up and managing RPM Repositories by subscribing to Unbreakable Linux network (ULN) channels
- Setting up and managing custom RPM Repositories and channels (cloning channels, copying packages from one channel into another, and deleting channels)
- Setting up Linux Patching Group to update a group of Linux hosts and compliance reporting from the Linux Patching group
- Scheduling Patching for non-compliant groups
- Managing Configuration file channels (creating/deleting channels, uploading files, and copying files from one channel into another)
- Patching through deployment procedures and emergency patching
- Undo Patching feature

### Enhanced Linux Patching for ULN

Enhanced Linux Patching feature of Enterprise Manager supports the Unbreakable Linux Network (ULN) subscribers through EM. ULN provides access to Linux software patches, updates and fixes for its customers. Oracle provides three levels of Unbreakable Linux support:

- Network Support - access to patches and updates via ULN
- Basic Support - access to patches and updates via ULN, 24x7 support, complete Linux server lifecycle management
- Premier Support - access to patches and updates via ULN, 24x7 support, Linux server lifecycle management, backporting, lifetime support

The Linux RPM Repository Server Setup page in Enterprise Manager allows you to set up a RPM repository server for Linux patching. You can select the Host to setup the

RPM repository server and register the host to the Unbreakable Linux Network (ULN).

### Patching Features

- **Linux Host Patching Groups:** You can group a set of Linux hosts together to update all at once. Each group is associated with one or more package repositories that contain all the certified and appropriate versions of the software packages for the hosts of that group. Each group is configured with an update schedule for a recurring job to run to update the hosts with the associated package repositories.

**See Also:** "Creating a New Linux Host Group" in the Grid Control online help

- **RPM Repository:** RPM repository is a directory that contains RPM packages. The RPM repository is accessible via http or ftp. A RPM repository can be organized to contain packages from multiple channels.
- **Custom Channel:** A custom channel is a channel created by the user to store a set of custom RPM packages. Custom channels can be added to the RPM repository.
- **Configuration Channel:** A channel that is created by the user to store a set of Linux configuration files. Configuration channels can be used in the Linux patching application user interface to update configuration files on Linux hosts.
- **Compliance and automatic updates:** The compliance page contains information on the number of hosts in a group that are in compliance, as well as the number of "rogue" packages on a particular host. You can see metrics and charts to measure compliance for all Linux Host Patching Groups, as well as historical compliance data.
- **Emergency Patching:** This feature gives you the option of performing "forced" updates, outside of the established schedule, to immediately respond to critical bugs or security alerts for all configured Linux hosts.
- **Undo Patching:** This feature adds flexibility by allowing you to roll back the software to its previous stable version, or even de-install the unstable version completely if that software version was found to be unsuitable or to have a bug or security vulnerability.
- **Patching through Deployment Procedures:** You can use deployment procedures to set up RPM repository, patch linux hosts, and perform other custom patching procedures.

## Operating Systems Patching

Enterprise Manager supports patching of Solaris, Linux, and Windows Operating Systems. For Solaris, you can directly connect to the vendor's Website and download patches.

In addition to proactive patching method mentioned in the section above, Enterprise Manager also supports ad-hoc patching of Linux, Windows and Solaris operating systems using native patching methods.

## Accessing Patching Pages in Grid Control

To access the patching pages in Grid Control:

- Click the **Deployments** tab, then click the links found under the Patching section:

- 
- Patching Through Deployment Procedures - This link takes you to the Deployment Procedure Manager page. Deployment procedures are best practices provided by Oracle for various Provisioning and Patching tasks. Procedures created by Oracle cannot be edited, but can be extended using 'Create Like', so that you can customize the procedure to fit your environment.
  - View/Upload Patch - This link takes you to the Patch Cache page and it provides a list of patches available in the Patch Cache as well as the Software library. These are patches that have been either automatically downloaded from My Oracle Support or manually uploaded to the patch cache.
  - Patch Linux Hosts - This link takes you to the Patch Linux Hosts page and helps keep Linux hosts up-to-date with vendor updates.
  - Patch Agent - This link takes you to the Agent Patching wizard.
  - Click **Setup**, then click **Patching Setup** from the navigation pane. From this page, you can configure your settings for My Oracle Support and patching, proxy connection, offline patching, and Linux Staging server.



---

---

## Virtualization Management

This chapter introduces the concepts in virtualization management in the following sections:

- [Introduction to Virtualization Management](#)
- [Getting Started With Virtualization Management](#)
- [Provisioning Guest Virtual Machines](#)
- [Bare Metal Provisioning of Oracle VM Servers](#)
- [Monitoring Oracle VM](#)
- [Administering Oracle VM](#)
- [Migrating from Oracle VM Manager to Enterprise Manager](#)

### Introduction to Virtualization Management

Virtualization management involves the monitoring, administration, and maintenance of virtual servers and guest virtual machines in your enterprise. Oracle provides the customer increased value by extending Enterprise Manager capabilities to monitor virtualized entities alongside the physical infrastructure and perform complete lifecycle management of guest virtual machines and software running on them.

---

---

**Note:** Enterprise Manager supports only Oracle VM server version 2.1.2 or above. Refer to Support Note 781879.1 for OVS agent requirement and instructions to enable Oracle VM Management functionality in Enterprise Manager Console.

Oracle recommends that no more than 24 Oracle VM servers be registered and managed with one Oracle Management Agent.

---

---

The management solution for Oracle VM servers and guest virtual machines running on them provides capabilities in the following areas:

- Performance and availability monitoring for virtualized environments
- Lifecycle management (provisioning and patching) for virtual servers and guest virtual machines
- Configuration and compliance management

The following figure depicts the relationship between Oracle VM servers, guest virtual machines, and Enterprise Manager:

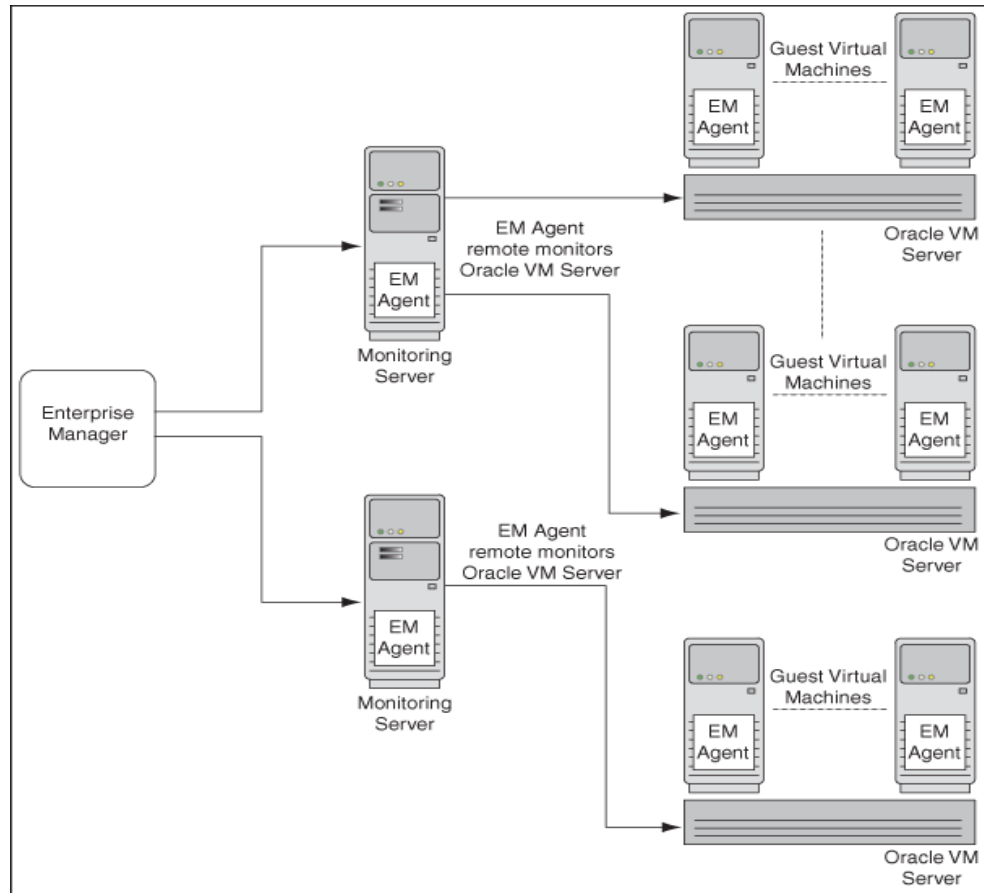

---

**Note:** Oracle VM servers are remotely monitored by Enterprise Manager. One agent can monitor multiple virtual servers. The Enterprise Manager agent monitoring Oracle VM servers must be of version 10.2.0.5.0 or higher. Enterprise Manager agent must not be installed on virtual servers.

---

## Virtualization Concepts

Following are commonly-used terms in virtualization:

### Oracle VM

Oracle VM is a server virtualization software. Installing Oracle VM on a bare metal box allows for the creation of multiple guest virtual machines on it. Just like Oracle databases and Oracle Fusion Middleware, Oracle VM is available for download on Oracle Technology Network (OTN).

### Virtual Server

Virtual Server is a generic term used to describe a physical box running virtualization software (hypervisor) on it. A new virtual server can be provisioned by installing Oracle VM server software on a bare metal physical box. "Virtual Server" is a target type in Enterprise Manager that represents the Oracle VM targets.

Every Oracle VM server can perform one or more of the functions described below:

- **Master Server function**

The Master Server is the core of the server pool operations. It acts as the contact point of the server pool to the outside world, and also as the dispatcher to other servers within the server pool. The load balancing is implemented by the Master Server. For example, when you start a guest virtual machine, the Master Server will choose a Guest VM Server with the maximum resources available to run the guest virtual machine. There can be only one Master Server in a server pool. The state of a virtual server pool is equivalent to the state of the master virtual server.

- **Utility Server function**

The Utility Server is responsible for I/O intensive operations such as copying or moving files. Its function focuses on the creation and removal operations of guest virtual machines, virtual servers, and server pools. There can be one or more Utility Servers in a server pool. When there are several Utility Servers, Server Pool Master chooses the Utility Server with the maximum CPU resources available to conduct the task.

- **Guest VM Server function**

The primary function of the Guest VM Server is to run guest virtual machines, thus acting as a hypervisor. There can be one or more Guest VM Servers in a server pool. When there are several Guest VM Servers, Master Server chooses the Guest VM Server with the maximum resources available (including memory and CPU) to start and run the virtual machine.

### **Monitoring Server**

The monitoring server monitors the virtual server remotely. Multiple virtual servers are monitored by one agent. Enterprise Manager agent must not be installed on virtual servers.

### **Virtual Server Pool**

A Server Pool is a logical grouping of one or more virtual servers that share common storage. A virtual server can belong to only one virtual server pool at a time. Guest virtual machines and resources are also associated with server pools. Oracle VM Server Pool is an aggregate target type in Enterprise Manager to represent the server pool of Oracle VM Servers.

When the Oracle VM Server Pool is created, the user is asked to provide the details of the Master Server for that pool. By default, this Oracle VM Server also performs the functions of the Utility Server and Guest VM Server.

The user can later change the Utility Server and Guest VM Server functions using the Edit Virtual Server action.

### **Guest Virtual Machine**

Guest Virtual Machine (also known as Guest VM) is the container running on top of a virtual server. Multiple guest virtual machines can run on a single virtual server. Guest virtual machines can be created from Oracle VM templates. Oracle VM templates provide pre-installed and pre-configured software images to deploy a fully configured software stack. Oracle VM templates can be downloaded from OTN at the following location:

<http://www.oracle.com/technology/products/vm/templates.html>

A guest virtual machine monitored by an Enterprise Manager agent is treated like any other Host target. This type of guest virtual machine is referred to as a "Managed Guest VM".

A guest virtual machine that is not monitored by any Enterprise Manager agent is referred to as an "Unmanaged Guest VM". Only limited monitoring and configuration information is available for such a guest virtual machine.

## Supported Releases

Following are some of the supported operating system versions for virtualization:

**Table 13–1 Supported Releases**

<b>Operating System</b>	<b>Version</b>
Linux	Oracle Enterprise Linux 4 - 32-bit and 64-bit
	Oracle Enterprise Linux 5 - 32-bit and 64-bit
	Red Hat Enterprise Linux 3 - 32-bit and 64-bit
	Red Hat Enterprise Linux 4 - 32-bit and 64-bit
	Red Hat Enterprise Linux 5 - 32-bit and 64-bit
Windows	Microsoft Windows Server 2000
	Microsoft Windows Server 2003 Edition - 32-bit and 64-bit
	Windows Vista
	Windows XP
UNIX	Solaris 10

## Virtualization Central Page as the Management Hub

You can navigate to Virtualization Central from the Grid Control Home page by clicking on the **Targets** tab and then the **Virtual Servers** sub-tab. [Figure 13–1](#) shows the Virtualization Central page.



Figure 13–1 Virtualization Central Page

Hosts | Databases | Web Applications | Services | Systems | Groups | Virtual Servers | All Targets

## Virtual Servers

Page Refreshed May 7, 2009 2:46:58 AM PDT

Virtualization Central [Software Components](#)

This page displays monitoring and configuration information about virtual servers and guest virtual machines. You can also administer and provision virtual servers and guest virtual machines here.

Search   [Advanced Search](#)

Action

[Select All](#) | [Select None](#)

Select	Name <sup>△</sup>	Type	Status	Server Pool	Virtual Server	Operating System	Alerts	Policy Violation	Compliance Score (%)	CPU Util (%)	Memory Util (%)
<input type="checkbox"/>	guestVM1	Guest VM	Running	oexen-pool	oexen-server3.idc.oracle.com					.1	
<input type="checkbox"/>	myguest1	Guest VM	Running	oexen-pool	oexen-server3.idc.oracle.com					.1	
<input type="checkbox"/>	NewPool	Virtual Server Pool	Up								
<input type="checkbox"/>	oexen-pool	Virtual Server Pool	Up								
<input type="checkbox"/>	oexen-server3.idc.oracle.com	Virtual Server	Up	oexen-pool		Oracle VM server release 2.1.2	<span style="color: red;">Q</span> <span style="color: red;">Q</span>	<span style="color: red;">Q</span> <span style="color: red;">Q</span> <span style="color: red;">Q</span>	Unavailable	3.05	53.88
<input type="checkbox"/>	stbdm12.us.oracle.com	Virtual Server	Up	NewPool		Oracle VM server release 2.1.2	<span style="color: red;">Q</span> <span style="color: red;">Q</span>	<span style="color: red;">Q</span> <span style="color: red;">Q</span> <span style="color: red;">Q</span>	Unavailable	Unavailable	Unavailable

Virtualization Central [Software Components](#)

### Related Links

[Bare-Metal Provisioning](#) [Customize Table Columns](#) [Deploy Agent](#)

[Home](#) | [Targets](#) | [Deployments](#) | [Alerts](#) | [Compliance](#) | [Jobs](#) | [Reports](#) | [Setup](#) | [Preferences](#) | [Help](#) | [Logout](#)

Enterprise Manager Virtualization Central page shows the following:

- A quick view of the status of the virtual server and guest virtual machines and basic information about them
- CPU and Memory utilization of virtual servers
- Information about the server pool to which the virtual servers are registered
- Drilldowns to server pools, virtual servers, and guest virtual machines home pages from where you can view more information about these targets
- Allows you to perform administrative tasks such as starting and stopping guest virtual machines
- Allows you to perform provisioning activities such as creating virtual server pools, registering virtual servers, and creating guest virtual machines
- Provides a VNC Console to access guest virtual machines

Starting from the Virtualization Central page, you can access additional details and management functions by drilling down through the user interface. In addition, the Virtualization Central page provides a list of Related Links. From these links you can perform activities such as bare metal provisioning of Oracle VM server software, customization of table columns, and deployment of Enterprise Manager agent on a guest virtual machine.

---



---

**Note:** The Monitoring Server agent (Enterprise Manager agent that monitors Oracle VM servers) should be upgraded to version 10.2.0.5.0.

---



---

## Getting Started With Virtualization Management

This section details the virtualization infrastructure you will need to set up to start monitoring and managing your virtualization systems:

1. Create a virtual server pool. For information about creating a virtual server pool, see [Creating Virtual Server Pool](#).
2. Register virtual servers with the virtual server pool. For information about registering virtual servers, see [Registering Virtual Servers](#).
3. Create and manage guest virtual machines. For more information about creating guest virtual machines, see [Provisioning Guest Virtual Machines](#).

---



---

**Note:** Following are the prerequisites to provision virtualization systems:

- Preferred credentials must be set.
  - Software Library must be set up. For information about setting up the Software Library, see *Appendix C, Using a Software Library in Enterprise Manager Administrator's Guide for Software and Server Provisioning and Patching*.
- 
- 

[Table 13–2](#) lists the privileges required to perform administrative and provisioning tasks on server pools, virtual servers, and guest virtual machines.

**Table 13–2 Privileges for Provisioning and Administrative Operations in Virtualization Central**

Task	Privileges
Create Virtual Server Pool	Add any Target system privilege
Remove Virtual Server Pool	Full privilege on the Server Pool Target and the member Virtual Servers
Manage Virtual Server Pool	Operator privilege on the Server Pool Target
Create Guest Virtual Machine	Operator privilege on the Server Pool Target
Discover Guest Virtual Machine	Operator privilege on the Server Pool Target

**Table 13–2 (Cont.) Privileges for Provisioning and Administrative Operations in Virtualization Central**

<b>Task</b>	<b>Privileges</b>
Clear Operation Error (Virtual Server Pool)	<p>The Privilege check depends on the operation that has failed.</p> <ul style="list-style-type: none"> <li>■ If Create Virtual Server Pool action has failed: User must be the job owner or must have Super Administrator privileges</li> <li>■ If Remove Virtual Server Pool has failed: User must have Full privilege on the Server Pool Target and the member Virtual Servers as well</li> <li>■ If Stop Virtual Server / Reboot Virtual Server operation on the Master Virtual Server had failed: User must have Operator privilege on the Master Virtual Server and the Server Pool Target</li> </ul>
Convert P2V	Operator privilege on the Server Pool Target
Convert V2V	Operator privilege on the Server Pool Target
Register Virtual Server	Add any Target system privilege
De-register Virtual Server	Full privilege on the Virtual Server and the Server Pool Target
Edit Virtual Server	Operator privilege on the Virtual Server and the Server Pool Target
Enable Server Maintenance Mode	Operator privilege on the Virtual Server
Remove Server Maintenance Mode	Operator privilege on the Virtual Server
Live Migrate All Guest Virtual Machine	<p>Operator privilege on the source Virtual Server and the Server Pool Target.</p> <p>Since the destination virtual server gets selected automatically and may be any virtual server in the Server Pool, Operator privilege on all member virtual servers of the Server Pool Target is essential.</p> <p>If preferred servers are set for the guest virtual machine, you will need Operator privilege on preferred virtual servers only.</p>
Stop Virtual Server	Operator privilege on the Virtual Server and the Server Pool Target
Reboot Virtual Server	Operator privilege on the Virtual Server and the Server Pool Target
Clear Operation Error (Virtual Server)	<p>Privilege check depends on the operation that has failed.</p> <ul style="list-style-type: none"> <li>■ If Register Virtual Server has failed: User must be the job owner or must have Super Administrator privileges</li> <li>■ If De-register Virtual Server has failed: User must have Full privilege on the Server Pool Target and the Virtual Servers as well</li> <li>■ If Stop Virtual Server/Reboot Virtual Server operation has failed: User must have Operator privilege on the Master Virtual Server and the Server Pool Target</li> </ul>

**Table 13–2 (Cont.) Privileges for Provisioning and Administrative Operations in Virtualization Central**

<b>Task</b>	<b>Privileges</b>
Live Migrate Guest Virtual Machine	Operator privilege on the source Virtual Server and the Server Pool Target.  Since the destination virtual server gets selected automatically and may be any virtual server in the Server Pool, Operator privilege on all member virtual servers of the Server Pool Target is needed.  If preferred servers are set for the guest virtual machine, you will need Operator privilege on preferred virtual servers only.
Clone Guest Virtual Machine	Operator privilege on the Server Pool Target
Save Guest Virtual Machine as Template	Operator privilege on the Server Pool Target
Edit Guest Virtual Machine	Operator privilege on the Virtual Server and the Server Pool Target.  An Edit Guest VM action may be performed on a Halted guest virtual machine as well. In this case privileges will be checked only on the Server Pool Target.
Update Preferred Server List	Operator privilege on the Virtual Server and the Server Pool Target.  If the preferred server selection is set to Automatic, the guest virtual machine may come up on any virtual server within the server pool hence, you must have Operator privilege on all the members virtual servers in the server pool Target.  If the preferred server selection is set to Manual, you must have Operator privilege on the specified list of member virtual servers.
Delete Guest Virtual Machine	Full privilege on the Server Pool Target
Stop Guest Virtual Machine	Operator privilege on the Virtual Server and the Server Pool Target
Start Guest Virtual Machine	Operator privilege on the Server Pool Target.  If the preferred server selection for that guest virtual machine is set to Automatic, the guest virtual machine may come up on any virtual server within the server pool. Hence, you must have Operator privilege on all the members virtual servers in the Server pool Target.  If the preferred servers for that guest virtual machine is set to Manual, you must have Operator privilege on the specified list of member virtual servers.
Reboot Guest Virtual Machine	Operator privilege on the Virtual Server and the Server Pool Target.
Pause Guest Virtual Machine	Operator privilege on the Virtual Server and the Server Pool Target
Un-pause Guest Virtual Machine	Operator privilege on the Virtual Server and the Server Pool Target
Suspend Guest Virtual Machine	Operator privilege on the Virtual Server and the Server Pool Target

**Table 13–2 (Cont.) Privileges for Provisioning and Administrative Operations in Virtualization Central**

Task	Privileges
Resume Guest Virtual Machine	Operator privilege on the Server Pool Target. If the preferred server selection for that guest virtual machine is set to Automatic, the guest virtual machine can come up on any virtual server within the server pool. Hence, you must have Operator privilege on all the members virtual servers in the Server pool Target. If the preferred server selection for that guest virtual machine is set to Manual, you must have Operator privilege on the specified list of member virtual servers.
VNC Console	Operator privilege on the Virtual Server and the Server Pool Target
Clear Operation Error (Guest Virtual Machines)	Privilege check depends on the operation that has failed. <ul style="list-style-type: none"> <li>■ If Delete Guest VM has failed: User must have Full privilege the Server Pool Target</li> <li>■ If Start/Stop/Reboot/Pause/Un-pause/Suspend/Resume Guest VM has failed: User must have Operator privilege the Server Pool Target</li> <li>■ If Create/Clone/Migrate/Edit/Save has failed: User must have Operator privilege the Server Pool Target</li> </ul>
View Virtual Server/Guest Virtual Machine	View privilege on the Virtual Server Pool. If the User has Full/ Operator/View privilege on the Virtual Server Pool then the user gets View privileges on all the member Virtual Server targets automatically.

## Creating Virtual Server Pool

For Enterprise Manager to manage Oracle VM servers, you will need to create a virtual server pool. Each virtual server pool must have at least one Oracle VM virtual server. The first virtual server added to the pool acts as the master server for the server pool.

[Figure 13–2](#) shows the Create Virtual Server Pool page. You can specify a virtual server pool and the master server.

**Figure 13–2 Create Virtual Server Pool Page**

Virtualization Central >

### Create Virtual Server Pool

Provide details of the virtual server pool and the master virtual server you want to register with Enterprise Manager.

\* Virtual Server Pool Name   
 Shared Directory   
 High Availability Mode  Enable  
 Master Server Virtual IP   
Virtual IP to connect to the master virtual server and support the master server failover. This input is required only for Oracle VM ver

#### Master Virtual Server Details

\* Virtual Server Host   
Name of master Virtual Server

\* Monitoring Server Agent    
EM Agent that will monitor the Virtual Server

\* Monitoring Server User   
Operating system user that owns the EM Agent home

\* Monitoring Server Password   
Credentials for operating system user that owns the EM Agent home

\* SSH Username   
SSH Username to connect to Virtual Server

\* SSH Password   
SSH Password to connect to Virtual Server

\* Oracle VM Agent Password   
OVN Agent Password on Virtual Server

\* Staging Directory   
Directory location on Virtual Server that can be used by EM to stage management scripts

You will need to specify the following fields:

- Virtual Server Pool Name — Specify the name of the virtual server pool that you are creating.
- Shared Directory — Specify the directory mounted as the shared directory. This shared directory is the same for all virtual servers within a virtual server pool.  
 For example, /OVS. All guest virtual machine templates and running guest virtual machines are maintained in this location.
- High Availability Mode — Select Enable if you want the virtual server to participate in high availability. For more information about setting high availability for server pools, see *Enterprise Manager Administrator's Guide for Software and Server Provisioning and Patching*.
- Master Server Virtual IP — If you have chosen to enable high availability mode, optionally specify an unused IP address to support master server failover, and to be used as virtual IP for master server communication.
- Virtual Server Host — As part of the virtual server pool creation, one virtual server needs to be specified, which will act as the Master Server for the server pool. Specify either FQDN name or IP address of the master virtual server for the server pool.
- Monitoring Server Agent — Virtual servers in a server pool are monitored remotely by an Enterprise Manager Grid Control agent. Specify the agent that will monitor the virtual servers.
- Monitoring Server User that owns the Enterprise Manager agent home/agent install and has read and write permission on agent home directory.

- Monitoring Server Password — Password for the user that owns the Enterprise Manager agent home/agent install.
- SSH Username and Password — User name and password for Enterprise Manager to SSH into the virtual server machine.
- Oracle VM Agent Password — Every Oracle VM server has an in-built Oracle VM agent running on it. Specify the password for this agent.
- OVS Proxy Location — This is a directory on the virtual server where the scripts required for monitoring are stored when the virtual server is registered with Enterprise Manager. This location must be different from the shared directory specified earlier.

## Registering Virtual Servers

After creating a virtual server pool, you can register the virtual servers with the server pool (Figure 13–3).

**Figure 13–3 Register Virtual Server Page**

Virtualization Central >

### Register Virtual Server

Add details of the Virtual Servers to be registered. Cancel OK

**Batch Assignment** Assign

Enter values in input fields and click on Assign button to update the same in below table

Virtual Server Host:  Name of the Virtual Server.

Monitoring Server Agent:  GC Agent that will monitor the Virtual Server

Monitoring Server Username:  Username of GC Agent's owner

Monitoring Server Password:  Password of GC Agent's owner

SSH Username:  SSH Username to connect to Virtual Server

SSH Password:  SSH Password to connect to Virtual Server

Oracle VM Agent Password:  Password of OVM agent running on the Virtual Server

OVS Proxy Location:  Staging location on Virtual Server

Virtual Server Pool:  Server Pool that this Virtual Server will join

Remove Duplicate | Add Another Row Add From File |

Select All | Select None

Select	Virtual Server Host	Monitoring Server Agent	Monitoring Server Username	Monitoring Server Password	SSH Username	SSH Password	Oracle VM Agent Password	OVS Proxy Location
<input type="checkbox"/>	Virtual_server1	dhcp-10-143-183-157.us.oracle.com	testt_user	*****	example_user	*****		staging_loc

To register virtual servers, specify the fields described in Table 13–3.

**Table 13–3 Register Virtual Server Details**

Element	Description
Virtual Server Host	Specify the name of the master virtual server for the server pool.
Monitoring Server Agent	Specify the monitoring agent.
Monitoring Server User	Specify the Operating system user that owns the Management Agent home/Management Agent install, and has read and write permission on agent home directory.

**Table 13–3 (Cont.) Register Virtual Server Details**

Element	Description
Monitoring Server Password	Specify the password credentials for the monitoring server user.
SSH Username	Specify the user on the virtual server who has sudo privileges.
SSH Password	Specify the password credentials for the SSH user.
Oracle VM Agent Password	Specify the password of the Oracle VM Agent running on the virtual server.
OVS Proxy Location	Specify a directory on the virtual server where the scripts required for monitoring and administration are stored when the virtual server is registered with Enterprise Manager.
Virtual Server Pool	Specify the virtual server pool to which the virtual server will belong.

## Provisioning Guest Virtual Machines

You can do the following provisioning activities from the Virtualization Central page:

- **Creating guest virtual machines**

Guest virtual machines can be created from Oracle VM templates, ISO images, and PXE-booting across the network.

Enterprise Manager also allows conversion of physical machines to Oracle virtual machines and conversion of existing VMware/Virtual Iron virtual machines to Oracle virtual machines. Conversion of Virtual Iron V2V to virtual machines is supported only for Oracle VM version 2.2 and above.

- **Cloning guest virtual machines**

Cloning creates a copy of a guest virtual machine on the same server pool. When a guest virtual machine is cloned, the software on the source guest virtual machine is also copied onto the cloned guest virtual machine.

- **Live migrating guest virtual machines**

Enterprise Manager Grid Control allows users to live migrate one or all guest virtual machines running on a virtual server. Applications running in the guest virtual machines continue to be accessible during live migration. Live migration ensures high availability of guest virtual machines.

- **Saving guest virtual machine as a template**

A guest virtual machine can be saved as a template in the same server pool or in the Software Library and used for provisioning other guest virtual machines.

- **Importing and discovering guest virtual machines, templates, and ISO images**

Oracle VM templates and ISO binaries can be imported to the server pool and used for provisioning guest virtual machines. You can store your Oracle VM templates in the shared `/OVS/seed_pool` directory and ISO images in the `/OVS/iso_pool` directory and add them as resources to the server pool using the Discover functionality.

Deployment procedures for provisioning Oracle VM are provided out-of-box. Deployment Procedures cannot be run directly. Deployment procedures for Oracle VM provisioning run when provisioning is performed through Virtualization Central.



## Creating Guest Virtual Machines

You can create guest virtual machines from the following three sources:

- Using Oracle VM Templates
- Using ISO images of Linux and Windows operating systems
- PXE bootable guest virtual machines that can boot over a network

Oracle VM template or ISO binaries can be available in any of the following locations:

- In the Software Library as a software component
- In the virtual server pool as a resource
- In a HTTP or NFS accessible external location

**Figure 13–4** Create Guest Virtual Machines Wizard

The screenshot shows the 'Create Guest Virtual Machines: Configure' wizard page. The page is titled 'Create Guest Virtual Machines: Configure' and has navigation buttons for 'Cancel', 'Back', 'Step 3 of 5', and 'Next'. The configuration options are as follows:

- Virtual Machine Name Prefix: gvm1
- Root Password: [Masked]
- Confirm Root Password: [Masked]
- Number Of Cores: 1
- Memory Size (MB): 1024
- VNC Console Password: [Masked]
- Confirm VNC Console Password: [Masked]
- Number of Network Interfaces: 2
- CPU Scheduling Priority: Intermediate
- CPU Cap (%): High
- Start VM after creation:
- Enable High Availability Mode:
- Configure Agent:

Local Devices from Source Template:

Disk Name	Capacity(MB)	QoS Priority Class
agent	2000	Not Enabled
system	6145	Not Enabled

Additional Disks: No Additional Disks

Shared Disks: No Shared Disk

Figure 13–4 shows the Create Guest Virtual Machines: Configure page from the guest virtual machine creation wizard.

For information about creating guest virtual machines using ISO images and PXE boot, see chapter *Provisioning Virtualization Systems* in the *Enterprise Manager Administrator's Guide for Software and Server Provisioning and Patching*.

If you want to restrict certain guest virtual machines to run on only certain Oracle VM servers, use the Preferred server list feature. Preferred server list contains all the Oracle VM servers on which this guest virtual machine is allowed to run. If the "Automatic" option is selected when creating a guest virtual machine, Enterprise Manager picks the Oracle VM server with maximum resources to run the guest virtual machine. When auto-restarting guest virtual machines during fail-over scenario, Enterprise Manager picks a preferred Oracle VM server to auto-restart the guest virtual machine.

Navigate to the Create Guest Virtual Machines: Configure page and specify the following fields:

- Virtual Machine Name Prefix — This string will be used as a prefix in the guest virtual machine name. When a guest virtual machine is created using the Enterprise Manager Grid Control Console, guest virtual machine names will be prefixed by the virtual machine name prefix you provide here and a number.

- **Root Password** — This is the operating system "root" password to log into the guest virtual machine once it is up and running.
- **Number Of Cores** — Number of CPU cores to assign to this guest virtual machine. This will show up as virtual CPU (vCPU) configuration parameter for the guest virtual machine.
- **Memory Size (MB)** — The amount of memory to be allocated to the guest virtual machine. The physical virtual server machine should have sufficient memory to run the guest virtual machine. Otherwise, the guest virtual machine will be created, but will not be started.
- **VNC Console Password** — Enterprise Manager provides a VNC console to the newly created guest virtual machine. This is the VNC password to access the VNC console.
- **Number of Network Interfaces** — Number of virtual network interfaces this guest virtual machine should have. The minimum value is 1 and the maximum value is 8.
- **CPU Scheduling Priority** — Specify the priority of a guest virtual machine to access the physical CPUs, while competing with other guest virtual machines on the same virtual server. Higher the priority, higher is the stake of the guest virtual machine in claiming CPU cycles.
- **CPU Cap (%)** — Restricts the amount of physical CPU that a guest virtual machine can use. Use this to constrain guest virtual machine resource allocation.
- **Start VM after creation** — Specify whether the guest virtual machine should be started automatically after it is created.
- **Enable High Availability Mode** — When creating the guest virtual machine, if the "Enable High Availability Mode" flag is selected, this guest virtual machine will participate in the High Availability functionality. If its parent virtual server fails, this guest virtual machine will be auto-restarted on another Oracle VM server.

Select this option if you want the guest virtual machine to restart automatically on a different virtual server if the earlier virtual server shuts down.

Enabling High Availability mode for the virtual server pool allows all the Oracle VM servers in the pool to be clustered. This provides for high availability / fail-over support. For more information about high availability failover for server pools, see *Enterprise Manager Administrator's Guide for Software and Server Provisioning and Patching*.

To enable High Availability, you will need the following configuration:

- High Availability mode should be set for the virtual server pool.
- Clustering configuration should be done for Master Server and other virtual servers in the server pool.
- High Availability flag must be set for the guest virtual machines.
- **Configure Agent** — Select this option if you want to configure the agent to monitor the guest virtual machine.
- **Local Devices from Source Template** — Displays the local devices from source template. You can enable disk priority by setting an appropriate QoS Priority Class. The priority class ranges from 0 to 7. The priority class 0 has the highest priority, and 7 the lowest.
- **Additional Disks** — Every guest virtual machine is created with at least one disk. Specify additional disks and their sizes. These disks will be added to the guest

virtual machine. After the guest virtual machine is created, log into the guest virtual machine and reformat and mount the additional disks.

Specify the name of the hard disk, its size, and QoS Priority Class. You can enable the disk I/O priority by setting an appropriate QoS Priority Class. The priority class ranges from 0 to 7. The priority class 0 has the highest priority, and 7 the lowest.

- **Shared Disks** — Oracle VM allows sharing of disks between multiple guest virtual machines. Specify shared disks that the guest virtual machines can access.

If the server pool has no shared disk available, the Add button will be disabled. Only virtual machines within the same server pool can share a shared disk.

Specify the shared device name, the shared disk on it, and the QoS Priority Class. You can enable the disk I/O priority by setting an appropriate QoS Priority Class. The priority class ranges from 0 to 7. The priority class 0 has the highest priority, and 7 the lowest.

## Bare Metal Provisioning of Oracle VM Servers

Oracle allows you to provision Oracle VM server using PXE/kickstart. For more information about bare metal provisioning of Oracle VM server, see chapter *Provisioning Linux Operating System* in the *Enterprise Manager Administrator's Guide for Software and Server Provisioning and Patching* available at:

[http://download.oracle.com/docs/cd/B16240\\_01/doc/doc.102/e14500/toc.htm](http://download.oracle.com/docs/cd/B16240_01/doc/doc.102/e14500/toc.htm)

During bare metal provisioning of Oracle VM server, the Management Agent will not be installed. After completing bare metal provisioning, register the Oracle VM server with the server pool.

---



---

**Note:** To perform bare metal provisioning of Oracle VM servers, from Oracle Enterprise Manager Grid Control Home page, navigate to the **Deployments** tab, click on **Provisioning**, and then navigate to the **Administration** tab.

---



---

## Monitoring Oracle VM

Enterprise Manager provides comprehensive monitoring to enable you to identify the problem areas in your virtualization environment.

Enterprise Manager automatically gathers and evaluates diagnostic information from Oracle VM targets distributed across the enterprise. As with all targets managed by Enterprise Manager, an extensive number of Oracle VM metrics are automatically monitored against predefined thresholds. Alerts are generated in Grid Control when metrics exceed these thresholds.

### Oracle VM Server Home Page

On the Oracle VM server home page ([Figure 13-5](#)), you can view basic information about the Oracle VM server including status, availability, operating system details, alerts, and guest virtual machines running on the Oracle VM server.

Following are the graphs described on the Oracle VM server home page:

- The CPU Utilization graph provides information about the total physical CPU utilization(%) of the Oracle VM server.
- The Memory Utilization graph provides information about the physical memory utilization(%) of the Oracle VM server.
- The Disk Space Utilization graph provides information about the free and used local disk (partitioned) space on the Oracle VM server.

The Guest Virtual Machine section shows the following metrics for each of the guest virtual machines running on this Oracle VM Server.

- Virtual Machine Name - The name of the guest virtual machine running on the Oracle VM Server.
- Target Name - The Host target name if this is a managed guest virtual machine.
- State - One of the possible states of the guest virtual machine. The state can be either "Running" or "Paused".
- Uptime - Displays how long this guest virtual machine has been "Running". This also includes the time this machine has been in the "Paused" state.
- CPU | vCPUs - Displays the number of Virtual CPUs this guest virtual machine has.
- CPU | Util(%) - Displays the amount of CPU utilization with respect to Total Physical CPU Utilization.
- Memory | Allocated - Displays the amount of memory allocated to this guest virtual machine.
- Memory | Util(%) - Displays the amount of memory utilized with respect to the memory allocated to the guest virtual machine.
- Virtual Block Device I/O (KB/sec) | Read - Displays the amount of data read from the block device.
- Virtual Block Device I/O (KB/sec) | Write - Displays the amount of data written to the block device.
- Virtual Network I/O (KB/sec) | Received - Displays the amount of data received by the Virtual Network interfaces.
- Virtual Network I/O (KB/sec) | Transmitted - Displays the amount of data transmitted by the Virtual Network interfaces.

Figure 13–5 Virtual Server Home Page

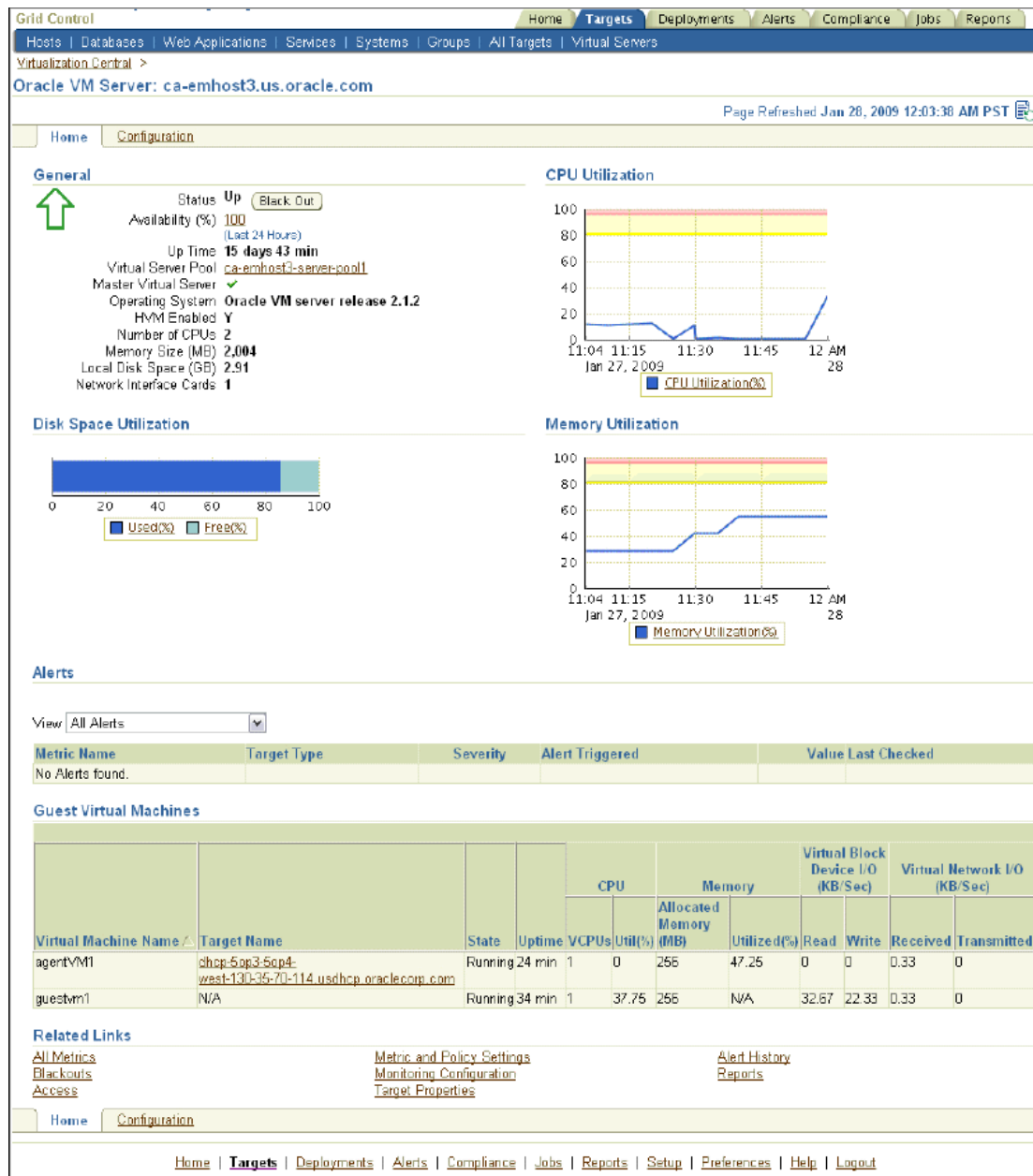

From the home page, you can drill down to more detailed performance information.

## Guest VM Home Page

The Guest Virtual Machine Home page is available only for managed guest virtual machines. It is similar to the Host Home page in Enterprise Manager. On this page, you can view basic information about the guest virtual machine including configuration details, alerts, policy violations, job details, patch advisories details, and security details. For more information about hosts, see [Host and Third-Party Target Management](#).

To get the complete benefits of managing and monitoring guest virtual machines using Enterprise Manager, the guest virtual machine must have an agent installed on it.

**Figure 13–6 Guest Virtual Machine Home Page**

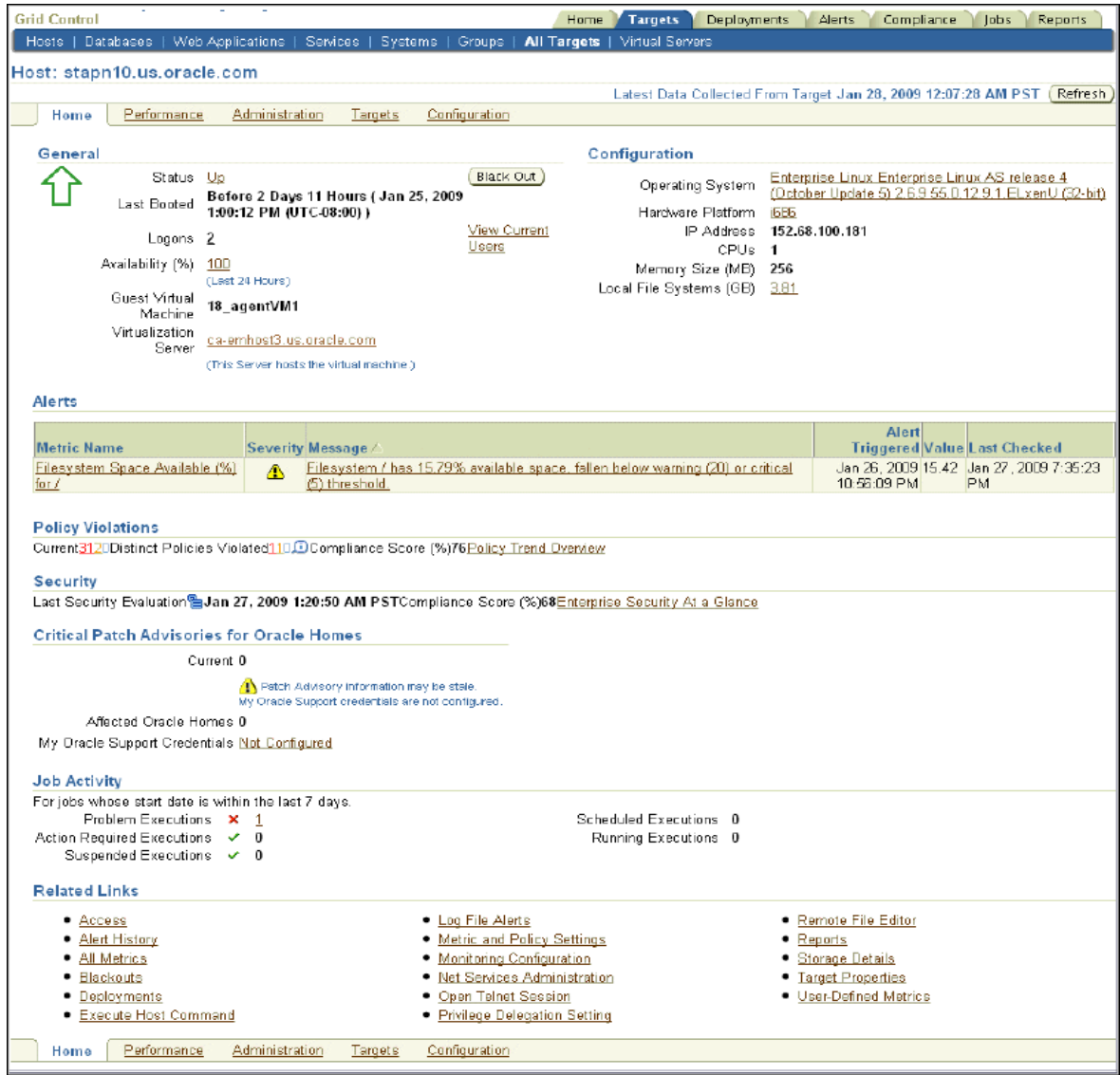

## Administering Oracle VM

Oracle Enterprise Manager effectively keeps your Oracle VM available and running efficiently. Specifically, it provides a graphical user interface for managing Oracle VM server, guest virtual machines, and server pools. As with Oracle VM monitoring, administration of Oracle VM begins with the Virtualization Central page. You can perform administration tasks such as the following:

- Create, remove, and manage virtual server pools
- Register, deregister, edit, reboot, and stop virtual server
- Start, stop, suspend, resume, pause, un-pause, and edit guest virtual machines

A guest virtual machine can have the following additional status:

1. **Operation Error** - This is an intermediate status. The guest virtual machine moves to this status when an operation fails. The user has to perform the Clear Operation Error action to move the guest virtual machine out of this status.
2. **Error** - This status indicates that there are some errors with the guest virtual machine, and it cannot be used.
3. **Unknown** - This status indicates that Enterprise Manager has not been able to collect the state of the guest virtual machine.

**Table 13–4 Guest Virtual Machine Actions**

<b>Action</b>	<b>Applicable Status</b>	<b>Multi-Select/Single-Select</b>
Live Migrate Guest VM	Running	Single-select
Clone Guest VM	Halted	Single-select
Save Guest VM as Template	Halted	Single-select
Edit Guest VM	Halted/Running	Single-select
Update Preferred Server List	Halted	Single-select
Destroy Guest VM	Halted/Error/Unknown	Multi-select
Start Guest VM	Halted/Error/Unknown	Multi-select
Stop Guest VM	Running/Paused/Error/Unknown	Multi-select
Reboot Guest VM	Running	Multi-select
Pause Guest VM	Running	Multi-select
Un-pause Guest VM	Paused	Multi-select
Suspend Guest VM	Running	Multi-select
Resume Guest VM	Suspended	Multi-select
VNC Console	Running	Single-select
Clear Operation Error	Operation Error	Single-select

Figure 13–7 shows the guest virtual machine state transition.

**Figure 13–7 Guest Virtual Machine State Transition Diagram**

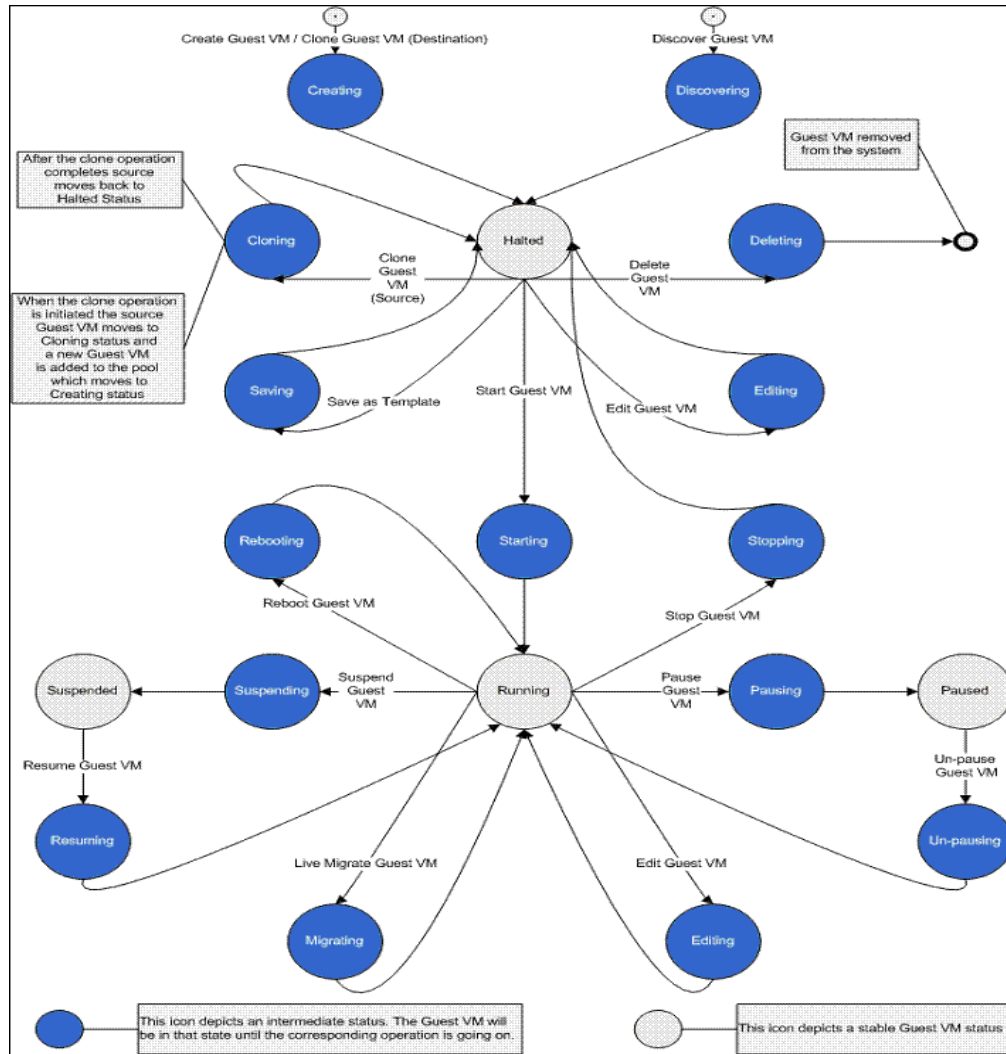

## Editing Guest VM

A guest virtual machine can be edited as shown in [Figure 13–8](#).



**Figure 13–8 Edit Guest Virtual Machine Page**

Edit Guest Virtual Machine: fft165

Cancel Continue

General Disk Storage Network Interface Advanced

Review and modify the configuration of the Guest Virtual Machine.

\* Virtual Machine Name

Status **Halted**

Server Pool Name **ovshwm**

\* Memory (MB)

\* Dynamic Memory (MB)   
Dynamic Memory size must be atleast 256 MB

\* Virtual CPUs   
Change in cpus will take effect on next restart of the Virtual machine.

Description

\* VNC Console Password

\* Confirm VNC Console Password

CPU Scheduling Priority Intermediate   
Oracle VM Server will schedule the physical CPU cycles, based on the CPU Scheduling Priority of the Guest VM

CPU Cap (%) High   
Oracle VM Server will limit the allocation of physical CPU cycles, based on the CPU Cap of the Guest VM

You can edit the Name, Memory, Dynamic Memory, vCPUs, VNC Console Password, add and remove disk storage, add network interfaces, and modify the boot order for the guest virtual machine. [Table 13–5](#) lists the guest virtual machine fields that can be edited and the action needed for the changes to take effect.

**Table 13–5 Guest Virtual Machines: Editable Fields**

Editable Field	Action for Changes to Take Effect
Virtual Machine Name	This field can be edited only for guest virtual machines in the Halted status. Changes will take effect when the guest virtual machine is started.
Memory	This field can be edited only for guest virtual machines in the Halted status. Changes will take effect immediately when the guest virtual machine is started.
Dynamic Memory	Dynamic memory specified should be lesser than or equal to the Memory specified. For para-virtualized guest virtual machines, changes to the memory take effect without stopping and starting the guest virtual machine. For hardware-virtualized guest virtual machines, changes to memory take effect only after stopping and starting the guest virtual machine.

**Table 13–5 (Cont.) Guest Virtual Machines: Editable Fields**

Editable Field	Action for Changes to Take Effect
Virtual CPUs	For para-virtualized guest virtual machines, number of virtual CPUs can be edited and changes take effect without stopping and starting the guest virtual machine. For hardware-virtualized guest virtual machines, changes to virtual CPUs take effect only after stopping and starting the guest virtual machine.  For Oracle VM of version 2.2 onwards, the number of virtual CPUs cannot be increased beyond the value when the virtual machine was last started.
VNC Console Password	New password takes effect after the guest virtual machine is stopped and restarted.
CPU Scheduling Priority	Specify the priority of a guest virtual machine to access the physical CPUs, while competing with other guest virtual machines on the same virtual server. Higher the priority, higher is the stake of the guest virtual machine in claiming CPU cycles.
CPU Cap (%)	Restricts the amount of physical CPU that a guest virtual machine can use. Use this to constrain guest virtual machine resource allocation.
Enable High Availability Mode	If High Availability was enabled during guest virtual machine creation, you can edit the guest virtual machine to enable or disable High Availability.
Add/Remove Disk Storage	Changes take place immediately. CDs cannot be attached with para-virtualized guest machines.
QoS Priority Class	You can enable the disk I/O priority by setting an appropriate QoS Priority Class. The priority class ranges from 0 to 7. The priority class 0 has the highest priority, and 7 the lowest.
Add/Remove/Edit Network Interface	If a guest VM is running, all the interfaces that are present on it since the last restart can be removed, but not edited. But the newly added interfaces can be edited or removed. Changes take place immediately. The primary network interface VIF0 cannot be removed.
Network Rate	Allows you to control the bandwidth granted to each virtual network interface in the running guest virtual machine.
Boot Order	Requires the guest virtual machine to be stopped and restarted. Boot Order cannot be set to CD for para-virtualized guest virtual machines.

## Migrating from Oracle VM Manager to Enterprise Manager

If you are using Oracle VM Manager to manage Oracle VM Servers, virtual machines, and resources, and want to move to Enterprise Manager to manage your Oracle VM systems, follow these steps:

1. Delete the virtual server from Oracle VM Manager. For information about deleting a virtual server from Oracle VM Manager, see *Oracle VM Manager User's Guide* available at [http://download.oracle.com/docs/cd/E15458\\_01/doc.22/e15444/toc.htm](http://download.oracle.com/docs/cd/E15458_01/doc.22/e15444/toc.htm).
2. Shutdown the virtual server.
3. Create virtual server pool in Enterprise Manager. For information about creating virtual server pools, see [Creating Virtual Server Pool](#).

4. Register virtual servers with the server pool. For information about registering virtual servers, see [Registering Virtual Servers](#).
5. Discover guest virtual machines. For information about discovering guest virtual machines, see chapter *Provisioning Virtualization Systems* in the *Enterprise Manager Administrator's Guide for Software and Server Provisioning and Patching*.



---

---

## Oracle Beehive Service Dashboard Metrics

This appendix details the Oracle Beehive Service Dashboard metrics.

### Oracle Beehive Metrics

[Table A-1](#) explains the Oracle Beehive Service Dashboard metrics collected by Enterprise Manager:

**Table A-1 Oracle Beehive Metrics**

<b>Service Name</b>	<b>Metric Type</b>	<b>Metric Label</b>	<b>Source - Test/Target Type</b>	<b>Source Metric Name</b>	<b>Description</b>
Client Service	Performance	Connect Time	Web Transaction	Connect Time (ms)	Oracle Beehive Zimbra client is a web-based client to access E-mail, Calendar, etc., Test for Zimbra client has been modeled as a web transaction. Enterprise Manager breaks down each transaction into individual phases. Performance metrics for each phase of the transaction can help you pinpoint the cause of a slow response time alert. Connect Time is the total time spent in the transaction connecting to the server. There may be multiple connections made during a transaction. Time spent waiting for requests that result in redirects count as Redirect Time rather than Connect Time.

**Table A-1 (Cont.) Oracle Beehive Metrics**

<b>Service Name</b>	<b>Metric Type</b>	<b>Metric Label</b>	<b>Source - Test/Target Type</b>	<b>Source Metric Name</b>	<b>Description</b>
Client Service	Performance	Perceived Time	Web Transaction	Perceived Time per Page (ms)	The average amount of time that it would take the beacon to play each page in the transaction. This is a good metric for setting thresholds because it is the closest active measurement of what the user-experience is likely to be. Because it is normalized on a per-page basis, Perceived Time per Page is also a good metric for comparing the relative performance of different transactions.
Conferencing Service	Usage	Conf Participants	Conference Application	Conference Participants	A Conference Session can have multiple participants. Conf Participants is the participants taking part in conference sessions at each collection.

**Table A-1 (Cont.) Oracle Beehive Metrics**

<b>Service Name</b>	<b>Metric Type</b>	<b>Metric Label</b>	<b>Source - Test/Target Type</b>	<b>Source Metric Name</b>	<b>Description</b>
Conferencing Service	Usage	Conf Sessions	Conference Application	Conference Sessions	Oracle Beehive provides online voice and Web conferencing enabling meeting organizers and participants to conduct collaborative sessions online through Oracle Beehive Conferencing. There can be multiple conference sessions in progress at the same time. Conf Sessions is the number of conference sessions active at each collection (current conference sessions).



**Table A-1 (Cont.) Oracle Beehive Metrics**

<b>Service Name</b>	<b>Metric Type</b>	<b>Metric Label</b>	<b>Source - Test/Target Type</b>	<b>Source Metric Name</b>	<b>Description</b>
Email Service	Performance	Email Read Time	IMAP Test	Time to Read Email (ms)	Oracle Beehive E-mail Service supports standard SMTP protocol to send an e-mail and IMAP protocol to read e-mails. Msg Delivery Time measures the round-trip time (in milliseconds) from when a sender sends an e-mail to when the same e-mail is received in the receiver's Inbox. It indicates the time taken to deliver an email. This is a SMTP service test metric and is collected only if the Calculate Message Delivery Time test parameter in SMTP test is set to Yes.
Email Service	Performance	IMAP Login Time	IMAP Test	Login Time (ms)	Oracle Beehive E-mail Service supports standard IMAP protocol to access e-mail. IMAP Login Time is the time taken (in milliseconds) to login to an IMAP Service.

**Table A-1 (Cont.) Oracle Beehive Metrics**

<b>Service Name</b>	<b>Metric Type</b>	<b>Metric Label</b>	<b>Source - Test/Target Type</b>	<b>Source Metric Name</b>	<b>Description</b>
Email Service	Performance	Msg Delivery Time	SMTP Test	Message Delivery Time (ms)	Oracle Beehive E-mail Service supports standard SMTP protocol to send an e-mail and IMAP protocol to read e-mails. Message Delivery Time measures the round-trip time (in milliseconds) from when a sender sends an e-mail to when the same e-mail is received in the receiver's Inbox. It indicates the time taken to deliver an email. This is a SMTP service test metric and is collected only if the Calculate Message Delivery Time test parameter in SMTP test is set to Yes.
Email Service	Usage	Emails Received	Email Application	Transport Mails Received	The number of e-mails received by the Oracle Beehive E-mail Service transport subsystem in a collection interval.
Email Service	Usage	IMAP Sessions	Email Application	Current IMAP Sessions	Number of E-mail Service IMAP sessions at each collection.

**Table A-1 (Cont.) Oracle Beehive Metrics**

<b>Service Name</b>	<b>Metric Type</b>	<b>Metric Label</b>	<b>Source - Test/Target Type</b>	<b>Source Metric Name</b>	<b>Description</b>
Email Service	Usage	SMTP Sessions	Email Application	Current Open SMTP Sessions	Number of E-mail service SMTP sessions at each collection.
FTP Service	Performance	Download Time	FTP Test	Download Time (ms)	The total time required to download a file using Oracle Beehive FTP service.
FTP Service	Performance	Login Time	FTP Test	Login Time (ms)	Oracle Beehive FTP Service supports all content management-related features, including download and upload, through FTP and FTP over TLS. Login Time is the time required to login to the Oracle Beehive FTP service.
FTP Service	Performance	Upload Time	FTP Test	Upload Time (ms)	The time required to upload a file to Oracle Beehive server using Oracle Beehive FTP service.
FTP Service	Usage	Files Downloaded	FTP Application	Downloaded Files	Number of files downloaded using Oracle Beehive FTP Service in a collection interval.
FTP Service	Usage	Files Uploaded	FTP Application	Uploaded Files	Number of files uploaded using Oracle Beehive FTP Service in a collection interval.

**Table A-1 (Cont.) Oracle Beehive Metrics**

<b>Service Name</b>	<b>Metric Type</b>	<b>Metric Label</b>	<b>Source - Test/Target Type</b>	<b>Source Metric Name</b>	<b>Description</b>
FTP Service	Usage	Users	FTP Application	User FTP Connections	Number of FTP connections in a collection interval.
Mobile Service	Performance	Login Time	PushMail Application	Avg Login Time	The Oracle Beehive Mobile Mail Service provides a complete Push IMAP (P-IMAP) v0.6 implementation for real-time delivery of e-mail to users' mobile devices. Avg Login Time is the average login time to login to Oracle Beehive PushMail service as measured in each collection interval.
Mobile Service	Usage	Emails Read	PushMail Application	Emails Marked Seen	Number of e-mail messages marked as seen in a collection interval that were accessed using Mobile Mail (PushMail) Service.
Mobile Service	Usage	Emails Sent	PushMail Application	Emails Sent	Number of e-mail messages sent in a collection interval using Mobile Mail (PushMail) Service.
Mobile Service	Usage	Users	PushMail Application	Current Server Usage	Number of users using Mobile Mail Service (PushMail) at each collection.

**Table A-1 (Cont.) Oracle Beehive Metrics**

<b>Service Name</b>	<b>Metric Type</b>	<b>Metric Label</b>	<b>Source - Test/Target Type</b>	<b>Source Metric Name</b>	<b>Description</b>
Presence and IM Service	Usage	Contact Listing Time	XMPP Test	Contacts Listing Time (ms)	Time taken (in milliseconds) to retrieve the roster of contacts from Oracle Beehive XMPP Service.
Presence and IM Service	Usage	Files Transferred	XMPP Application	File Transfers	Number of files transferred in a collection interval using Oracle Beehive XMPP Service.
Presence and IM Service	Usage	IM Sending Time	XMPP Test	Message Send Time (ms)	Time taken (in milliseconds) to send an instant message using Oracle Beehive XMPP Service.
Presence and IM Service	Usage	Messages Exchanged	XMPP Application	IM Messages Exchanged	Number of messages exchanged in a collection interval using Oracle Beehive XMPP Service.
Presence and IM Service	Usage	XMPP Login Time	XMPP Test	Login Time (ms)	Oracle Beehive XMPP Service supports Instant Messaging using standard XMPP protocol. XMPP Login Time is the time taken (in milliseconds) to login to the Oracle Beehive XMPP Service.
Presence and IM Service	Usage	XMPP Sessions	XMPP Application	Active XMPP Sessions	Number of active XMPP sessions running as measured in a collection interval.

**Table A-1 (Cont.) Oracle Beehive Metrics**

<b>Service Name</b>	<b>Metric Type</b>	<b>Metric Label</b>	<b>Source - Test/Target Type</b>	<b>Source Metric Name</b>	<b>Description</b>
Time Management Service	Performance	Add Meeting Time	CalDAV Test	Event Add Time (ms)	Time taken (in milliseconds) to add a calendar event using CalDAV Service.
Time Management Service	Performance	CalDAV Login Time	CalDAV Test	Calendar Access Verification Time (ms)	Oracle Beehive CalDAV and Time Management Services support all aspects of time and task management. CalDAV Login Time is the time taken (in milliseconds) to access and login to Oracle Beehive Calendar using CalDAV URL.
Time Management Service	Performance	Content Listing Time	CalDAV Test	Content Listing Time (ms)	Time taken (in milliseconds) to list the contents of the Calendar folder using Beehive CalDAV Service.
Time Management Service	Usage	Meetings Created	TimeManagement Application	Number of Create Meetings	Number of meetings created in Oracle Beehive Calendar in a collection interval.
Time Management Service	Usage	Meetings Searched	TimeManagement Application	Number of Search Meetings	Number of meetings searched in Oracle Beehive Calendar in a collection interval.

**Table A-1 (Cont.) Oracle Beehive Metrics**

<b>Service Name</b>	<b>Metric Type</b>	<b>Metric Label</b>	<b>Source - Test/Target Type</b>	<b>Source Metric Name</b>	<b>Description</b>
Time Management Service	Usage	Tasks Created	TimeManagement Application	Number of Create Tasks	Number of tasks created in Oracle Beehive Calendar in a collection interval.
User Directory Service	Performance	Create User Time	UserDirectory Application	Avg Create User Time	Oracle Beehive User Directory Service (UDS) provides comprehensive user and group management capabilities for Oracle Beehive. Create User Time is the average time taken to create a user in Oracle Beehive user directory as measured in a collection interval.
User Directory Service	Performance	Update AddrBook Time	UserDirectory Application	Avg Update Address Book Time	Average time taken to update an address book in Oracle Beehive user directory as measured in a collection interval.
User Directory Service	Performance	Update User Time	UserDirectory Application	Avg Update User Time	Average time taken to update a user in Beehive user directory as measured in a collection interval.
User Directory Service	Usage	AddrBooks Updated	UserDirectory Application	Number of Address Books Updated	Number of Oracle Beehive User Directory address books updated in a collection interval.

**Table A-1 (Cont.) Oracle Beehive Metrics**

<b>Service Name</b>	<b>Metric Type</b>	<b>Metric Label</b>	<b>Source - Test/Target Type</b>	<b>Source Metric Name</b>	<b>Description</b>
User Directory Service	Usage	Users Created	UserDirectory Application	Number of Users Created	Number of users created in Oracle Beehive User Directory in a collection interval.
User Directory Service	Usage	Users Updated	UserDirectory Application	Number of Users Updated	Number of users updated in Oracle Beehive User Directory in a collection interval.
Voice Message Service	Performance	Create VM Time	VoiceMessage Application	Avg Create Voice Message Time	Oracle Beehive Voice Message Service supports all aspects of voicemail and fax management for Oracle Beehive. Create VM Time is the average time taken to create a Voice Message using Oracle Beehive Voice Message Service as measured in a collection interval.
Voice Message Service	Performance	Delete VM Time	VoiceMessage Application	Avg Delete Voice Message Time	Average time taken to delete a Voice Message using Oracle Beehive Voice Message Service as measured in a collection interval.
Voice Message Service	Usage	VMs Created	VoiceMessage Application	Number of Create Voice Messages	Number of Oracle Beehive voice messages created in a collection interval.



**Table A-1 (Cont.) Oracle Beehive Metrics**

<b>Service Name</b>	<b>Metric Type</b>	<b>Metric Label</b>	<b>Source - Test/Target Type</b>	<b>Source Metric Name</b>	<b>Description</b>
Voice Message Service	Usage	VMs Deleted	VoiceMessage Application	Number of Delete Voice Messages	Number of voice messages deleted in a collection interval.
WebDAV Service	Performance	Connect Time	WebDAV Test	Connect Time (ms)	Oracle Beehive WebDAV Service supports all content management-related features, including download and upload, using the Web-based Distributed Authoring and Versioning (WebDAV) protocol. Connect Time is the time taken (in milliseconds) to connect to the Beehive WebDAV server.
WebDAV Service	Performance	File Creation Time	WebDAV Test	File Creation Time (ms)	Indicates time taken (in milliseconds) to create the file using Oracle Beehive WebDAV Service.
WebDAV Service	Performance	File Read Time	WebDAV Test	File Read Time (ms)	Indicates time taken (in milliseconds) to read the file from Beehive using WebDAV protocol.

**Table A-1 (Cont.) Oracle Beehive Metrics**

<b>Service Name</b>	<b>Metric Type</b>	<b>Metric Label</b>	<b>Source - Test/Target Type</b>	<b>Source Metric Name</b>	<b>Description</b>
WebDAV Service	Usage	Files Downloaded	WebDAV Application	Number of GET Commands	Number of GET commands executed using Oracle Beehive WebDAV Service in a collection interval.
WebDAV Service	Usage	Files Uploaded	WebDAV Application	Number of PUT Commands	Number of PUT commands executed using Oracle Beehive WebDAV Service in a collection interval.
WebDAV Service	Usage	Users	WebDAV Application	Number of Logins	Number of Logins operations performed to Oracle Beehive WebDAV Service in a collection interval.
Workspaces Service	Performance	Create Doc Time	Workspaces Application	Avg Create Document Time	Oracle Beehive Workspace Service supports all the features and functionality provided by Oracle Beehive personal and team workspaces. Create Doc Time is the average time taken to create a document in Oracle Beehive Workspace as measured in a collection interval.

**Table A-1 (Cont.) Oracle Beehive Metrics**

<b>Service Name</b>	<b>Metric Type</b>	<b>Metric Label</b>	<b>Source - Test/Target Type</b>	<b>Source Metric Name</b>	<b>Description</b>
Workspaces Service	Performance	Create Team Ws Time	Workspaces Application	Avg Create Team Workspace Time	Average time taken to create a team workspace in Oracle Beehive as measured in a collection interval.
Workspaces Service	Performance	Delete Doc Time	Workspaces Application	Avg Delete Document Time	Average time taken to delete a document in Oracle Beehive Workspace as measured in a collection interval.
Workspaces Service	Usage	Docs Created	Workspaces Application	Number of Create Documents	Number of documents created in Oracle Beehive Workspaces in a collection interval.
Workspaces Service	Usage	Docs Deleted	Workspaces Application	Number of Delete Documents	Number of documents deleted in Oracle Beehive Workspaces in a collection interval.
Workspaces Service	Usage	Team Ws Created	Workspaces Application	Number of Create Team Workspaces	Number of team workspaces created in Oracle Beehive in a collection interval.



---

---

# Glossary

## **adaptive alert thresholds**

Computed statistical alert thresholds using either static (user-defined) or dynamic (self-adjusting) baselines.

*See also* [metric baselines](#).

## **ADDM**

*See* [Automatic Database Diagnostic Monitor \(ADDM\)](#).

## **administrator account**

Enterprise Manager administrator account that provides permission to perform daily administration work and access administrative information.

## **agent**

*See* [Oracle Management Agent](#).

## **alert**

Indicator signifying a particular metric condition has been encountered. An alert is triggered when one of the following conditions is true:

- A metric threshold is reached.
- The availability of a monitored service changes. For example, the availability of the host changes from up to down.
- A metric-specific condition occurs. For example, an alert is triggered whenever an error message is written to a database alert log file.

## **Application Server Control**

Web-based management features designed to monitor and administer application server instances, farms, and clusters.

## **attestation**

Process of having users or system managers confirm people's access rights on a periodic basis.

## **Automatic Database Diagnostic Monitor (ADDM)**

Application that automatically takes regularly scheduled snapshots of the database activity. ADDM identifies the most resource-intensive components or operations and provides advice, which may recommend running an advisor or making configuration changes to your database.

### **Automatic Storage Management (ASM)**

Application that automates and simplifies the layout of data files, control files, and log files. Database files are automatically distributed across all available disks, and database storage is rebalanced whenever the storage configuration changes.

### **Automatic target discovery**

Process by which targets are located and added to Enterprise Manager. Automatic discovery begins when the Oracle Management Agent starts up after installation. Targets located on the Agent are discovered and added to Enterprise Manager to be monitored and administered. How the targets are installed determines which targets are automatically added.

### **Automatic Workload Repository (AWR)**

Automatic capture of statistics data for real-time and historical performance analysis. AWR includes snapshot data, active session history data, and workload reports.

### **availability**

The percentage or amount of scheduled time that a computing system provides application service.

### **AWR**

See [Automatic Workload Repository \(AWR\)](#).

### **Beacon**

Application to monitor transactions from different user communities or geographical regions. You can enable the Beacon software to monitor the availability and performance of network components (a host computer or an IP traffic controller) from more than one location, or Web pages and Web applications from multiple network locations.

### **blackout**

Maintenance tool for suspending any data collection activity on one or more monitored targets. This allows you to perform scheduled maintenance on targets while excluding these special-case situations from the data analysis to obtain a more accurate, long-term picture of a target's performance.

### **cluster cache coherency**

For Oracle Real Application Clusters (RAC) environments, helps you identify processing trends and optimize performance. The Cluster Cache Coherency page enables you to view the global cache block access latency, global cache block transfer rate, and global cache block transfers and physical reads.

### **control**

See [Oracle Enterprise Manager 10g Grid Control](#), [Oracle Enterprise Manager 10g Database Control](#), [Oracle Enterprise Manager 11g Fusion Middleware Control](#), [Oracle Enterprise Manager 10g Application Server Control for Collaboration Suite](#).

### **dashboard**

Tool for proactively monitoring status and alerts as they occur by viewing the health of managed targets in real time. The dashboard presents information using intuitive icons and graphics that let you spot recent changes and quickly identify and respond to problems.

**database configuration**

The configuration information Enterprise Manager collects for an Oracle database, which includes:

- General database and instance information, such as the database name, instance name, and whether or not the database is running in restricted mode or archive log mode
- Initialization parameter values
- System Global Area values
- Tablespaces and their parameters
- Datafiles and their parameters
- Control files and their attributes
- Redo logs and their attributes
- Rollback segments and their parameters
- High availability information
- License information
- Database options information

**database instance**

Running Oracle Database consisting of memory structures (SGA) and background processes. An instance only exists while it is up and running. Essentially, a database resides on disk, while an instance resides in memory.

A database is normally managed by only one instance. However, when using Oracle Real Application Clusters, multiple instances can be started for a single database (on different hosts of a cluster).

*See also* [Oracle Real Application Clusters \(RAC\)](#).

**enterprise configuration**

Configuration information stored in the Management Repository for the set of hosts and targets that comprise your enterprise.

**fast-start failover**

Ability of Data Guard to rapidly and automatically fail over to a standby database without requiring manual intervention. This improves the degree of availability as well as the disaster resilience for the system infrastructure.

**fetchlet**

Parameterized data access mechanism that takes arguments for input and returns formatted data.

**Grid Control console**

*See* [Oracle Enterprise Manager 10g Grid Control console](#).

**group**

Single logical unit that can include targets of the same type (for example, all your production databases) or include targets of different types (for example, all targets comprising your business's application). Groups enable you to enable you to collectively monitor and administer many targets.

### **home page**

See [target home page](#).

### **host configuration**

Configuration information that Enterprise Manager collects for a host that is a managed target, including:

- Hardware for the host (including memory, CPU, I/O device, and network interface information)
- Operating system for the host (including information such as operating system properties, packages, and installed patches)
- Installed Oracle software, including (but not limited to) installed products and their components, patch sets, and interim patches on the host. Enterprise Manager uses the Oracle Universal Installer inventory or inventories on a host to obtain information about the Oracle products installed on the host.

### **instance**

See [database instance](#).

### **Java EE**

Abbreviation for Java 2 Platform Enterprise Edition. Java EE is an environment for developing and deploying enterprise applications.

### **Management Agent**

See [Oracle Management Agent](#).

### **Management Plug-in**

See [Oracle Management Plug-in](#).

### **Management Repository**

See [Oracle Management Repository](#).

### **Management Services**

See [Oracle Management Service](#).

### **metric**

Unit of measurement used to report the health of the system.

### **metric baselines**

Named period of time associated with a target and used as a reference for evaluating target performance. Statistics are computed over the baseline period for specific target metrics. You can use these statistics to automatically set metric thresholds for alerting, as well as to normalize graphical displays of system performance.

See also [adaptive alert thresholds](#).

### **metric snapshot**

Named collection of a target's performance metrics that have been collected at a specific point in time. A metric snapshot can be used as an aid in calculating metric threshold values based on the target's past performance.



**Notification Methods**

Mechanism for defining different mechanisms for sending notifications. These include e-mail, SNMP traps, or running custom scripts—or all three. Once defined, these methods can then be used with Notification Rules for sending notifications to administrators as a result of alert occurrences.

**Oracle ecosystem**

Organization of software, hardware, and their environment so that they function as a unit. Typically, this consists of an Oracle platform and all third-party software, including storage systems, hosts, routers, and so on. The Grid Control Home page provides a unified view of your ecosystem.

**Oracle Enterprise Manager 11g**

Oracle Enterprise Manager is the Oracle integrated management solution for managing your computing environment.

**Oracle Enterprise Manager 11g Fusion Middleware Control**

Fusion Middleware Control relies on various underlying technologies to discover, monitor, and administer the Oracle Fusion Middleware environment. Fusion Middleware Control consists of the Fusion Middleware Control console and its underlying technologies:

- Oracle Dynamic Monitoring Service (DMS)
- Oracle Process Management Notification (OPMN)
- Distributed Configuration Management (DCM)
- A local version of the Oracle Management Agent specifically designed to gather monitoring data for Fusion Middleware Control.

**Oracle Enterprise Manager 10g Application Server Control console**

The Enterprise Manager Web-based user interface for managing Oracle Application Server 10g. The Application Server Control console is installed and available with every Application Server 10g installation.

From the Application Server Control console, you can monitor and administer a single Oracle Application Server instance, a farm of Oracle Application Server instances, or Oracle Application Server Clusters.

**Oracle Enterprise Manager 10g Application Server Control for Collaboration Suite**

Application Server Control for Collaboration Suite consists of a Web-based user interface and a set of underlying technologies. Oracle Enterprise Manager 10g Application Server Control for Collaboration Suite is installed and available with every Collaboration Suite installation.

**Oracle Enterprise Manager 10g Application Server Control Console for Collaboration Suite**

The Enterprise Manager Web-based user interface for managing Oracle Collaboration Suite. The Application Server Control for Collaboration Suite console is installed and available with every Oracle Collaboration Suite installation. From this console, you can monitor and administer a single Oracle Collaboration Suite instance.

### **Oracle Enterprise Manager 10g Database Control**

Database Control relies on various underlying technologies to discover, monitor, and administer the Oracle Database environment.

Database Control consists of the Database Control console and its underlying technologies:

- A local version of the Oracle Management Service designed to work with the local database or clustered database
- A local Oracle Management Repository installed in the local database and designed to store management data for the Database Control console
- A local version of the Oracle Management Agent designed to provide monitoring data to the local Management Service

### **Oracle Enterprise Manager 10g Database Control console**

The Enterprise Manager Web-based user interface for managing Oracle Database 10g. The Database Control console is installed and available with every Oracle Database 10g installation.

From the Database Control console, you can monitor and administer a single Oracle Database instance or a clustered database.

### **Oracle Enterprise Manager 10g Grid Control**

Grid Control relies on various underlying technologies to discover, monitor, and administer your computing environment. Grid Control consists of the Grid Control console and these underlying technologies:

- One or more Oracle Management Services
- The Oracle Management Repository
- The central Management Agent
- Remote Oracle Management Agents, installed on each monitored host

### **Oracle Enterprise Manager 10g Grid Control console**

Enterprise Manager Web-based user interface for centrally managing your entire computing environment.

From the Grid Control console, you can monitor and administer your entire computing environment from one location on the network. All the services within your enterprise, including hosts, databases, listeners, application servers, HTTP Servers, and Web applications, are easily managed as one cohesive unit.

### **Oracle Management Agent**

A process deployed on each monitored host. The Oracle Management Agent is responsible for monitoring all targets on the host, for communicating that information to the middle-tier Management Service, and for managing and maintaining the host and its targets.

### **Oracle Management Plug-in**

Target type provided by the user or a third party to extend Enterprise Manager's set of predefined target types.

### **Oracle Management Repository**

Two tablespaces in an Oracle Database that contain information about administrators, targets, and applications that are managed within Enterprise Manager.

The Management Service uploads to the Management Repository the monitoring data it receives from the Management Agent. The Management Repository then organizes the data so it can be retrieved by the Management Service and displayed on Grid Control.

**Oracle Management Service**

A J2EE Web application that renders the user interface for the Grid Control console, works with all Management Agents in processing monitoring and job information, and uses the Management Repository as its data store.

**My Oracle Support**

Oracle Support Services site where customers can get information about released patches and outstanding bugs. You can use Enterprise Manager to download patches from *My Oracle Support*.

**Oracle Streams**

Propagation and management of data, transactions, and events in a data stream either within a database, or from one database to another. Controls what information is put into a stream, how the stream flows from database to database, what happens to messages in the stream, and how the stream terminates.

**policy**

Defines the desired behavior of systems and is associated with one or more targets or groups. Policies include different categories of policy rules, such as configuration, security, and storage rules. Enterprise Manager compares the targets for which policy rules exist with the policy rules for that target type, and identifies the policy violations for the target.

**policy association**

Relationship of a policy rule and its settings to a target or monitoring template.

**policy compliance score**

Number denoting the conformance of a target to a set of requirements (policy rules.) The score, ranging from 0% to 100%, is much like a test score. A score of 100% means that the target was fully compliant with the goals of the policy. The policy compliance score facilitates your assessment of the relative levels of attention needed for various targets given the violations on those targets.

**policy evaluation**

Process of testing a policy's condition and recording any violations in the repository.

**policy groups**

Standards that report deviations and enable closed loop remediation by optionally taking action to bring systems back into compliance.

**policy rule**

A conditional expression that tests values from a target against a condition; for example, verifying that database profile limits are set as expected.

**policy rule library**

Collection of policy rules.

**policy settings**

Conditions related to a policy. The policy settings include, but are not limited to, parameter values and excluded objects.

**policy trend**

The policy compliance trend of a policy in the domain of a particular target.

**policy violation**

Infringement of a policy rule. For example, one of the host security policy rules checks for open ports. The recommendation is that the insecure ports not be opened. Therefore, the violation is that there are open ports.

**privileges**

A right to perform management actions within Enterprise Manager, such as view any target and add any target in the enterprise, or a right to perform operations on a target such as maintaining and cloning the target. Types of privileges are defined by Oracle.

**Oracle Real Application Clusters (RAC)**

Option that allows multiple concurrent instances to share a single physical database. It provides a high-availability database environment spanning multiple hosts. Each cluster can be comprised of multiple cluster databases, each of which consists of multiple cluster database instances.

**redundancy group**

Group that contains members of the same type that function collectively as a unit.

**repository**

See [Oracle Management Repository](#).

**roles**

Collection of predefined Enterprise Manager target or system privileges created by super administrators to facilitate granting multiple privileges or roles to users. Roles limit target access and access to specific management features.

**Secure Socket Layer (SSL)**

Software to secure the communications between the Management Service and the Management Agent. Encrypted communications between the Management Agent and Management Service over HTTPS ensures the privacy of data sent from one computer to another.

**service**

Entity that provides a useful function to its users, such as CRM applications, online banking, and email services. Some simpler forms of services are business functions that are supported by protocols such as DNS, LDAP, POP, or SMTP.

**standby database**

Read-only database on the standby node. The standby database, also referred to as the replicated database, is physically identical to the master database. In the event of catastrophic failures, data modification activities “fail over” to the standby database so that it becomes the new master database.

**Super Administrator**

Enterprise Manager administrator that can create, modify, and delete any Enterprise Manager administrator, create any role in the system, perform any action on any target in the system, and see all areas of the management system.

**SYSMAN**

By default during the installation of Oracle Enterprise Manager, one Super Administrator account is created with the user name of SYSMAN. The SYSMAN account should be used to perform infrequent system-wide, global configuration tasks such as setting up the environment. Other administrator accounts can be created for daily administration work. The SYSMAN account is:

- Owner of the Management Repository schema
- Default Enterprise Manager Super Administrator
- User name used to log in to Enterprise Manager the first time

**system**

Logical grouping of targets that collectively hosts one or more services. It is a set of infrastructure targets (hosts, databases, application servers, and so on) that function together to host one or more applications or services.

**system privilege**

Allows a user to perform system-wide operations. For example, the VIEW ANY TARGET system privilege allows the administrator to view any target on the system, including Oracle Management Agents and Oracle Management Services.

**target**

A single component that you can monitor or configure with Enterprise Manager. Examples of a target include:

- Single Oracle 10g database
- Group of databases that provide your worldwide customers with product information
- Oracle Application Server or an instance of Oracle HTTP Server
- Web application that your customers visit to investigate or buy your products
- Linux host computer, including its memory, disks, and CPU
- Server load balancer switch that controls the Internet traffic for a set of Web servers

Enterprise Manager can manage all these targets. A complete list of the target types you can manage is included in *Oracle Enterprise Manager Grid Control Installation and Basic Configuration*.

**target compliance score**

Average of the individual policy compliance scores for policies that have been associated with a target. Also, a target's security compliance score is the average of the compliance scores for security policies associated with that target.

You can use a compliance score to assess a target's overall compliance, and a group can use a score to determine the most troubled targets with respect to policy violations.

**target home page**

Page that contains general information about the selected target. From a target home page, you can drill down for more detailed performance information.

**target privilege**

Privilege that allows an administrator to perform operations on a target. For example, the View Target privilege allows an administrator to view properties, inventory, and monitor information about a target.

**threshold**

Boundary values against which monitored metric values are compared. The comparison determines whether an alert should be generated.

**topology**

Graphically shows the relationships between components, nodes, or objects within different Oracle applications.

**wait classes**

Grouping of wait events. Whenever an Oracle process waits for something, it records the wait using one of a set of predefined wait events. These wait events are grouped in wait classes, which show how much of the database is waiting for CPU time. The wait classes appear in the Database Performance page.

---

---

# Index

## A

---

accessing configuration pages, 4-8  
Active Session History (ASH), databases, 6-6  
Active Sessions Waiting page, picture of, 6-6  
ADDM, 3-4  
    purpose of, 3-4  
    using, 6-11  
    viewing findings, 6-11  
administering  
    databases, 6-16  
    hosts, 5-9  
    Linux hosts, 5-9  
administrators  
    defining rules, 2-4  
    responsibilities today, 2-3  
Advisor Central Home page, 6-22  
advisors  
    database administration, 6-21  
    invoking, 6-21  
    versus alerts, 6-22  
Aggregate Service service type, 8-2  
alerts  
    Collaboration Suite, 10-5  
    initiating with AWR, 6-3  
    server-generated, 3-4  
    services, 8-9  
    versus advisors, 6-22  
application database administrator, role of in data  
    masking, 6-25  
Application Server  
    analyzing historical performance, 9-10  
    extensible monitoring, 9-12  
    managing configurations, 9-19  
applying critical patches, 12-10  
automated  
    RAC deployments, picture of, 2-5  
Automatic Database Diagnostic (ADDM) page,  
    picture of, 6-11  
Automatic Database Diagnostic Monitor  
    *See* ADDM

automatic restarts, RAC, 6-48  
Automatic Storage Management (ASM), 6-17  
Automatic Workload Repository (AWR)  
    databases and, 6-3  
availability  
    definition, 8-2  
    diagnosing Collaboration Suite problems, 10-5  
    in services, 8-2  
    of a service, 8-2  
    services dashboard, 8-7  
Average Active Sessions chart, databases, 6-4, 6-5  
AWR baselines, 6-15

## B

---

backing up  
    databases, 6-41  
    logical database objects, 6-43  
backup settings, 6-42  
baselines  
    AWR, 6-15  
    change management and, 6-21  
    services and, 8-9  
BEA WebLogic, 5-11  
Beacons  
    Collaboration Suite, 10-4  
    services and, 8-2  
benefits of  
    Oracle Grid, 2-1  
    Oracle Grid Control, 2-1  
BIG-IP  
    *see* load balancer switches  
blocking sessions, hang analysis feature, 6-16  
business metrics, services and, 8-3

## C

---

change management, 6-21  
Client Configuration Collection Tag, 4-8  
client configurations, 4-7  
Client System Analyzer (CSA)  
    client configurations, 4-7  
    deployed independently, 4-7  
    in Grid Control, 4-7  
cloning  
    databases, 6-44

- production database in data masking, 6-27
- Cluster Cache Coherency page, picture of, 6-47
- cluster cache coherency, RAC, 6-46
- cluster interconnects, 6-47
- Cluster Interconnects page, picture of, 6-48
- Collaboration Suite
  - diagnosing problems, 10-5
  - Grid Control features for use with, 10-6
  - monitoring and alerts, 10-5
  - monitoring services, 10-4
  - Root Cause Analysis, 10-5
- collected configurations for targets, 4-1
- comparing configurations, 4-4, 6-45
- configuration pages, accessing in Grid Control, 4-8
- configurations
  - client, 4-7
  - Client System Analyzer (CSA), 4-7
  - comparing, 4-4, 6-45
  - features, databases, 6-17
  - hardware and software, 4-1
  - managing, 9-19
  - searching an enterprise, 4-5
  - using database configuration features, 6-17
  - viewing for an enterprise, 4-5
- configuring
  - collected configurations for targets, 4-1
  - hardware and software, 4-1
  - software, reducing time with provisioning tools, 2-4
- controlling distribution of resources, 6-18
- converting
  - dictionary-managed tablespace, 6-18
  - single instances to RAC, 6-18
- crash recovery, 6-42
- Create Service page, picture of, 6-49
- creating
  - database forms, 8-11
  - masking definition, 6-26
  - systems, 8-4, 8-5
- critical patch advisories, 12-8
  - managing, 12-9
  - providing, 6-45
- Critical Patch Facility, 12-7
- Critical Patch metadata, downloading, 12-10

## D

---

- dashboard
  - services, 8-6
- Data Guard, overview of, 6-43
- data masking
  - Add Columns page, 6-34
  - Add Dependent Columns page, 6-37
  - adding columns to a masking definition, 6-29
  - application database administrator, role of, 6-25
  - Canadian social insurance numbers, 6-32
  - cloning the production database, 6-27, 6-37
  - Create Masking Definition page, 6-34
  - creating masking definition, 6-26
  - Data Masking Definitions page, 6-34

- Define Column Mask page, 6-35, 6-39
- Define Group Mask page, 6-36
- defining new formats, 6-29
- description, 6-25
- DM\_FMTLIB package, installing, 6-32
- exporting and importing definitions, 6-40
- information security administrator, role of, 6-25
- ISBN numbers, 6-31
- major task steps, 6-27
- mask format libraries, description of, 6-26
- masking definitions, description of, 6-26
- masking format templates, using, 6-30
- North American phone numbers, 6-32
- other Oracle security products, 6-40
- patterns of format definitions, 6-30
- post-processing functions, 6-30
- predefined masking formats, using, 6-30
- primary key, 6-26
- recommended workflow, 6-26
- Script Generation Results page, 6-36
- security administrator, 6-26
- social security numbers, 6-31
- staging region, 6-26
- UPC numbers, 6-31
- use cases, 6-39
- user-defined functions, 6-29
- workflow, 6-26

- data, hiding with data masking, 6-25
- Database Control and Grid Control, comparisons of, 6-1
- Database Home page
  - features and information shown, 6-2
  - picture of, 6-3
- Database Performance page, picture of, 6-4
- Database Resource Manager, 6-18
- databases
  - Active Session History (ASH), 6-6
  - ADDM, 6-11
  - administering, 6-16
  - administration, 6-16
  - advisors, 6-21
  - Automatic Storage Management (ASM), 6-17
  - Average Active Sessions chart, 6-4, 6-5
  - AWR baselines, 6-15
  - backing up, 6-41
  - backup and recovery settings, 6-42
  - change management, 6-21
  - cloning, 6-44
  - converting dictionary-managed tablespace, 6-18
  - converting single instance to RAC, 6-18
  - Data Guard overview, 6-43
  - Database Resource Manager, 6-18
  - diagnosing performance problems
    - automatically, 6-11
  - Export to Files feature, 6-43
  - flashback recovery, 6-42
  - hang analysis feature, 6-16
  - historical SQL, 6-13
  - home page, 6-2
  - Home Page capabilities, 6-2



- Host Average Runnable Processes chart, 6-5
- Import from Database feature, 6-44
- indexes and data retrieval, 6-19
- instance activity, 6-12
- I/O charts, 6-5
- Load Data from File feature, 6-44
- maintaining, 6-41
- management, introduction, 6-1
- managing
  - materialized views, 6-20
  - objects, 6-19
  - restore points, 6-43
  - users and privileges, 6-20, 6-22
- Memory Access Mode, 6-16
- Monitor Export and Import Job feature, 6-44
- monitoring, 6-3
- optimizing performance, 6-17
- Oracle Streams, 6-44
- Parallel Execution charts, 6-5
- patching software, 6-45
- recovery, 6-41
- Recovery Manager (RMAN), 6-41
- scheduling jobs, 6-18
- schemas, working with, 6-19
- Segment Advisor, 6-19
- Services chart, 6-5
- services, cluster-managed, 6-48
- session details, viewing, 6-7
- software patching, 6-45
- SQL details, viewing, 6-7
- Throughput charts, 6-5
- top activity, viewing, 6-8
- top consumers of system resources, 6-12
- Topology Viewer, 6-14
- tracking statistics to improve performance, 6-18
- transporting tablespaces, 6-44
- using configuration features, 6-17
- views, 6-19
- wait class drill-downs, 6-6
- XML features, 6-19
- Dell PowerEdge Linux hosts, 5-7
- deploying software, reducing time with provisioning tools, 2-4
- deployments
  - applying critical patches, 12-10
  - Client Configuration Collection Tag, 4-8
  - Client System Analyzer (CSA), 4-7
  - Critical Patch Facility, 12-7
  - Linux host patching, 12-10
  - Management Repository, 4-1
  - managing critical patch advisories, 12-9
  - managing for hosts, 5-11
  - patching, 12-6
  - patching Oracle software, 12-8
- diagnosing
  - Collaboration Suite problems, 10-5
  - performance problems automatically, 6-11
  - performance problems interactively, 6-6
  - service problems, 8-12
  - slow or hung systems, 6-16

- dictionary baseline, 6-21
- dictionary-managed tablespace, converting, 6-18
- directory monitoring, 5-7
- documentation, getting from OTN, 3-4
- downloading Critical Patch metadata, 12-10

## E

---

- EMC SMARTS integration with Grid Control, 2-7
- emergency patching, 12-12
- enterprise configuration, 4-5
  - hardware, 4-5
  - predefined searches, 4-6
  - searching, 4-5
  - user-defined searches, 4-6
  - viewing, 4-5
- Execute Host Command page, description of, 5-10
- Export to Files feature, 6-43
- exporting files, 6-43
- extending Enterprise Manager
  - lifecycle stages for plug-ins, 3-7
- extensible monitoring, 9-12

## F

---

- F5
  - see* load balancer switches
- figures
  - Active Sessions Waiting Page, 6-6
  - Automated RAC Deployments and Extensions, 2-5
  - Cluster Cache Coherency Page, 6-47
  - Cluster Interconnects Page, 6-48
  - Consolidated Dashboard View of Multiple Services, 8-7
  - Create Service Page, 6-49
  - Database Home Page, 6-3
  - Database Performance Page, 6-4
  - Host Configuration Page, 4-4
  - Host Hardware Details Page, 5-6
  - Host Home Page, 5-3
  - Host Operating System Details Page, 5-5
  - Host Performance Page, 5-4
  - Host Storage Details Page, 5-9
  - Searching for Patches, 2-6
  - Service Topology Page, 8-9
  - System Home Page, 8-6
  - System Topology Page, 8-8
  - Topology for SQL Details Plan, 6-15
- file monitoring, 5-7
- flashback recovery, 6-42
- forms transactions, 8-11

## G

---

- Generic Service service type, 8-2
- Grid Control
  - ability to eliminate costs and errors, 2-3
  - accessing configuration pages, 4-8
  - administrators and, 2-4
  - Client System Analyzer, 4-7

- compared with Database Control, 6-1
- console, definition of, 3-3
- leveraging for Collaboration Suite, 10-6
- log file monitoring, 5-6
- lower management costs and, 2-3
- managing host deployments, 5-11
- monitoring hosts, 5-2
- third-party management, 5-11

Guaranteed Restore Point, 6-43

guest virtual machine, 13-3

guest VM server, 13-3

## H

---

hang analysis, for hung systems, 6-16

hardware

- configuration, collecting information, 4-1
- enterprise configuration, 4-5
- monitoring, Dell PowerEdge, 5-7

hiding data using data masking, 6-25

High Availability Oracle Clusterware, 6-50

historical SQL, databases, 6-13

Host Average Runnable Processes chart,

- databases, 6-5

Host Configuration page

- description of, 5-4
- picture of, 4-4

Host Hardware Details page

- description of, 5-5
- picture of, 5-6

Host Home page

- description of, 5-2
- picture of, 5-3

host management feature, 5-1

Host Operating System Details page

- picture of, 5-5

Host Performance page

- description of, 5-3
- picture of, 5-4

Host Storage Details page

- description of, 5-8
- picture of, 5-9

hosts

- administration, 5-9
- Dell PowerEdge Linux, 5-7
- Execute Host Command page, description of, 5-10
- executing host commands remotely, 5-10
- Host Configuration page
  - description of, 5-4
- Host Hardware Details page
  - description of, 5-5
- Host Home page, description of, 5-2
- Host Performance page, 5-3
- Host Storage Details page, description of, 5-8
- Linux host patching, 12-10
- Linux hosts administration, 5-9
- managing deployments, 5-11
- monitoring, 5-2
- Operating System Details page

- description of, 5-4
- Program Resource Utilization page, 5-6
- Remote File Editor page, 5-10
- remote host target, 5-10
- running operating system commands for, 5-10
- storage resource tracking, 5-8

HP OpenView Operations integration with Grid Control, 2-7

## I

---

IBM WebSphere, 5-11

Import from Database feature, 6-44

importing files, 6-44

indexes, data retrieval performance and, 6-19

Information Publisher

- patches and, 12-8

information security administrator, role of in data masking, 6-25

installing software, reducing time with provisioning tools, 2-4

instance activity, databases, 6-12

integration with non-Oracle solutions, 2-7

I/O charts, databases, 6-5

IP traffic controllers, 5-13

IT infrastructure performance, 2-1

## J

---

Java EE application responsiveness, monitoring, 9-9

JBoss, 5-11

Job System for hosts, 5-10

jobs

- Job System for hosts, 5-10
- predefined tasks, 3-6
- purpose of, 3-5
- scheduling, 6-18

## L

---

Linux

- host patching, 12-10
- host patching groups, 12-12

load balancer switches

- F5 Networks, 5-14
- F5 server load balancers, extensions of, 2-6

Load Data from File feature, 6-44

log file monitoring, 5-6

## M

---

maintaining databases, 6-41

- backups, 6-41
- Data Guard, 6-43
- flashback recovery, 6-42
- managing restore points, 6-43
- recovery, 6-41

management

- third-party, 5-11

Management Plug-ins

- introduction, 2-6

- Management Repository, 4-1
  - deployments and, 4-1
- managing
  - backups, 6-41
  - configurations, 9-19
  - critical patch advisories, 12-9
  - database objects, 6-19
  - databases, Home page, 6-2
  - hosts, 5-1
  - materialized views, 6-20
  - patches, 2-5
  - restore points, 6-43
  - storage objects, 6-17
  - systems, 8-4
  - third-party targets, 5-11
  - users and privileges, 6-20, 6-22
- mask format libraries, 6-26
- masking definitions, 6-26
  - credit card numbers, 6-31
- master server, 13-2
- materialized views, managing, 6-20
- media recovery, 6-42
- Memory Access Mode, performance issues and, 6-16
- metrics
  - AWR baselines, 6-15
  - performance and usage of services, 8-3
- Micromuse integration with Grid Control, 2-7
- Middleware
  - management, 9-1
- modeling business applications using services, 8-2
- Monitor Export and Import Job feature, 6-44
- monitoring
  - business applications using services, 8-2
  - Collaboration Suite, 10-5
  - databases, 6-3
  - end-user performance, 8-11
  - extensible, Application Server, 9-12
  - files and directories, 5-7
  - hardware for Dell PowerEdge systems, 5-7
  - hosts, 5-2
  - log files, 5-6
  - Program Resource Utilization page, 5-6
  - RAC, 6-46
  - services, 8-6
  - services for Collaboration Suite, 10-4
  - systems, 8-5
  - templates for services, 8-4
  - Web application services, 8-10
- Monitoring Templates feature
  - for services, 8-4

## N

---

- NetApp Filers
  - extensions of, 2-6
- Network Appliance Filer, 5-13
- notifications services, 8-9

## O

---

- object privileges, 6-20, 6-22
- objects
  - dictionary baseline, 6-21
  - managing, 6-19
- offline patching, 12-8
- online patching, 12-8
- Operating System Details page, description of, 5-4
- optimizing
  - database performance, 6-17
  - performance in RAC, 6-46
- Oracle
  - Application Server
    - historical performance, 9-10
    - Web Cache, 9-9
  - Clusterware, 6-50
  - Clusterware Registry, 6-50
  - Grid Control, benefits of, 2-1
  - home credentials, patching and, 12-9
  - Management Agent, configurations and, 6-45
  - patching software, 12-8
  - Streams, overview of, 6-44
  - Technology Network (OTN), 3-4
- Oracle Forms, 8-11
- Oracle Grid Control
  - See Grid Control
- Oracle HTTP Server session volumes, 9-9
- Oracle VM, 13-2
- OTN and documentation, 3-4

## P

---

- Parallel execution charts, databases, 6-5
- patch
  - management, 2-5
- patches, searching for, 2-6
- patching
  - applying critical patches, 12-10
  - compliance, 12-12
  - Critical Patch Facility, 12-7
  - deployment, 12-6
  - emergency, 12-12
  - information publisher, 12-8
  - Linux host patching groups, 12-12
  - Linux hosts, 12-10
  - offline, 12-8
  - online, 12-8
  - Oracle home credentials, 12-9
  - Oracle software, 12-8
  - setup, 12-8
  - shared agent patching, 12-9
  - software, 6-45
  - standalone database patching, 12-8
  - undoing, 12-12
  - validation, 12-9
- performance
  - ADDM, 6-11
  - analyzing historical, 9-10
  - AWR baselines, 6-15
  - charts for services, 8-9

- diagnosing Collaboration Suite problems, 10-5
- diagnosing problems
  - automatically, 6-11
  - interactively, 6-6
- for services, 8-2
- hang analysis feature, 6-16
- historical SQL, 6-13
- Host Performance page, description of, 5-3
- increasing with indexes, 6-19
- instance activity, 6-12
- Memory Access Mode, 6-16
- metrics, services and, 8-3
- optimizing, 6-17
- optimizing in RAC, 6-46
- Oracle Application Server, historical, 9-10
- service management and, 8-3
- services dashboard, 8-7
- session details, viewing, 6-7
- SQL details, viewing, 6-7
- top activity, viewing, 6-8
- top consumers of system resources, 6-12
- tracking statistics, 6-18
- wait class drill-downs, 6-6
- post-processing functions, data masking and, 6-30
- predefined
  - job tasks, 3-6
  - searches, enterprise configuration, 4-6
- primary key, data masking and, 6-26
- privileges
  - managing for users, 6-20, 6-22
  - Show Grantees function, 6-20, 6-22
- provisioning Oracle VM, 13-22

## R

---

### RAC

- adding cluster hosts for efficiency, 6-46
- automatic restart of key components, 6-48
- cluster cache coherency, 6-46
- cluster interconnects, 6-47
- cluster-managed database services, 6-48
- converting single instances to RAC, 6-18
- interconnects, 6-47
- monitoring, 6-46
- optimizing performance, 6-46
- Oracle Clusterware, 6-50
- Oracle Clusterware Registry, 6-50
- purpose of, 6-46
- tasks, 6-46
- viewing current state of interfaces, 6-47
- Voting Disk, 6-50
- Real Application Clusters
  - See RAC
- recovery
  - flashback, 6-42
  - settings, 6-42
  - types of, 6-41
- Recovery Manager (RMAN), for backups, 6-41
- regulatory compliance using masked data, 6-25
- Remote File Editor page, 5-10

- remote host target, 5-10
- reports
  - for services, 8-9
- resource tracking, storage, 5-8
- restarts, RAC, 6-48
- restore points, managing, 6-43
- Right to Financial Privacy Act of 1978, 6-25
- Root Cause Analysis
  - Collaboration Suite, 10-5
  - for services, 8-2, 8-12
  - service failure and, 8-8
  - Topology Viewer, 8-12
- running operating system commands, 5-10

## S

---

- Sarbanes-Oxley requirements, 6-25
- scheduling jobs, 6-18
- schemas
  - objects, materialized views, 6-20
  - working with, 6-19
- searching
  - enterprise configuration, 4-5
  - for patches, picture of, 2-6
- security
  - compliance with masked data, 6-25
  - data masking, 6-25
  - list of Oracle products, 6-40
  - mask format libraries, 6-26
  - masking definitions, 6-26
  - security administrator, data masking and, 6-26
- Segment Advisor, for managing databases, 6-19
- server-generated alerts, 3-4
- Service Level Management feature, 8-4
- service test, 8-2
- Service Topology page, picture of, 8-8
- service types
  - Aggregate Service, 8-2
  - Generic Service, 8-2
  - Web Application, 8-2
- service, definition of, 8-1
- service-level agreements, 8-1
- services, 8-2
  - alerts, 8-9
  - availability of, 8-2
  - baselines, 8-9
  - Beacons, 8-2
  - business metrics, 8-3
  - cluster-managed database services, 6-48
  - dashboard, 8-6
  - diagnosing problems, 8-12
  - failure and Root Cause Analysis, 8-12
  - forms and, 8-11
  - forms transactions, 8-11
  - introduction, 8-1
  - key Beacons, 8-3
  - key components, 8-3
  - key tests, 8-3
  - monitoring, 8-6
  - monitoring for Collaboration Suite, 10-4

- Monitoring Templates feature, 8-4
- monitoring templates for, 8-4
- monitoring Web applications, Web application services, monitoring, 8-10
- notifications, 8-9
- performance and usage, 8-3
- performance definition, 8-2
- performance metrics, 8-3
- performance of in charts, 8-9
- reports for, 8-9
- Root Cause Analysis, 8-12
- Root Cause Analysis tool, 8-2
- service level agreements, 8-1
- service level definition, 8-2
- Service Level Management feature, 8-4
- service test, 8-2
- service test-based availability, 8-3
- Service Topology page, 8-8
- setting service-level rules, 8-4
- system-based availability, 8-3
- Topology Viewer, 8-5
- transactions and, 8-10
- usage definition, 8-2
- usage metrics, 8-3
- Web Application Management feature, 8-10
- Services chart, databases, 6-5
- Services Dashboard, 8-6
- session details, viewing, 6-7
- setting service-level rules, 8-4
- shared agent patching, 12-9
- Shared Global Area (SGA), for slow or hung systems, 6-16
- software configurations
  - collecting information, 4-1
  - working with, 6-45
- Software Library, using, 12-5
- software patching, 12-8
- SQL
  - details, viewing, 6-7
  - historical, 6-13
- SQL Details page, picture of, 6-7
- stage and apply, for patches, 12-8
- staging region, data masking and, 6-26
- standalone database patching, 12-8
- standby databases, Data Guard and, 6-43
- storage
  - devices, 5-13
  - objects, managing, 6-17
  - resource tracking, 5-8
- System Home page, picture of, 8-6
- System Topology page, picture of, 8-7
- system-based availability, 8-3
- systems
  - creating, 8-4, 8-5
  - definition of, 8-4
  - managing, 8-4
  - monitoring, 8-5
  - privileges, 6-20, 6-22
  - System Topology page, 8-7
  - topologies, viewing and creating, 8-5

- SYSUSER operations, 6-20, 6-22

## T

---

- tablespaces, transporting, 6-44
- third-party
  - application servers, support for, 5-11
  - plug-ins, support for, 5-12
- third-party management, 5-11
  - BIG-IP load balancer switches, 5-14
  - EMC SMARTS, 2-7
  - HP OpenView Operations, 2-7
  - Micromuse, 2-7
  - Network Appliance Filer, 5-13
- Throughput charts, databases, 6-5
- Top Activity page, picture of, 6-9
- top activity, viewing, 6-8
- top consumers, databases, 6-12
- topology
  - database, 6-14
  - service, 8-8
  - system, 8-7
- Topology for SQL Details Plan, picture of, 6-15
- Topology Viewer
  - database, 6-14
  - definition of, 8-5
  - Root Cause Analysis information, 8-12
  - service, 8-8
  - system, 8-7
- tracking
  - statistics for databases, 6-18
  - storage resource allocation, 5-8
- transporting tablespaces, 6-44

## U

---

- undoing patching, 12-12
- usage metrics, services and, 8-3
- use cases, data masking, 6-39
- user-defined
  - functions, data masking and, 6-29
  - searches, enterprise configuration, 4-6
- utility server, 13-3

## V

---

- viewing
  - enterprise configuration, 4-5
  - session details, 6-7
  - SQL details, 6-7
  - top activity, 6-8
- views, database objects and, 6-19
- virtual server, 13-2
- virtual server pool, 13-3
- Virtualization Central, 13-6
- Voting Disk, 6-50

## W

---

- wait classes, databases, 6-6
- Web Application Management feature, services

and, 8-10  
Web Application service type, 8-2  
Workload Repository, database performance  
and, 6-18

## **X**

---

XML database features, 6-19