

Oracle® WebLogic Server

Configuring and Using the WebLogic Diagnostics Framework
10g Release 3 (10.3)

July 2008

ORACLE®

Copyright © 2007, 2008, Oracle and/or its affiliates. All rights reserved.

This software and related documentation are provided under a license agreement containing restrictions on use and disclosure and are protected by intellectual property laws. Except as expressly permitted in your license agreement or allowed by law, you may not use, copy, reproduce, translate, broadcast, modify, license, transmit, distribute, exhibit, perform, publish, or display any part, in any form, or by any means. Reverse engineering, disassembly, or decompilation of this software, unless required by law for interoperability, is prohibited.

The information contained herein is subject to change without notice and is not warranted to be error-free. If you find any errors, please report them to us in writing.

If this software or related documentation is delivered to the U.S. Government or anyone licensing it on behalf of the U.S. Government, the following notice is applicable:

U.S. GOVERNMENT RIGHTS Programs, software, databases, and related documentation and technical data delivered to U.S. Government customers are "commercial computer software" or "commercial technical data" pursuant to the applicable Federal Acquisition Regulation and agency-specific supplemental regulations. As such, the use, duplication, disclosure, modification, and adaptation shall be subject to the restrictions and license terms set forth in the applicable Government contract, and, to the extent applicable by the terms of the Government contract, the additional rights set forth in FAR 52.227-19, Commercial Computer Software License (December 2007). Oracle USA, Inc., 500 Oracle Parkway, Redwood City, CA 94065.

This software is developed for general use in a variety of information management applications. It is not developed or intended for use in any inherently dangerous applications, including applications which may create a risk of personal injury. If you use this software in dangerous applications, then you shall be responsible to take all appropriate fail-safe, backup, redundancy, and other measures to ensure the safe use of this software. Oracle Corporation and its affiliates disclaim any liability for any damages caused by use of this software in dangerous applications.

Oracle is a registered trademark of Oracle Corporation and/or its affiliates. Other names may be trademarks of their respective owners.

This software and documentation may provide access to or information on content, products and services from third parties. Oracle Corporation and its affiliates are not responsible for and expressly disclaim all warranties of any kind with respect to third-party content, products, and services. Oracle Corporation and its affiliates will not be responsible for any loss, costs, or damages incurred due to your access to or use of third-party content, products, or services.

Contents

1. Introduction and Roadmap

What Is the WebLogic Diagnostic Framework?	1-1
Document Scope and Audience	1-2
Guide to This Document	1-3
Related Documentation	1-4
Samples and Tutorials	1-4
Avitek Medical Records Application (MedRec) and Tutorials	1-4
New and Changed Features in this Release	1-5

2. Overview of the WLDF Architecture

Overview of the WebLogic Diagnostic Framework	2-2
Data Creation, Collection, and Instrumentation.	2-3
Archive.	2-4
Watch and Notification	2-5
Data Accessor	2-5
Diagnostic Image Capture	2-6
How It All Fits Together	2-7

3. Understanding WLDF Configuration

Configuration MBeans and XML	3-2
Tools for Configuring WLDF	3-2
How WLDF Configuration Is Partitioned	3-3
Server-Level Configuration	3-3

Application-Level Configuration	3-3
Configuring Diagnostic Image Capture and Diagnostic Archives	3-4
Configuring Diagnostic System Modules	3-5
The Diagnostic System Module and Its Resource Descriptor	3-5
Referencing the Diagnostics System Module from Config.xml	3-5
The <i>DIAG_MODULE.xml</i> Resource Descriptor Configuration	3-7
Managing Diagnostic System Modules	3-8
More Information About Configuring Diagnostic System Resources	3-8
Configuring Diagnostic Modules for Applications	3-9
WLDF Configuration MBeans and Their Mappings to XML Elements	3-10

4. Configuring and Capturing Diagnostic Images

How to Initiate Image Captures	4-1
Configuring Diagnostic Image Captures	4-2
How Diagnostic Image Capture Is Persisted in the Server's Configuration	4-3
Contents of the Captured Image File	4-3

5. Configuring Diagnostic Archives

Configuring the Archive	5-1
Configuring a File-Based Store	5-2
Configuring a JDBC-Based Store	5-3
Creating WLDF Tables in the Database	5-3
Configuring JDBC Resources for WLDF	5-4
Retiring Data from the Archives	5-5
Configuring Data Retirement at the Server Level	5-5
Configuring Age-Based Data Retirement Policies for Diagnostic Archives	5-6
Sample Configuration	5-6

6. Configuring the Harvester for Metric Collection

Harvesting, Harvestable Data, and Harvested Data	6-1
Harvesting Data from the Different Harvestable Entities	6-2
Configuring the Harvester	6-3
Configuring the Harvester Sampling Period	6-4
Configuring the Types of Data to Harvest	6-5
Specifying Type Names for WebLogic Server MBeans and Custom MBeans	6-5
Harvesting from the DomainRuntime MBeanServer	6-6
When Configuration Settings Are Validated	6-7
Sample Configurations for Different Harvestable Types	6-7

7. Configuring Watches and Notifications

Watches and Notifications	7-1
Overview of Watch and Notification Configuration	7-2
Sample Watch and Notification Configuration	7-4

8. Configuring Watches

Types of Watches	8-1
Configuration Options Shared by All Types of Watches	8-2
Configuring Harvester Watches	8-3
Configuring Log Watches	8-6
Configuring Instrumentation Watches	8-7
Defining Watch Rule Expressions	8-7

9. Configuring Notifications

Types of Notifications	9-1
Configuring JMX Notifications	9-2
Configuring JMS Notifications	9-3
Configuring SNMP Notifications	9-4

Configuring SMTP Notifications	9-6
Configuring Image Notifications	9-7

10. Configuring Instrumentation

Concepts and Terminology	10-2
Instrumentation Scope	10-2
Configuration and Deployment	10-2
Joinpoints, Pointcuts, and Diagnostic Locations	10-3
Diagnostic Monitor Types	10-3
Diagnostic Actions	10-5
Instrumentation Configuration Files	10-5
XML Elements Used for Instrumentation	10-7
<Instrumentation> XML Elements	10-7
<wldf-instrumentation-monitor> XML Elements	10-9
Mapping <wldf-instrumentation-monitor> XML Elements to Monitor Types	10-14
Configuring Server-Scoped Instrumentation	10-15
Configuring Application-Scoped Instrumentation	10-17
Comparing System-Scoped to Application-Scoped Instrumentation	10-17
Overview of the Steps Required to Instrument an Application	10-18
Creating a Descriptor File for a Delegating Monitor	10-20
Creating a Descriptor File for a Custom Monitor	10-21

11. Configuring the DyInjection Monitor to Manage Diagnostic Contexts

Contents, Life Cycle, and Configuration of a Diagnostic Context	11-2
Context Life Cycle and the Context ID	11-2
Dyes, Dye Flags, and Dye Vectors	11-2
Where Diagnostic Context Is Configured	11-3

Overview of the Process	11-4
Configuring the Dye Vector via the DyeInjection Monitor	11-5
Dyes Supported by the DyeInjection Monitor	11-7
PROTOCOL Dye Flags	11-8
THROTTLE Dye Flag	11-9
When Diagnostic Contexts Are Created	11-9
Configuring Delegating Monitors to Use Dye Filtering	11-9
How Dye Masks Filter Requests to Pass to Monitors	11-12
Dye Filtering Example	11-13
Using Throttling to Control the Volume of Instrumentation Events	11-14
Configuring the THROTTLE Dye	11-14
How Throttling is Handled by Delegating and Custom Monitors	11-17
Using weblogic.diagnostics.context	11-17

12. Accessing Diagnostic Data With the Data Accessor

Data Stores Accessed by the Data Accessor	12-1
Accessing Diagnostic Data Online	12-2
Accessing Data Using the Administration Console	12-3
Accessing Data Programmatically Using Runtime MBeans	12-3
Using WLST to Access Diagnostic Data Online	12-4
Using the WLDF Query Language with the Data Accessor	12-4
Accessing Diagnostic Data Offline	12-4
Accessing Diagnostic Data Programmatically	12-4
Resetting the System Clock Can Affect How Data Is Archived and Retrieved	12-12

13. Deploying WLDF Application Modules

Deploying a Diagnostic Module as an Application-Scoped Resource	13-2
Using Deployment Plans for Dynamically Controlling Instrumentation Configuration	13-3

Using a Deployment Plan: Overview	13-4
Creating a Deployment Plan Using <code>weblogic.PlanGenerator</code>	13-5
Sample Deployment Plan for Diagnostics	13-6
Enabling Hot-Swap Capabilities	13-7
Deploying an Application with a Deployment Plan	13-7
Updating an Application with a Modified Plan	13-8

14. Configuring and Using WLDF Programmatically

How WLDF Generates and Retrieves Data	14-2
Mapping WLDF Components to Beans and Packages	14-2
Programming Tools	14-6
Configuration and Runtime APIs	14-6
WLDF Packages	14-8
Programming WLDF: Examples	14-9
Example: <code>DiagnosticContextExample.java</code>	14-9
Example: <code>HarvesterMonitor.java</code>	14-10
Example: <code>JMXAccessorExample.java</code>	14-18

A. WLDF Query Language

Components of a Query Expression	A-2
Supported Operators	A-2
Operator Precedence	A-3
Numeric Relational Operations Supported on String Column Types	A-4
Supported Numeric Constants and String Literals	A-4
About Variables in Expressions	A-5
Creating Watch Rule Expressions	A-5
Creating Log Event Watch Rule Expressions	A-6
Creating Instrumentation Event Watch Rule Expressions	A-7

Creating Harvester Watch Rule Expressions	A-8
Creating Data Accessor Queries	A-9
Data Store Logical Names	A-9
Data Store Column Names	A-11
Creating Log Filter Expressions	A-12
Building Complex Expressions	A-13

B. WLDF Instrumentation Library

Diagnostic Monitor Library	B-1
Diagnostic Action Library	B-14

C. Using Wildcards in Expressions

Using Wildcards in Harvester Instance Names	C-1
Specifying Complex and Nested Harvester Attributes	C-3
Using the Accessor with Harvested Complex or Nested Attributes	C-6
Using Wildcards in Watch Rule Instance Names	C-7
Specifying Complex Attributes in Harvester Watch Rules	C-7

D. WebLogic Scripting Tool Examples

Example: Dynamically Creating DyeInjection Monitors	D-1
Example: Configuring a Watch and a JMX Notification	D-5
Example: Writing a JMXWatchNotificationListener Class	D-8
Example: Registering MBeans and Attributes For Harvesting	D-12

E. Terminology

Introduction and Roadmap

The following sections describe the contents and audience for this guide—*Configuring and Using the WebLogic Diagnostic Framework*:

- [“What Is the WebLogic Diagnostic Framework?”](#) on page 1-1
- [“Document Scope and Audience”](#) on page 1-2
- [“Guide to This Document”](#) on page 1-3
- [“Related Documentation”](#) on page 1-4
- [“Samples and Tutorials”](#) on page 1-4
- [“New and Changed Features in this Release”](#) on page 1-5

What Is the WebLogic Diagnostic Framework?

The WebLogic Diagnostic Framework (WLDF) is a monitoring and diagnostic framework that defines and implements a set of services that run within WebLogic Server[®] processes and participate in the standard server life cycle. Using WLDF, you can create, collect, analyze, archive, and access diagnostic data generated by a running server and the applications deployed within its containers. This data provides insight into the run-time performance of servers and applications and enables you to isolate and diagnose faults when they occur.

WLDF includes several components for collecting and analyzing data:

- **Diagnostic Image Capture**—Creates a diagnostic snapshot from the server that can be used for post-failure analysis.
- **Archive**—Captures and persists data events, log records, and metrics from server instances and applications.
- **Instrumentation**—Adds diagnostic code to WebLogic Server instances and the applications running on them to execute diagnostic actions at specified locations in the code. The Instrumentation component provides the means for associating a diagnostic *context* with requests so they can be tracked as they flow through the system.
- **Harvester**—Captures metrics from run-time MBeans, including WebLogic Server MBeans and custom MBeans, which can be archived and later accessed for viewing historical data.
- **Watches and Notifications**—Provides the means for monitoring server and application states and sending notifications based on criteria set in the watches.
- **Logging services**—Manage logs for monitoring server, subsystem, and application events. The WebLogic Server logging services are documented separately from the rest of the WebLogic Diagnostic Framework. See [Configuring Log Files and Filtering Log Messages](#).

WLDF provides a set of standardized application programming interfaces (APIs) that enable dynamic access and control of diagnostic data, as well as improved monitoring that provides visibility into the server. Independent Software Vendors (ISVs) can use these APIs to develop custom monitoring and diagnostic tools for integration with WLDF.

WLDF enables dynamic access to server data through standard interfaces, and the volume of data accessed at any given time can be modified without shutting down and restarting the server.

Document Scope and Audience

This document describes and tells how to configure and use the monitoring and diagnostic services provided by WLDF.

WLDF provides features for monitoring and diagnosing problems in running WebLogic Server instances and clusters and in applications deployed to them. Therefore, the information in this document is directed both to system administrators and to application developers. It also contains information for third-party tool developers who want to build tools to support and extend WLDF.

It is assumed that readers are familiar with Web technologies and the operating system and platform where WebLogic Server is installed.

Guide to This Document

This document is organized as follows:

- This chapter, “Introduction and Roadmap,” provides an overview of WLDF components and describes the audience for this guide.
- [Chapter 2, “Overview of the WLDF Architecture,”](#) provides a high-level view of the WLDF architecture.
- [Chapter 3, “Understanding WLDF Configuration,”](#) provides an overview of how WLDF features are configured for servers and applications.
- [Chapter 4, “Configuring and Capturing Diagnostic Images,”](#) describes how to configure and use the WLDF Diagnostic Image Capture component to capture a snapshot of significant server configuration settings and the server state.
- [Chapter 5, “Configuring Diagnostic Archives,”](#) describes how to configure and use the WLDF Diagnostic Archive component to persist diagnostic data to a file store or database.
- [Chapter 6, “Configuring the Harvester for Metric Collection,”](#) describes how to configure and use the WLDF Harvester component to harvest metrics from runtime MBeans, including WebLogic Server MBeans and custom MBeans.
- [Chapter 7, “Configuring Watches and Notifications,”](#) provides an overview of WLDF watches and notifications.
- [Chapter 8, “Configuring Watches,”](#) describes how to configure watches to monitor server instances and applications for specific conditions and send notifications when those conditions are met.
- [Chapter 9, “Configuring Notifications,”](#) describes how to configure notifications that can be triggered by watches.
- [Chapter 10, “Configuring Instrumentation,”](#) describes how to add diagnostic instrumentation code to WebLogic Server classes and to the classes of applications running on the server.
- [Chapter 11, “Configuring the DyeInjection Monitor to Manage Diagnostic Contexts,”](#) describes how to use the `DyeInjection` monitor and how to use dye filtering with diagnostic monitors.
- [Chapter 12, “Accessing Diagnostic Data With the Data Accessor,”](#) tells how to use the WLDF Data Accessor component to retrieve diagnostic data.

- [Chapter 14, “Configuring and Using WLDF Programmatically,”](#) provides an overview of how you can use the JMX API and the WebLogic Scripting Tool (`weblogic.WLST`) to configure and use WLDF components.
- [Appendix A, “WLDF Query Language,”](#) describes the WLDF query language that is used for constructing expressions to query diagnostic data using the Data Accessor, constructing watch rules, and constructing rules for filtering logs.
- [Appendix B, “WLDF Instrumentation Library,”](#) describes the predefined diagnostic monitors and diagnostic actions that are included in the WLDF Instrumentation Library.
- [Appendix D, “WebLogic Scripting Tool Examples,”](#) provides examples of how to perform WLDF monitoring and diagnostic activities using the WebLogic Scripting Tool.
- [Appendix E, “Terminology,”](#) is a glossary of terms used in WLDF.

Related Documentation

- [Configuring Log Files and Filtering Log Messages](#) describes how to use WLDF logging services to monitor server, subsystem, and application events.
- [“Configure the WebLogic Diagnostic Framework”](#) in the *Administration Console Online Help* describes how to use the visual tools in the WebLogic Administration Console to configure WLDF.
- The WLDF system resource descriptor conforms to the `weblogic-diagnostics.xsd` schema, available at <http://www.bea.com/ns/weblogic/weblogic-diagnostics/1.1/weblogic-diagnostics.xsd>.

Samples and Tutorials

In addition to this document, we provide a variety of samples and tutorials that show WLDF configuration and use.

Avitek Medical Records Application (MedRec) and Tutorials

MedRec is an end-to-end sample J2EE application shipped with WebLogic Server that simulates an independent, centralized medical record management system. The MedRec application provides a framework for patients, doctors, and administrators to manage patient data using a variety of different clients.

MedRec demonstrates WebLogic Server and J2EE features, and highlights recommended best practices. MedRec is included in the WebLogic Server distribution, and can be accessed from the Start menu on Windows machines. For Linux and other platforms, you can start MedRec from the `WL_HOME\samples\domains\medrec` directory, where `WL_HOME` is the top-level installation directory for WebLogic Platform.

New and Changed Features in this Release

For a comprehensive listing of the new WebLogic Server features introduced in this release, see [“What’s New in WebLogic Server”](#) in *Release Notes*.

Introduction and Roadmap

Overview of the WLDF Architecture

The WebLogic Diagnostic Framework (WLDF) consists of a number of components that work together to collect, archive, and access diagnostic information about a WebLogic Server instance and the applications it hosts. This section provides an architectural overview of those components.

Note: Concepts are presented in this section in a way to help you understand how WLDF works. Some of this differs from the way WLDF is surfaced in its configuration and runtime APIs and in the WebLogic Server Console. If you want to start configuring and using WLDF right away, you can safely skip this discussion and start with [Chapter 3, “Understanding WLDF Configuration.”](#)

The WLDF architecture is described in the following sections:

- [“Overview of the WebLogic Diagnostic Framework” on page 2-2](#)
- [“Data Creation, Collection, and Instrumentation” on page 2-3](#)
- [“Archive” on page 2-4](#)
- [“Watch and Notification” on page 2-5](#)
- [“Data Accessor” on page 2-5](#)
- [“Diagnostic Image Capture” on page 2-6](#)
- [“How It All Fits Together” on page 2-7](#)

Overview of the WebLogic Diagnostic Framework

WLDF consists of the following:

- Data creators (data publishers and data providers that are distributed across WLDF components)
- Data collectors (the Logger and the Harvester components)
- Archive component
- Accessor component
- Instrumentation component
- Watch and Notification component
- Image Capture component

Data creators generate diagnostic data that is consumed by the Logger and the Harvester. Those components coordinate with the Archive to persist the data, and they coordinate with the Watch and Notification subsystem to provide automated monitoring. The Accessor interacts with the Logger and the Harvester to expose current diagnostic data and with the Archive to present historical data. The Image Capture facility provides the means for capturing a diagnostic snapshot of a key server state. The relationship among these components is shown in [Figure 2-1](#).

Figure 2-1 Major WLDF Components

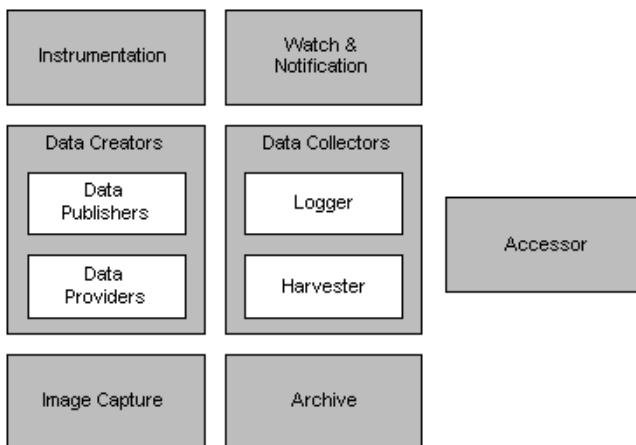

All of the framework components operate at the server level and are only aware of server scope. All the components exist entirely within the server process and participate in the standard server lifecycle. All artifacts of the framework are configured and stored on a per server basis.

Data Creation, Collection, and Instrumentation

Diagnostic data is collected from a number of sources. These sources can be logically classified as either *data providers*, data creators that are sampled at regular intervals to harvest current values, or *data publishers*, data creators that synchronously generate events. Data providers and data publishers are distributed across components, and the generated data can be collected by the Logger and/or by the Harvester, as shown in [Figure 2-2](#), and explained below.

Figure 2-2 Relationship of Data Creation Components to Data Collection Components

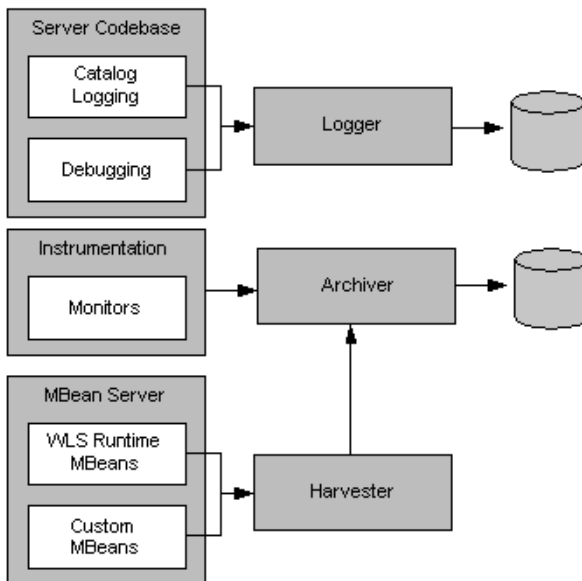

Invocations of the server logging infrastructure serve as inline data publishers, and the generated data is collected as events. (The logging infrastructure can be invoked through the catalog infrastructure, the debugging model, or directly through the Logger.)

The Instrumentation system creates monitors and inserts them at well-defined points in the flow of execution. These monitors publish data directly to the Archive.

Components registered with the MBean Server may also make themselves known as data providers by registering with the Harvester. Collected data is then exposed to both the Watch and Notification system for automated monitoring and to the Archive for persistence.

Archive

The past state is often critical in diagnosing faults in a system. This requires that the state be captured and archived for future access, creating a historical archive. In WLDF, the Archive meets this need with several persistence components. Both events and harvested metrics can be persisted and made available for historical review.

Traditional logging information, which is human readable and intended for inclusion in the server log, is persisted through the standard logging appenders. New event data that is intended for system consumption is persisted into an event store using an event archiver. Metric data is persisted into a data store using a data archiver. The relationship of the Archive to the Logger and the Harvester is shown in [Figure 2-3](#).

The Archive provides access interfaces so that the Accessor may expose any of the persisted historical data.

Figure 2-3 Relationship of the Archive to the Logger and the Harvester

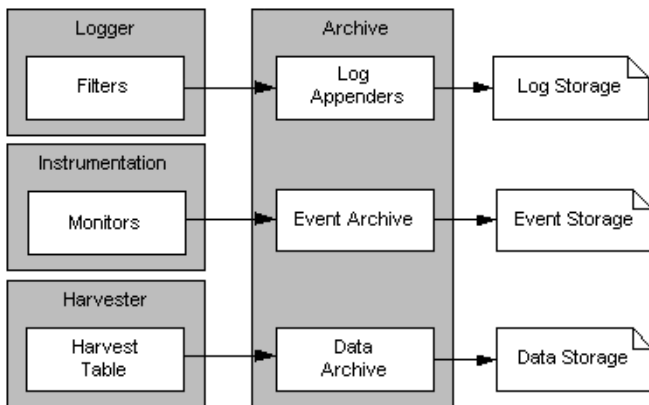

Watch and Notification

The Watch and Notification system can be used to create automated monitors that observe specific diagnostic states and send notifications based on configured rules.

A watch rule can monitor log data, event data from the Instrumentation component, or metric data from a data provider that is harvested by the Harvester. The Watch Manager is capable of managing watches that are composed of a number of watch rules. These relationships are shown in [Figure 2-4](#).

Figure 2-4 Relationship of the Logger and the Harvester to the Watch and Notification System

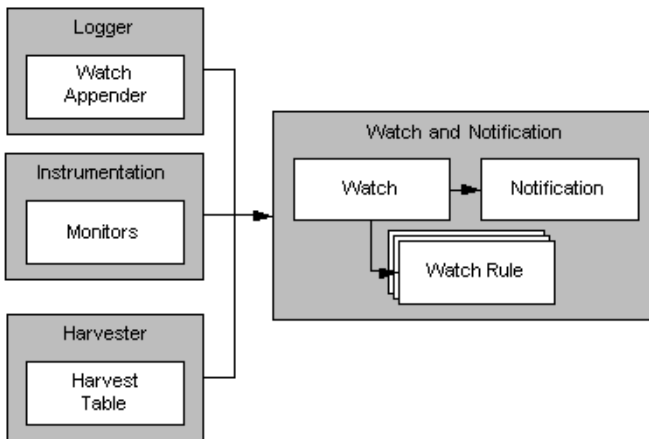

One or more notifications can be configured for use by a watch. By default, every watch logs an event in the server log. SMTP, SNMP, JMX, and JMS notifications are also supported.

Data Accessor

The Accessor provides access to all the data collected by WLDF, including log, event, and metric data. The Accessor interacts with the Archive to get historical data including logged event data and persisted metrics.

When accessing data in a running server, a JMX-based access service is used. The Accessor provides for data lookup by type, by component, and by attribute. It permits time-based filtering and, in the case of events, filtering by severity, source and content.

Tools may need to access data that was persisted by a currently inactive server. In this case, an offline Accessor is also provided. You can use it to export archived data to an XML file for later access. To use the Accessor in this way, you must use the WebLogic Scripting Tool (WLST) and must have physical access to the machine.

The relationship of the Accessor to the Harvester and the Archive is shown in [Figure 2-5](#).

Figure 2-5 Relationship of the Online and Offline Accessors to the Archive

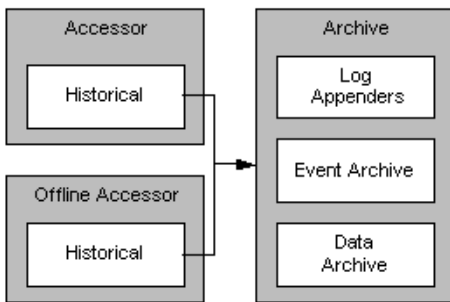

Diagnostic Image Capture

Diagnostic Image Capture support gathers the most common sources of the key server state used in diagnosing problems. It packages that state into a single artifact which can be made available to support technicians, as shown in [Figure 2-6](#). The diagnostic image is in essence a diagnostic snapshot or dump from the server, analogous to a UNIX “core” dump.

Image Capture support includes both an on-demand capture process and an automated capture based on some basic failure detection.

Figure 2-6 Diagnostic Image Capture

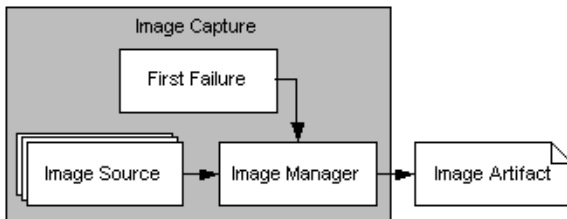

How It All Fits Together

Figure 2-7 shows how all the parts of WLDF fit together.

Figure 2-7 Overall View of the WebLogic Diagnostic Framework

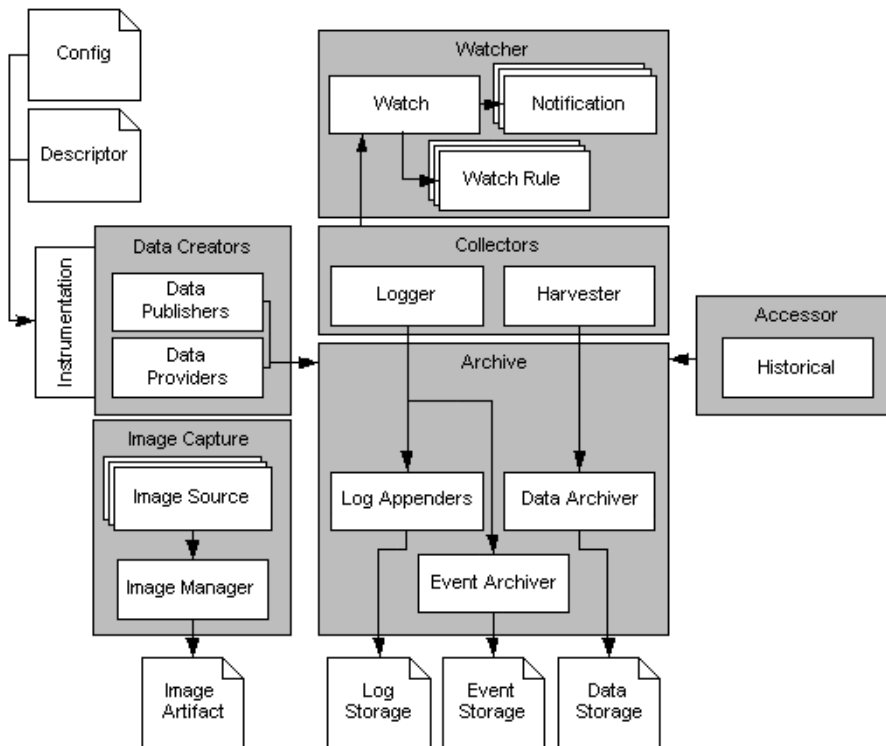

Overview of the WLDF Architecture

Understanding WLDF Configuration

The WebLogic Diagnostic Framework (WLDF) provides features for generating, gathering, analyzing, and persisting diagnostic data from WebLogic Server[®] instances and from applications deployed to them. For server-scoped diagnostics, some WLDF features are configured as part of the configuration for a server in a domain. Other features are configured as system resource descriptors that can be targeted to servers (or clusters). For application-scoped diagnostics, diagnostic features are configured as resource descriptors for the application.

The following sections provide an overview of WLDF configuration:

- “Configuration MBeans and XML” on page 3-2
- “Tools for Configuring WLDF” on page 3-2
- “How WLDF Configuration Is Partitioned” on page 3-3
- “Configuring Diagnostic Image Capture and Diagnostic Archives” on page 3-4
- “Configuring Diagnostic System Modules” on page 3-5
- “Configuring Diagnostic Modules for Applications” on page 3-9
- “WLDF Configuration MBeans and Their Mappings to XML Elements” on page 3-10

For general information about WebLogic Server domain configuration, see *Understanding Domain Configuration*.

Configuration MBeans and XML

As in other WebLogic Server subsystems, WLDF is configured using configuration MBeans (Managed Beans), and the configuration is persisted in XML configuration files. The configuration MBeans are instantiated at startup, based on the configuration settings in `config.xml`. When you modify a configuration by changing the values of MBean attributes, those changes are saved (persisted) in the XML files.

Configuration MBean attributes map directly to configuration XML elements. For example, the `Enable` attribute of the `WLDFInstrumentationBean` maps directly to the `<enabled>` sub-element of the `<instrumentation>` element in the resource descriptor file (configuration file) for a diagnostic module. If you change the value of the MBean attribute, the content of the XML element is changed when the configuration is saved. Conversely, if you were to edit an XML element in the configuration file directly (which is not recommended), the change to an MBean value would take effect after the next session is started.

For more information about WLDF Configuration MBeans, see [“WLDF Configuration MBeans and Their Mappings to XML Elements” on page 3-10](#). For general information about how MBeans are implemented and used in WebLogic Server, see [“Understanding WebLogic Server MBeans”](#) in *Developing Custom Management Utilities with JMX*.

Tools for Configuring WLDF

As with other WebLogic Server subsystems, there are several ways to configure WLDF:

- Use the Administration Console to configure WLDF for server instances and clusters. See [“Configure the WebLogic Diagnostic Framework”](#) in the *Administration Console Online Help*.
- Write scripts to be run in the WebLogic Scripting Tool (WLST). For specific information about using WLST with WLDF, see [Appendix D, “WebLogic Scripting Tool Examples.”](#) Also see [WebLogic Scripting Tool](#) for general information about using WLST.
- Configure WLDF programmatically using JMX and the WLDF configuration MBeans. See [Chapter 14, “Configuring and Using WLDF Programmatically,”](#) for specific information about programming WLDF. See [WebLogic Server MBean Reference](#) and browse or search for specific MBeans for programming reference.
- Edit the XML configuration files directly. This documentation explains many configuration tasks by showing and explaining the XML elements in the configuration files. The XML is easy to understand, and you can edit the configuration files directly, although it is recommended that you do not. (If you have a good reason to edit the files directly, you

should first generate the XML files by configuring WLDF in the Administration Console. Doing so provides a blueprint for valid XML.)

Note: If you make changes to a configuration by editing configuration files, you must restart the server for the changes to take effect.

How WLDF Configuration Is Partitioned

You can use WLDF to perform diagnostics tasks for server instances (and clusters) and for applications.

Server-Level Configuration

You configure the following WLDF components as part of a server instance in a domain. The configuration settings are controlled using MBeans and are persisted in the domain's `config.xml` file.

- Diagnostic Image Capture
- Diagnostic Archives

See [“Configuring Diagnostic Image Capture and Diagnostic Archives” on page 3-4](#).

You configure the following WLDF components as the parts of one or more diagnostic system modules, or resources, that can be deployed to one or more server instances (or clusters). These configuration settings are controlled using Beans and are persisted in one or more diagnostic resource descriptor files (configuration files) that can be targeted to one or more server instances or clusters.

- Harvester (for collecting metrics)
- Watch and Notification
- Instrumentation

See [“Configuring Diagnostic System Modules” on page 3-5](#).

Application-Level Configuration

You can use the WLDF Instrumentation component with applications, as well as at the server level. The Instrumentation component is configured in a resource descriptor file deployed with the application in the application's archive file. See [“Configuring Diagnostic Modules for Applications” on page 3-9](#).

Configuring Diagnostic Image Capture and Diagnostic Archives

In the `config.xml` file for a domain, you configure the Diagnostic Image Capture component and the Diagnostic Archive component in the `<server-diagnostic-config>` element, which is a child of the `<server>` element in a domain, as shown in [Listing 3-1](#).

Listing 3-1 Sample WLDF Configuration Information in the `config.xml` File for a Domain

```
<domain>
  <server>
    <name>myserver</name>
    <server-diagnostic-config>
      <image-dir>logs/diagnostic_images</image-dir>
      <image-timeout>3</image-timeout>
      <diagnostic-store-dir>data/store/diagnostics</diagnostic-store-dir>
      <diagnostic-data-archive-type>FileStoreArchive
    </diagnostic-data-archive-type>
    </server-diagnostic-config>
  </server>

  <!-- Other server elements to configure other servers in this domain -->

  <!-- Other domain-based configuration elements, including references to
      WLDF system resources, or diagnostic system modules.
      See Listing 3-2. -->
</domain>
```

For more information, see the following:

- [Chapter 4, “Configuring and Capturing Diagnostic Images”](#)
- [Chapter 5, “Configuring Diagnostic Archives”](#)

Configuring Diagnostic System Modules

To configure and use the Instrumentation, Harvester, and Watch and Notification components at the server level, you must first create a system resource called a *diagnostic system module*, which will contain the configurations for all those components. Keep in mind that:

- System modules are globally available for targeting to servers and clusters configured in a domain.
- In a given domain, you can create multiple diagnostic system modules with distinct configurations.
- At most, one diagnostic system module can be targeted to any given server or cluster.

The Diagnostic System Module and Its Resource Descriptor

You create a diagnostic system module through the Administration Console or the WebLogic Scripting Tool (WLST). It is created as a `WLDFResourceBean`, and the configuration is persisted in a resource descriptor file (configuration file), called `DIAG_MODULE.xml`, where `DIAG_MODULE` is the name of the diagnostic module. You can specify a name for the descriptor file, but it is not required. If you do not provide a file name, a file name is generated based on the value in the descriptor file's `<name>` element. The file is created by default in the

`DOMAIN_NAME\config\diagnostics` directory, where `DOMAIN_NAME` is the name of the domain's home directory. The file has the extension `.xml`.

Note: The diagnostic module conforms to the `diagnostics.xsd` schema, available at <http://www.bea.com/ns/weblogic/weblogic-diagnostics/1.1/weblogic-diagnostics.xsd>.

For instructions on creating a diagnostic system module, see “[Create diagnostic system modules](#)” in the *Administration Console Online Help*.

Referencing the Diagnostics System Module from Config.xml

When you create a diagnostic system module using the Administration Console or the WebLogic Scripting Tool (WLST), WebLogic Server creates it in `DOMAIN_NAME/config/diagnostics`, and a reference to the module is added to the domain's `config.xml` file.

Note: Oracle recommends that you do not write XML configuration files directly. But if you have a valid reason to do so, you should first create a diagnostic module from the Console. That way, you can start with the valid XML that the Console creates. For

instructions, see [“Create diagnostic system modules”](#) in the *Administration Console Online Help*.

The `config.xml` file can contain multiple references to diagnostic modules, in one or more `<wldf-system-resource>` elements. The `<wldf-system-resource>` element includes the name of the diagnostic module file and the list of servers and clusters to which the module is targeted.

For example, [Listing 3-2](#) shows a `config.xml` file with a module named `myDiagnosticModule` targeted to the server `myserver` and another module named `newDiagnosticMod` targeted to servers `ManagedServer1` and `ManagedServer2`.

Listing 3-2 Sample WLDf Configuration Information in the Config.xml File for a Domain

```
<domain>

  <!-- Other domain-level configuration elements -->

  <wldf-system-resource
    xmlns="http://www.bea.com/ns/weblogic/90/diagnostics">

    <name>myDiagnosticModule</name>
    <target>myserver</target>
    <descriptor-file-name>diagnostics/MyDiagnosticModule.xml
    </descriptor-file-name>
    <description>My diagnostic module</description>
  </wldf-system-resource>

  <wldf-system-resource>
    <name>newDiagnosticMod</name>
    <target>ManagedServer1,ManagedServer2</target>
    <descriptor-file-name>diagnostics/newDiagnosticMod.xml
    </descriptor-file-name>
    <description>A diagnostic module for my managed servers</description>
  </wldf-system-resource>

  <!-- Other WLDf system resource configurations -->

</domain>
```

The relationship of the `config.xml` file and the `MyDiagnosticModule.xml` file is shown in Figure 3-1.

Figure 3-1 Relationship of `config.xml` to System Descriptor File

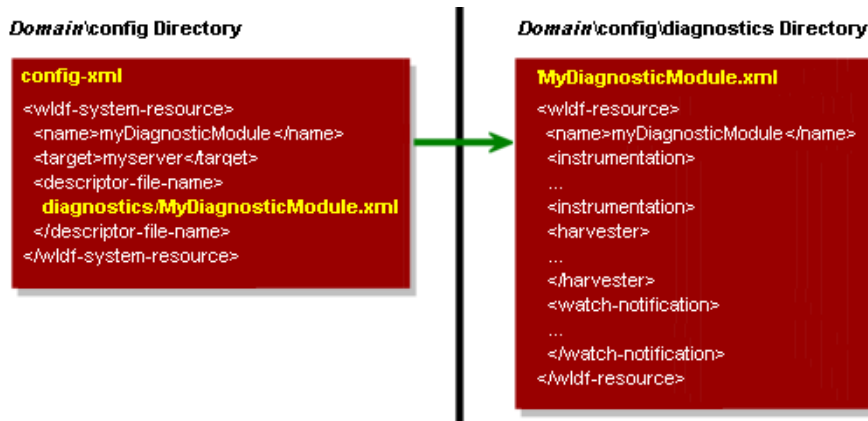

The *DIAG_MODULE.xml* Resource Descriptor Configuration

Except for the name and list of targets, which are listed in the `config.xml` file, as described above, all configuration for a diagnostic system module is saved in its resource descriptor file. Listing 3-3 shows portions of the descriptor file for a diagnostic system module named `myDiagnosticModule`.

Listing 3-3 Sample Structure of a Diagnostic System Module Descriptor File, `MyDiagnosticModule.xml`

```

<wldf-resource xmlns="http://www.bea.com/ns/weblogic/weblogic-diagnostics"
  xmlns:xsi="http://www.w3.org/2001/XMLSchema-instance"
  xsi:schemaLocation="http://www.bea.com/ns/weblogic/weblogic-diagnostics
/1.1/weblogic-diagnostics.xsd">
  <name>MyDiagnosticModule</name>
  <instrumentation>
    <!-- Configuration elements for zero or more diagnostic monitors -->
  </instrumentation>
  <harvester>
    <!-- Configuration elements for harvesting metrics from zero or more

```

```
        MBean types, instances, and attributes -->
</harvester>

<watch-notification>
    <!-- Configuration elements for one or more watches and one or more
        notifications-->
</watch-notification>

</wldf-resource>
```

Managing Diagnostic System Modules

A diagnostic system module can be targeted to zero, one, or more servers, although a given server can have only one module targeted to it at a time. You can create multiple modules that monitor different aspects of your system. You can then choose which module to target to a server or cluster, based on what you want to monitor at that time.

Because you can target the same module to multiple servers or clusters, you can write general purpose modules that you want to use across a domain.

You can change the target of a diagnostic module without restarting the server instance(s) to which it is targeted or untargeted. This gives you considerable flexibility in writing and using diagnostic monitors that address a specific diagnostic goal, without interfering with the operation of the server instances themselves.

More Information About Configuring Diagnostic System Resources

See the following sections for detailed instructions on configuring WLDf system resources:

- [Chapter 6, “Configuring the Harvester for Metric Collection”](#)
- [Chapter 7, “Configuring Watches and Notifications”](#)
- [Chapter 10, “Configuring Instrumentation”](#)
- [Chapter 11, “Configuring the DyeInjection Monitor to Manage Diagnostic Contexts”](#)

Configuring Diagnostic Modules for Applications

You can configure only the Instrumentation component in a diagnostic descriptor for an application.

You configure and deploy application-scoped instrumentation as a diagnostic module, which is similar to a diagnostic system module. However, an application module is configured in an XML descriptor (configuration) file named `weblogic-diagnostics.xml`, which is packaged with the application archive in the `ARCHIVE_PATH/META-INF` directory for the deployed application. For example,

```
D:\bea\wlserver_10.3\samples\server\medrec\dist\standalone\exploded\medrec\META-INF\weblogic-diagnostics.xml
```

Note: The `DyeInjection` monitor, which is used to configure diagnostic context (a way of tracking requests as they flow through the system), can be configured only at the server level. But once a diagnostic context is created, the context attached to incoming requests remains with the requests as they flow through the application. For information about the diagnostic context, see [Chapter 11, “Configuring the DyeInjection Monitor to Manage Diagnostic Contexts.”](#)

For more information about configuring and deploying diagnostic modules for applications, see:

- [“Configuring Application-Scoped Instrumentation,”](#) in [Chapter 10, “Configuring Instrumentation.”](#)
- [Chapter 13, “Deploying WLDF Application Modules.”](#)

WLDF Configuration MBeans and Their Mappings to XML Elements

Figure 3-2 shows the hierarchy of the WLDF configuration MBeans and the diagnostic system module beans for WLDF objects in a WebLogic Server domain.

Figure 3-2 WLDF Configuration Bean Tree

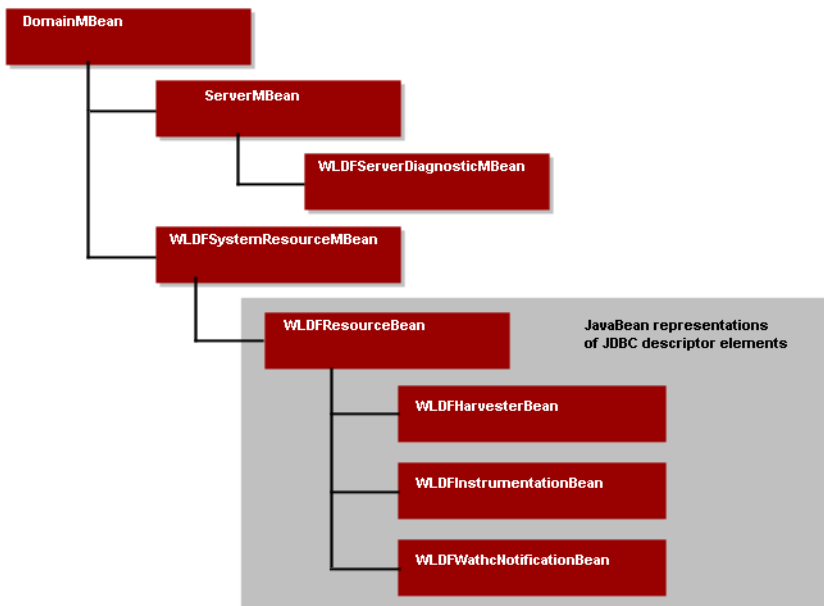

The following WLDF MBeans configure WLDF at the server level. They map to XML elements in the `config.xml` configuration file for a domain:

- `WLDFServerDiagnosticMBean` controls configuration settings for the Data Archive and Diagnostic Images components for a server. It also controls whether diagnostic context for a diagnostic module is globally enabled or disabled. (Diagnostic context is a way to uniquely identify requests and track them as they flow through the system. See [Chapter 11, “Configuring the DyeInjection Monitor to Manage Diagnostic Contexts.”](#))

This MBean is represented by a `<server-diagnostic-config>` child element of the `<server>` element in the `config.xml` file for the server’s domain.

- `WLDFSystemResourceMBean` contains the name of a descriptor file for a diagnostic module in the `DOMAIN_NAME/config/diagnostics` directory and the name(s) of the target server(s) to which that module is deployed.

This MBean is represented by a `<wldf-system-resource>` element in the `config.xml` file for the domain.

Note: You can create multiple diagnostic system modules in a domain. The configurations for the modules are saved in multiple descriptor files in the `config/diagnostics` directory for the domain. The domain's `config.xml` file, therefore, can contain the multiple `<wldf-system-resource>` elements that represent those modules. However, you can target only one diagnostic system module to a server at a time. You cannot have two files in the `config/diagnostics` directory whose active target is the same server.

- `WLDFResourceBean` contains the configuration settings for a diagnostic system module. This bean is represented by a `<wldf-resource>` element in a `DIAG_MODULE.xml` diagnostics descriptor file in the domain's `config/diagnostics` directory. (See [Figure 3-1](#) and [Listing 3-3](#).) The `WLDFResourceBean` contains configuration settings for the following components:
 - **Harvester:** The `WLDFHarvesterBean` is represented by the `<harvester>` element in a `DIAG_MODULE.xml` file.
 - **Instrumentation:** The `WLDFInstrumentationBean` is represented by the `<instrumentation>` element in a `DIAG_MODULE.xml` file.
 - **Watch and Notification:** The `WLDFWatchNotificationBean` is represented by the `<watch-notification>` element in a `DIAG_MODULE.xml` file.

If a `WLDFResourceBean` is linked from a `WLDFSystemResourceMBean`, the settings for WLDF components apply to the targeted server. If a `WLDFResourceBean` is contained within a `weblogic-diagnostics.xml` descriptor file which is deployed as part of an application archive, you can configure only the Instrumentation component, and the settings apply only to that application. In the latter case, the `WLDFResourceMBean` is not a child of a `WLDFSystemResourceMBean`.

Understanding WLDF Configuration

Configuring and Capturing Diagnostic Images

You use the Diagnostic Image Capture component of the WebLogic Diagnostic Framework (WLDF) to create a diagnostic snapshot, or dump, of a server's internal runtime state at the time of the capture. This information helps support personnel analyze the cause of a server failure.

The following topics describe the Diagnostic Image Capture component:

- [“How to Initiate Image Captures”](#) on page 4-1
- [“Configuring Diagnostic Image Captures”](#) on page 4-2
- [“How Diagnostic Image Capture Is Persisted in the Server's Configuration”](#) on page 4-3
- [“Contents of the Captured Image File”](#) on page 4-3

How to Initiate Image Captures

A diagnostic image capture can be initiated by:

- A configured watch notification. See [Chapter 9, “Configuring Notifications.”](#)
- A request initiated by a user in the Administration Console (and requests initiated from third-party diagnostic tools). See [“Configure and capture diagnostic images”](#) in the *Administration Console Online Help*.
- A direct API call, using JMX. See [Listing 4-1](#)
- WLST command

Configuring Diagnostic Image Captures

Because the diagnostic image capture is meant primarily as a post-failure analysis tool, there is little control over what information is captured. Available configuration options are:

- The destination for the image
- For a specific capture, a destination that is different from the default destination
- A lockout, or *timeout*, period, to control how often an image is taken during a sequence of server failures and recoveries

As with other WLDF components, you can configure Diagnostic Image Capture using the Administration Console (see “[Configure and capture diagnostic images](#)” in the *Administration Console Online Help*), the WebLogic Scripting Tool (WLST), or programmatically.

[Listing 4-1](#) shows an example of WLST commands for generating an image capture.

Listing 4-1 Sample WLST Commands for Generating a Diagnostic Image

```
url='t3://localhost:7001'
username='system'
password='gumby1234'
server='myserver'
timeout=120
connect(username, password, url)
serverRuntime()
cd('WLDFRuntime/WLDFRuntime/WLDFImageRuntime/Image')
argTypes = jarray.array(['java.lang.Integer', java.lang.String])
argValues = jarray.array([timeout], java.lang.Object)
invoke('captureImage', argValues, argTypes)
```

Note: It is often useful to generate a diagnostic image capture when a server fails. To do so, set a watch rule to evaluate to true when the server’s state changes to FAILED; then associate an image notification with the watch.

The watch rule is as follows:

```
($ {[weblogic.management.runtime.ServerRuntimeMBean]//State} =
'FAILED')
```

For more information, see “[Configuring Harvester Watches](#)” on page 8-3 and “[Configuring Image Notifications](#)” on page 9-7. Also see “[Configure Watches and Notifications](#)” in the *Administration Console Online Help*.

How Diagnostic Image Capture Is Persisted in the Server's Configuration

The configuration for Diagnostic Image Capture is persisted in the `config.xml` file for a domain, under the `<server-diagnostic-config>` sub-element of the `<server>` element for the server, as shown in [Listing 4-2](#):

Listing 4-2 Sample Diagnostic Image Capture Configuration

```
<domain>
  <!-- Other domain configuration elements -->
  <server>
    <name>myserver</name>
    <server-diagnostic-config>
      <image-dir>logs\diagnostic_images</image-dir>
      <image-timeout>2</image-timeout>
    </server-diagnostic-config>
    <!-- Other configuration details for this server -->
  </server>
  <!-- Other server configurations in this domain-->
</domain>
```

Note: Oracle recommends that you do not edit the `config.xml` file directly.

Contents of the Captured Image File

The most common sources of a server state are captured in a diagnostic image capture, including:

- Configuration
- Log cache state
- Java Virtual Machine (JVM)

- Work Manager state
- JNDI state
- Most recent harvested data

The Diagnostic Image Capture component captures and combines the images produced by the different server subsystems into a single ZIP file. In addition to capturing the most common sources of the server state, this component captures images from all the server subsystems including, for example, images produced by the JMS, JDBC, EJB, and JNDI subsystems.

Note: A diagnostic image is a heavyweight artifact meant to serve as a server-level state dump for the purpose of diagnosing significant failures. It enables you to capture a significant amount of important data in a structured format and then to provide that data to support personnel for analysis.

Each image is captured as a single file for the entire server. The default location is `SERVER\logs\diagnostic_images`. Each image instance has a unique name, as follows:

```
diagnostic_image_DOMAIN_SERVER_YYYY_MM_DD_HH_MM_SS.zip
```

The contents of the file include at least the following information:

- Creation date and time of the image
- Source of the capture request
- Name of each image source included in the image and the time spent processing each of those image sources
- JVM and OS information, if available
- Command line arguments, if available
- WLS version including patch and build number information

Figure 4-1 shows the contents of an image file. You can open most of the files in this ZIP file with a text editor to examine the contents.

Figure 4-1 An Image File

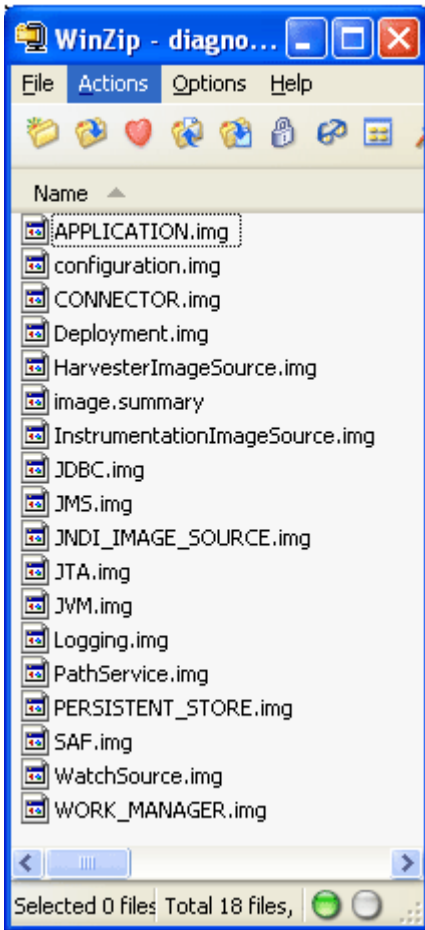

Configuring and Capturing Diagnostic Images

Configuring Diagnostic Archives

The Archive component of the WebLogic Diagnostic Framework (WLDF) captures and persists all data events, log records, and metrics collected by WLDF from server instances and applications running on them. You can access archived diagnostic data in online mode (that is, on a running server). You can also access archived data in off-line mode using the WebLogic Scripting Tool (WLST).

You can configure WLDF to archive diagnostic data to a file store or a Java Database Connectivity (JDBC) data source, as described in the following sections:

- [“Configuring the Archive” on page 5-1](#)
- [“Configuring a File-Based Store” on page 5-2](#)
- [“Configuring a JDBC-Based Store” on page 5-3](#)

You can also specify when and under what conditions old data will be removed from the archive, as described in the following section:

- [“Retiring Data from the Archives” on page 5-5](#)

Configuring the Archive

You configure the diagnostic archive on a per-server basis. The configuration is persisted in the `config.xml` file for a domain, under the `<server-diagnostic-config>` element for the server. Example configurations for file-based stores and JDBC-based stores are shown in [Listing 5-1](#) and [Listing 5-3](#).

Note: Resetting the system clock while diagnostic data is being written to the archive can produce unexpected results. See [“Resetting the System Clock Can Affect How Data Is Archived and Retrieved”](#) on page 12-12.

Configuring a File-Based Store

For a file-based store, WLDF creates a file to contain the archived information. The only configuration option for a WLDF file-based archive is the directory where the file will be created and maintained. The default directory is

DOMAIN_NAME/servers/*SERVER_NAME*/data/store/diagnostics, where *DOMAIN_NAME* is the home directory for the domain, and *SERVER_NAME* is the home directory for the server instance.

When you save to a file-based store, WLDF uses the WebLogic Server persistent store. For more information, see [“Using the WebLogic Persistent Store”](#) in *Configuring WebLogic Server Environments*.

An example configuration for a file-based store is shown in [Listing 5-1](#).

Listing 5-1 Sample Configuration for File-based Diagnostic Archive (in config.xml)

```
<domain>
  <!-- Other domain configuration elements -->
  <server>
    <name>myserver</name>
    <server-diagnostic-config>
      <diagnostic-store-dir>data/store/diagnostics</diagnostic-store-dir>
      <diagnostic-data-archive-type>FileStoreArchive
    </diagnostic-data-archive-type>
    </server-diagnostic-config>
  </server>
  <!-- Other server configurations in this domain -->
</domain>
```

Configuring a JDBC-Based Store

To use a JDBC store, the appropriate tables must exist in a database, and JDBC must be configured to connect to that database.

Creating WLDF Tables in the Database

If they do not already exist, you must create the database tables used by WLDF to store data in a JDBC-based store. Two tables are required:

- The `wls_events` table stores data generated from WLDF Instrumentation events.
- The `wls_hvst` table stores data generated from the WLDF Harvester component.

The SQL Data Definition Language (DDL) used to create tables may differ for different databases, depending on the SQL variation supported by the database. The following code listing shows the DDL that you can use to create WLDF tables in the PointBase database.

Listing 5-2 DDL Definition of the WLDF Tables for PointBase Database

```
-- DDL for creating wls_events table for instrumentation events

DROP TABLE wls_events;
CREATE TABLE wls_events (
    RECORDID INTEGER IDENTITY,
    TIMESTAMP NUMERIC default NULL,
    CONTEXTID varchar(128) default NULL,
    TXID varchar(32) default NULL,
    USERID varchar(32) default NULL,
    TYPE varchar(64) default NULL,
    DOMAIN varchar(64) default NULL,
    SERVER varchar(64) default NULL,
    SCOPE varchar(64) default NULL,
    MODULE varchar(64) default NULL,
    MONITOR varchar(64) default NULL,
    FILENAME varchar(64) default NULL,
    LINENUM INTEGER default NULL,
    CLASSNAME varchar(250) default NULL,
    METHODNAME varchar(64) default NULL,
    METHODDSC varchar(4000) default NULL,
```

Configuring Diagnostic Archives

```
ARGUMENTS clob(100000) default NULL,  
RETVAL varchar(4000) default NULL,  
PAYLOAD blob(100000),  
CTXPAYLOAD VARCHAR(4000),  
DYES NUMERIC default NULL,  
THREADNAME varchar(128) default NULL  
);  
  
-- DDL for creating wls_events table for instrumentation events  
  
DROP TABLE wls_hvst;  
CREATE TABLE wls_hvst (  
    RECORDID INTEGER IDENTITY,  
    TIMESTAMP NUMERIC default NULL,  
    DOMAIN varchar(64) default NULL,  
    SERVER varchar(64) default NULL,  
    TYPE varchar(64) default NULL,  
    NAME varchar(250) default NULL,  
    ATTRNAME varchar(64) default NULL,  
    ATTRTYPE INTEGER default NULL,  
    ATTRVALUE VARCHAR(4000)  
);  
  
COMMIT;
```

Consult the documentation for your database or your database administrator for specific instructions for creating these tables for your database.

Configuring JDBC Resources for WLDF

After you create the tables in your database, you must configure JDBC to access the tables. (See [Configuring and Managing WebLogic JDBC](#).) Then, as part of your server configuration, you specify that JDBC resource as the data store to be used for a server's archive.

An example configuration for a JDBC-based store is shown in [Listing 5-3](#).

Listing 5-3 Sample configuration for JDBC-based Diagnostic Archive (in config.xml)

```

<domain>
  <!-- Other domain configuration elements -->
  <server>
    <name>myserver</name>
    <server-diagnostic-config>
      <diagnostic-data-archive-type>JDBCArchive
    </diagnostic-data-archive-type>
    <diagnostic-jdbc-resource>JDBCResource</diagnostic-jdbc-resource>
    <server-diagnostic-config>
  </server>
  <!-- Other server configurations in this domain -->
</domain>

```

If you specify a JDBC resource but it is configured incorrectly, or if the required tables do not exist in the database, WLDF uses the default file-based persistent store.

Retiring Data from the Archives

WLDF includes a configuration-based data retirement feature for periodically deleting old diagnostic data from the archives. You can configure size-based data retirement at the server level and age-based retirement at the individual archive level, as described in the following sections.

Configuring Data Retirement at the Server Level

You can set the following data retirement options for a server instance:

- The preferred maximum size of the server instance’s data store (`<preferred-store-size-limit>`) and the interval at which it is checked, on the hour, to see if it exceeds that size (`<store-size-check-period>`).

When the size of the store is found to exceed the preferred maximum, an appropriate number of the oldest records in the store are deleted to reduce the size below the specified threshold. This is called “size-based data retirement.”

Note: Size-based data retirement can be used only for file-based stores. These options are ignored for database-based stores.

- Enable or disable data retirement for the server instance.

For file-based stores, this enables or disables the size-based data retirement options discussed above. For both file-based stores and database-based stores, this also enables or disables any age-based data retirement policies defined for individual archives in the store. See “[Configuring Age-Based Data Retirement Policies for Diagnostic Archives](#),” below.

Configuring Age-Based Data Retirement Policies for Diagnostic Archives

The data store for a server instance can contain the following types of diagnostic data archives whose records can be retired using the data retirement feature:

- Harvested metrics data (logical name: `HarvestedDataArchive`)
- Instrumentation events data (logical name: `EventsDataArchive`)
- Custom data (user-defined name)

Note: WebLogic Server log files are maintained both at the server level and the domain level. Data is retired from the current log using the log rotation feature. See “[Configuring WebLogic Logging Services](#)” in *Configuring Log Files and Filtering Log Messages*.

Age-based policies apply to individual archives. The data store for a server instance can have one age-based policy for the `HarvestedDataArchive`, one for the `EventsDataArchive`, and one each for any custom archives.

When records in an archive exceed the age limit specified for records in that archive, those records are deleted.

Sample Configuration

Data retirement configuration settings are persisted in the `config.xml` configuration file for the server’s domain, as shown in [Listing 5-4](#).

Listing 5-4 Data Retirement Configuration Settings in `config.xml`

```
<domain>
<!-- other domain configuration settings -->
  <server>
```



```
<name>MedRecServer</name>
<!-- other server configuration settings -->
<server-diagnostic-config>
  <diagnostic-store-dir>data/store/diagnostics</diagnostic-store-dir>
  <diagnostic-data-archive-type>FileStoreArchive
    </diagnostic-data-archive-type>
  <data-retirement-enabled>true</data-retirement-enabled>
  <preferred-store-size-limit>120</preferred-store-size-limit>
  <store-size-check-period>1</store-size-check-period>
  <wldf-data-retirement-by-age>
    <name>HarvestedDataRetirementPolicy</name>
    <enabled>true</enabled>
    <archive-name>HarvestedDataArchive</archive-name>
    <retirement-time>1</retirement-time>
    <retirement-period>24</retirement-period>
    <retirement-age>45</retirement-age>
  </wldf-data-retirement-by-age>
  <wldf-data-retirement-by-age>
    <name>EventsDataRetirementPolicy</name>
    <enabled>true</enabled>
    <archive-name>EventsDataArchive</archive-name>
    <retirement-time>10</retirement-time>
    <retirement-period>24</retirement-period>
    <retirement-age>72</retirement-age>
  </wldf-data-retirement-by-age>
</server-diagnostic-config>
</server>
</domain>
```

Configuring Diagnostic Archives

Configuring the Harvester for Metric Collection

The Harvester component of the WebLogic Diagnostic Framework (WLDF) gathers metrics from attributes on qualified MBeans that are instantiated in a running server. The Harvester can collect metrics from WebLogic Server[®] MBeans and from custom MBeans.

The following sections describe harvesting and the Harvester configuration process:

- [“Harvesting, Harvestable Data, and Harvested Data”](#) on page 6-1
- [“Harvesting Data from the Different Harvestable Entities”](#) on page 6-2
- [“Configuring the Harvester”](#) on page 6-3

Harvesting, Harvestable Data, and Harvested Data

Harvesting metrics is the process of gathering data that is useful for monitoring the system state and performance. Metrics are exposed to WLDF as attributes on qualified MBeans. The Harvester gathers values from selected MBean attributes at a specified sampling rate. Therefore, you can track potentially fluctuating values over time.

Data must meet certain requirements in order to be *harvestable*, and it must meet further requirements in order to be *harvested*:

- *Harvestable data* is data that can potentially be harvested from *harvestable entities*, including MBean types, instances, and attributes. To be harvestable, an MBean must be registered in the local WebLogic Server runtime MBean server. Only simple type attributes of an MBean can be harvestable.

- *Harvested data* is data that is currently being harvested. To be harvested, the data must meet all the following criteria:
 - The data must be *harvestable*.
 - The data must be configured to be harvested.
 - For custom MBeans, the MBean must be currently registered with the JMX server.
 - The data must not throw exceptions while being harvested.

The `WLDHArvesterRuntimeMBean` provides the set of harvestable data and harvested data. The information returned by this MBean is a snapshot of a potentially changing state. For a description of the information about the data provided by this MBean, see the description of the `weblogic.management.runtime.WLDHArvesterRuntimeMBean` in the *WebLogic Server MBean Reference*.

You can use the Administration Console, the WebLogic Scripting Tool (`weblogic.WLST`), or JMX to configure the harvester to collect and archive the metrics that the server MBeans and the custom MBeans contain.

Harvesting Data from the Different Harvestable Entities

You can configure the Harvester to harvest data from named MBean types, instances, and attributes. In all cases, the Harvester collects the values of attributes of MBean instances, as explained in [Table 6-1](#).

Table 6-1 Sources of Harvested Data from Different Configurations

When this entity is configured to be harvested as...	Data is collected from...
A type (only)	All harvestable attributes in all instances of the specified type
An attribute of a type (type + attribute(s))	The specified attribute in all instances of the specified type
An instance of a type (type + instance(s))	All harvestable attributes in the specified instance of the specified type
An attribute of an instance of a type (type + instance(s) + attribute(s))	The specified attribute in the specified instance of the specified type

All WebLogic Server runtime MBean types and attributes are known at startup. Therefore, when the Harvester configuration is loaded, the set of harvestable WebLogic Server entities is the same as the set of WebLogic Server runtime MBean types and attributes. As types are instantiated, those instances also become known and thus harvestable.

The set of harvestable custom MBean types is dynamic. A custom MBean must be instantiated before its type can be known. (The type does not exist until at least one instance is created.) Therefore, as custom MBeans are registered with and removed from the MBean server, the set of custom harvestable types grows and shrinks. This process of detecting a new type based on the registration of a new MBean is called *type discovery*.

When you configure the Harvester through the Administration Console, the Console provides a list of harvestable entities that can be configured. The list is always complete for WebLogic Server MBeans, but for custom MBeans, the list contains only the currently discovered types. See [“Configure metrics to collect in a diagnostic system module”](#) in the *Administration Console Online Help*.

Configuring the Harvester

The Harvester is configured and metrics are collected in the scope of a diagnostic module targeted to one or more server instances.

[Listing 6-1](#) shows Harvester configuration elements in a WLDF system resource descriptor file, `myWLDF.xml`. This sample configuration harvests from the `ServerRuntimeMBean`, the `WLDFHarvesterRuntimeMBean`, and from a custom (non-WLS) MBean. The text following the listing explains each element in the listing.

Listing 6-1 Sample Harvester Configuration (in `DIAG_MODULE.xml`)

```
<wldf-resource xmlns="http://www.bea.com/ns/weblogic/weblogic-diagnostics"
  xmlns:xsi="http://www.w3.org/2001/XMLSchema-instance">
  <name>myWLDF</name>
  <harvester>
    <enabled>true</enabled>
    <sample-period>5000</sample-period>
```

Configuring the Harvester for Metric Collection

```
<harvested-type>
  <name>weblogic.management.runtime.ServerRuntimeMBean</name>
</harvested-type>

<harvested-type>
  <name>weblogic.management.runtime.WLDFHarvesterRuntimeMBean</name>
  <harvested-attribute>TotalSamplingTime</harvested-attribute>
  <harvested-attribute>CurrentSnapshotElapsedTime
  </harvested-attribute>
</harvested-type>

<harvested-type>
  <name>myMBeans.MySimpleStandard</name>
  <harvested-instance>myCustomDomain:Name=myCustomMBean1
  </harvested-instance>
  <harvested-instance>myCustomDomain:Name=myCustomMBean2
  </harvested-instance>
</harvested-type>

</harvester>

<!-- ----- Other elements ----- -->

</wldf-resource>
```

Configuring the Harvester Sampling Period

The `<sample-period>` element sets the sample period for the Harvester, in milliseconds. For example:

```
<sample-period>5000</sample-period>
```

The sample period specifies the time between each cycle. For example, if the Harvester begins execution at time T , and the sample period is I , then the next harvest cycle begins at $T+I$. If a cycle takes A seconds to complete and if A exceeds I , then the next cycle begins at $T+A$. If this occurs, the Harvester tries to start the next cycle sooner, to ensure that the average interval is I .

Configuring the Types of Data to Harvest

One or more `<harvested-type>` elements determine the types of data to harvest. Each `<harvested-type>` element specifies an MBean type from which metrics are to be collected. Optional sub-elements specify the instances and/or attributes to be collected for that type. Set these options as follows:

- The optional `<harvested-instance>` element specifies that metrics are to be collected only from the listed instances of the specified type. In general, an instance is specified by providing its JMX `ObjectName` in JMX canonical form. You can, however, use pattern-matching to specify instance names in non-canonical form, as described in [“Using Wildcards in Harvester Instance Names” on page C-1](#).
- If no `<harvested-instance>` is present, all instances that are present at the time of each harvest cycle are collected.
- The optional `<harvested-attribute>` element specifies that metrics are to be collected only for the listed attributes of the specified type. An attribute is specified by providing its name. The first character should be capitalized. For example, an attribute defined with getter method `getFoo()` is named `Foo`.

The `<harvested-attribute>` element also supports an expression syntax for “drilling down” into attributes that are complex or aggregate objects, such as lists, maps, simple POJOs (Plain Old Java Objects), and various nestings of these types. See [“Specifying Complex and Nested Harvester Attributes” on page C-3](#) for details on this syntax. Note, however, that the result of these expressions must be a simple intrinsic type (`int`, `boolean`, `String`, etc.) in order to be harvested.

- If no `<harvested-attribute>` is present, all harvestable attributes defined for the type are collected.
- Attribute and instance lists can be combined in a type.

Specifying Type Names for WebLogic Server MBeans and Custom MBeans

The Harvester supports WebLogic Server MBeans and custom MBeans. WebLogic Server MBeans are those that come packaged as part of the WebLogic Server. Custom MBeans can be harvested as long as they are registered in the local runtime MBean server.

There is a difference in how WebLogic Server and customer types are specified. For WebLogic Server types, the type name is the name of the Java interface that defines the MBean. For

example, the server runtime MBean's type name is `weblogic.management.runtime.ServerRuntimeMBean`.

For custom MBeans, the Harvester follows these rules:

- If the MBean is not a `ModelMBean`, the type name is the implementing class name. (For example, see [Listing 6-1](#).)
- If the MBean is a `ModelMBean`, the type name is the value of the MBean Descriptor field `DiagnosticTypeName`.

If neither of these conditions is satisfied (if the MBean is a `ModelMBean` and there is no value for the MBean Descriptor field `DiagnosticTypeName`) then the MBean can't be harvested.

Harvesting from the DomainRuntime MBeanServer

The `<harvested-type>` element supports a `<namespace>` attribute that lets you harvest metrics from MBeans registered in the DomainRuntime MBeanServer. Oracle recommends, however, that you limit the usage to harvesting only DomainRuntime-specific MBeans, such as the `ServerLifecycleRuntimeMBean`. Harvesting of remote managed server MBeans through the DomainRuntime MBeanServer is possible, but is discouraged for performance reasons. It is a best practice to use the resident Harvester in each managed server to capture metrics related to that managed server instance.

The `<namespace>` attribute can have one of two values:

- `ServerRuntime`
- `DomainRuntime`

If the `<namespace>` attribute is omitted, it defaults to `ServerRuntime`.

Note: Harvesting from the DomainRuntime MBean server is available only on the admin server. Attempts to harvest DomainRuntime MBeans on a managed server will be ignored. For an example, see [Listing 6-5](#).

When Configuration Settings Are Validated

WLDF attempts to validate configuration as soon as possible. Most configuration is validated at system startup and whenever a dynamic change is committed. However, due to limitations in JMX, custom MBeans cannot be validated until instances of those MBeans have been registered in the MBean server.

Sample Configurations for Different Harvestable Types

In [Listing 6-2](#), the `<harvested-type>` element in the `DIAG_MODULE.xml` configuration file specifies that the `ServerRuntimeMBean` is to be harvested. Because no `<harvested-instance>` sub-element is present, all instances of the type will be collected. However, because there is always only one instance of the server runtime MBean, there is no need to provide a specific list of instances. And because there are no `<harvested-attribute>` sub-elements present, all available attributes of the MBean are harvested for each of the two instances.

Listing 6-2 Sample Configuration for Collecting All Instances and All Attributes of a Type (in `DIAG_MODULE.xml`)

```
<harvested-type>
  <name>weblogic.management.runtime.ServerRuntimeMBean</name>
</harvested-type>
```

In [Listing 6-3](#), the `<harvested-type>` element in the `DIAG_MODULE.xml` configuration file specifies that the `WLDFHarvesterRuntimeMBean` is to be harvested. As above, because there is only one `WLDFHarvesterRuntimeMBean`, there is no need to provide a specific list of instances. The sub-element `<harvested-attribute>` specifies that only two of the available attributes of the `WLDFHarvesterRuntimeMBean` will be harvested: `TotalSamplingTime` and `CurrentSnapshotElapsedTime`.

Listing 6-3 Sample Configuration for Collecting Specified Attributes of All Instances of a Type (in `DIAG_MODULE.xml`)

```
<harvested-type>
  <name>weblogic.management.runtime.WLDFHarvesterRuntimeMBean</name>
```

Configuring the Harvester for Metric Collection

```
<harvested-attribute>TotalSamplingTime</harvested-attribute>
<harvested-attribute>CurrentSnapshotElapsedTime
</harvested-attribute>
</harvested-type>
```

In [Listing 6-4](#), the `<harvested-type>` element in the `DIAG_MODULE.xml` configuration file specifies that a single instance of a custom MBean type is to be harvested. Because this is a custom MBean, the type name is the implementation class. In this example, the two `<harvested-instance>` elements specify that only two instances of this type will be harvested. Each instance is specified using the canonical representation of its JMX `ObjectName`. Because no instances of `<harvested-attribute>` are specified, all attributes will be harvested.

Listing 6-4 Sample Configuration for Collecting Specified Attributes of a Specified Instance of a Type (in `DIAG_MODULE.xml`)

```
<harvested-type>
  <name>myMBeans.MySimpleStandard</name>
  <harvested-instance>myCustomDomain:Name=myCustomMBean1
</harvested-instance>
  <harvested-instance>myCustomDomain:Name=myCustomMBean2
</harvested-instance>
</harvested-type>
```

In [Listing 6-5](#), the `<harvested-type>` element in the `DIAG_MODULE.xml` configuration file specifies that the `ServerLifecycleRuntimeMBean` is to be harvested. The `<namespace>` attribute specifies that this is a `DomainRuntime` MBean, so this configuration will only be honored on the administration server (see the note in [“Harvesting from the DomainRuntime MBeanServer” on page 6-6](#)). The sub-element `<harvested-attribute>` specifies that only the `stateVal` attribute will be harvested.

Listing 6-5 Sample configuration for Collecting Specified Attributes of the ServerLifecycleMBean Type (in DIAG_MODULE.xml)

```
<harvested-type>
  <name>weblogic.management.runtime.ServerLifecycleRuntimeMBean</name>
  <namespace>DomainRuntime</namespace>
  <known-type>true</known-type>
  <harvested-attribute>StateVal</harvested-attribute>
</harvested-type>
```

Configuring the Harvester for Metric Collection

Configuring Watches and Notifications

The Watch and Notification component of the WebLogic Diagnostic Framework (WLDF) provides the means for monitoring server and application states and then sending notifications based on criteria set in the watches. Watches and notifications are configured as part of a diagnostic module targeted to one or more server instances in a domain.

Watches and notifications are described in the following sections:

- [“Watches and Notifications” on page 7-1](#)
- [“Overview of Watch and Notification Configuration” on page 7-2](#)
- [“Sample Watch and Notification Configuration” on page 7-4](#)

Watches and Notifications

A *watch* identifies a situation that you want to trap for monitoring or diagnostic purposes. You can configure watches to analyze log records, data events, and harvested metrics. A watch is specified as a watch rule, which includes:

- A watch rule expression
- An alarm setting
- One or more notification handlers

A *notification* is an action that is taken when a watch rule expression evaluates to `true`. WLDF supports the following types of notifications:

- Java Management Extensions (JMX)
- Java Message Service (JMS)
- Simple Mail Transfer Protocol (SMTP), for example, e-mail
- Simple Network Management Protocol (SNMP)
- Diagnostic Images

You must associate a watch with a notification for a useful diagnostic activity to occur, for example, to notify an administrator about specified states or activities in a running server.

Watches and notifications are configured separately from each other. A notification can be associated with multiple watches, and a watch can be associated with multiple notifications. This provides the flexibility to recombine and re-use watches and notifications, according to current needs.

Overview of Watch and Notification Configuration

A complete watch and notification configuration includes settings for one or more watches, one or more notifications, and any underlying configurations required for the notification media, for example, the SNMP configuration required for an SNMP-based notification.

The main elements required for configuring watches and notifications in a WLDF system resource descriptor file, `DIAG_MODULE.xml`, are shown in [Listing 7-1](#). As the listing shows, the base element for defining watches and notifications is `<watch-notification>`. Watches are defined in `<watch>` elements, and notifications are defined in elements named for each of the types of notification, for example `<jms-notification>`, `<jmx-notification>`, `<smtp-notification>`, and `<image-notification>`.

Listing 7-1 A Skeleton Watch and Notification Configuration (in `DIAG_MODULE.xml`)

```
<wldf-resource>
<!-- ----- Other system resource configuration elements ----- -->
  <watch-notification>
```

```

<log-watch-severity>
  <!-- Threshold severity for a log watch to be evaluated further
        (This can be narrowed further at the watch level.) -->
</log-watch-severity>

<!-- ----- Watch configuration elements: ----- -->

<watch>
  <!-- A watch rule -->
</watch>

<watch>
  <!-- A watch rule -->
</watch>

<!-- Any other watch configurations -->

<!-- ----- Notification configuration elements: ----- -->

<!-- The following notification configuration elements show one of each
type of supported notifications. However, not all types are
required in any one system resource configuration, and multiples
of any type are permitted. -->

<jms-notification>
  <!-- Configuration for a JMS-based notification; requires a
        corresponding JMS configuration via a jms-server element and a
        jms-system-resource element -->
</jms-notification>

<jmx-notification>
  <!-- Configuration for a JMX-based notification -->
</jmx-notification>

<smtp-notification>
  <!-- Configuration for an SMTP-based notification; requires a
        corresponding SMTP configuration via a mail-session element -->
</smtp-notification>

<snmp-notification>
  <!-- Configuration for an SNMP-based notification; requires a

```

```
        corresponding SNMP agent configuration via an snmp-agent
        element -->
    </snmp-notification>

    <image-notification>
        <!-- Configuration for an image-based notification -->
    </image-notification>

    <watch-notification>

<!-- ----- Other configuration elements ----- -->

</wldf-resource>
```

Note: While the notification media must be configured so they can be used by the notifications that depend on them, those configurations are not part of the configuration of the diagnostic module itself. That is, they are not configured in the `<wldf-resource>` element in the diagnostic module's configuration file.

Each watch and notification can be individually enabled and disabled by setting `<enabled>true</enabled>` or `<enabled>>false</enabled>` for the individual watch and/or notification. In addition, the entire watch and notification facility can be enabled and disabled by setting `<enabled>true</enabled>` or `<enabled>>false</enabled>` for all watches and notifications. The default value is `<enabled>true</enabled>`.

The `<watch-notification>` element contains a `<log-watch-severity>` sub-element, which affects how notifications are triggered by log-rule watches.

If the maximum severity level of the log messages that triggered the watch do not at least equal the provided severity level, then the resulting notifications are not fired. Note that this only applies to notifications fired by watches which have log rule types. Do not confuse this element with the `<severity>` element defined on watches. The `<severity>` element assigns a severity to the watch itself, whereas the `<log-watch-severity>` element controls which notifications are triggered by log-rule watches.

Sample Watch and Notification Configuration

A complete configuration for a set of watches and notifications in a diagnostic module is shown in [Listing 7-2](#). The details of this example are explained in the following two sections:

- [Chapter 8, “Configuring Watches”](#)

- Chapter 9, “Configuring Notifications”

Listing 7-2 Sample Watch and Notification Configuration (in *DIAG_MODULE.xml*)

```
<?xml version='1.0' encoding='UTF-8'?>
<wldf-resource xmlns="http://www.bea.com/ns/weblogic/weblogic-diagnostics"
  xmlns:xsi="http://www.w3.org/2001/XMLSchema-instance"
  xsi:schemaLocation="http://www.bea.com/ns/weblogic/weblogic-diagnostics
/1.1/weblogic-diagnostics.xsd">
  <name>mywldf1</name>

  <!-- Instrumentation must be configured and enabled for instrumentation
  watches -->

  <instrumentation>
    <enabled>true</enabled>
    <wldf-instrumentation-monitor>
      <name>DyeInjection</name>
      <description>Dye Injection monitor</description>
      <dye-mask xsi:nil="true"></dye-mask>
      <properties>ADDR1=127.0.0.1</properties>
    </wldf-instrumentation-monitor>
  </instrumentation>

  <!-- Harvesting does not have to be configured and enabled for harvester
  watches. However, configuring the Harvester can provide advantages;
  for example the data will be archived. -->

  <harvester>
    <name>mywldf1</name>
    <sample-period>20000</sample-period>
    <harvested-type>
      <name>weblogic.management.runtime.ServerRuntimeMBean</name>
    </harvested-type>
    <harvested-type>
      <name>weblogic.management.runtime.WLDFHarvesterRuntimeMBean</name>
    </harvested-type>
  </harvester>
```

Configuring Watches and Notifications

```
<!-- All watches and notifications are defined under the
      watch-notification element -->

<watch-notification>
  <enabled>true</enabled>
  <log-watch-severity>Info</log-watch-severity>

  <!-- A harvester watch configuration -->

  <watch>
    <name>myWatch</name>
    <enabled>true</enabled>
    <rule-type>Harvester</rule-type>
    <rule-expression>${com.bea:Name=myserver,Type=ServerRuntime//Sockets
OpenedTotalCount} &gt;= 1</rule-expression>
    <alarm-type>AutomaticReset</alarm-type>
    <alarm-reset-period>60000</alarm-reset-period>
    <notification>myMailNotif,myJMXNotif,mySNMPNotif</notification>
  </watch>

  <!-- An instrumentation watch configuration -->

  <watch>
    <name>myWatch2</name>
    <enabled>true</enabled>
    <rule-type>EventData</rule-type>
    <rule-expression>
      (MONITOR LIKE 'JDBC_After_Execute') AND
      (DOMAIN = 'MedRecDomain') AND
      (SERVER = 'medrec-adminServer') AND
      ((TYPE = 'ThreadDumpAction') OR (TYPE = TraceElapsedTimeAction')) AND
      (SCOPE = 'MedRecEAR')
    </rule-expression>
    <notification>JMXNotifInstr</notification>
  </watch>

  <!-- A log watch configuration -->

  <watch>
    <name>myLogWatch</name>
    <rule-type>Log</rule-type>
    <rule-expression>MSGID='BEA-000360'</rule-expression>
```

```
    <severity>Info</severity>
    <notification>myMailNotif2</notification>
</watch>

<!-- A JMX notification -->
<jmx-notification>
  <name>myJMXNotif</name>
</jmx-notification>

<!-- Two SMTP notifications -->
<smtp-notification>
  <name>myMailNotif</name>
  <enabled>true</enabled>
  <mail-session-jndi-name>myMailSession</mail-session-jndi-name>
  <subject>This is a harvester alert</subject>
  <recipient>username@emailservice.com</recipient>
</smtp-notification>

<smtp-notification>
  <name>myMailNotif2</name>
  <enabled>true</enabled>
  <mail-session-jndi-name>myMailSession</mail-session-jndi-name>
  <subject>This is a log alert</subject>
  <recipient>username@emailservice.com</recipient>
</smtp-notification>

<!-- An SNMP notification -->
<snmp-notification>
  <name>mySNMPNotif</name>
  <enabled>true</enabled>
</snmp-notification>

</watch-notification>
</wldf-resource>
```

Configuring Watches and Notifications

Configuring Watches

The following sections describe the types of watches and their configuration options:

- [“Types of Watches” on page 8-1](#)
- [“Configuration Options Shared by All Types of Watches” on page 8-2](#)
- [“Configuring Harvester Watches” on page 8-3](#)
- [“Configuring Log Watches” on page 8-6](#)
- [“Configuring Instrumentation Watches” on page 8-7](#)
- [“Defining Watch Rule Expressions” on page 8-7](#)

Types of Watches

WLDF provides three main types of watches, based on what the watch can monitor:

- **Harvester** watches monitor the set of harvestable MBeans in the local runtime MBean server.
- **Log** watches monitor the set of messages generated into the server log.
- **Instrumentation** (or Event Data) watches monitor the set of events generated by the WLDF Instrumentation component.

In the WLDF system resource configuration file for a diagnostic module, each type of watch is defined in a `<rule-type>` element, which is a child of `<watch>`. For example:

```
<watch>
  <rule-type>Harvester</rule-type>
  <!-- Other configuration elements -->
</watch>
```

Watches with different rule types differ in two ways:

- The rule syntax for specifying the conditions being monitored are unique to the type.
- Log and Instrumentation watches are triggered in real time, whereas Harvester watches are triggered only after the current harvest cycle completes.

Configuration Options Shared by All Types of Watches

All watches share certain configuration options:

- Watch rule expression

In the diagnostic module configuration file, watch rule expressions are defined in `<rule-expression>` elements.

A watch rule expression is a logical expression that specifies what significant events the watch is to trap. For information about the query language you use to define watch rules, including the syntax available for each type of watch rule, see [Appendix A, “WLDF Query Language.”](#)

- Notifications associated with the watch

In the diagnostic module configuration file, notifications are defined in `<notification>` elements.

Each watch can be associated with one or more notifications that are triggered whenever the watch evaluates to `true`. The content of this element is a comma-separated list of notifications. For information about configuring notifications, see [Chapter 9, “Configuring Notifications.”](#)

- Alarm options

In the diagnostic module configuration file, alarm options are set using `<alarm-type>` and `<alarm-reset-period>` elements.

Watches can be specified to trigger repeatedly, or to trigger once, when a condition is met. For watches that trigger repeatedly, you can optionally define a minimum time between occurrences. The `<alarm-type>` element defines whether a watch automatically repeats, and, if so, how often. A value of `none` causes the watch to trigger whenever possible. A value of `AutomaticReset` also causes the watch to trigger whenever possible, except that subsequent occurrences cannot occur any sooner than the millisecond interval specified in the `<alarm-reset-period>`. A value of `ManualReset` causes the watch to fire a single time. After it fires, you must manually reset it to fire again. For example, you can use the `WatchNotificationRuntimeMBean` to reset a manual watch. The default for `<alarm-type>` is `None`.

- Severity options

Watches contain a severity value which is passed through to the recipients of notifications. The permissible severity values are as defined in the logging subsystem. The severity value is specified using sub-element `<severity>`. The default is `Notice`.

- Enabled options

Each watch can be individually enabled and disabled, using the sub-element `<enabled>`. When disabled, the watch does not trigger and corresponding notifications do not fire. If the more generic watch/notification flag is disabled, it causes all individual watches to be effectively disabled (that is, the value of this flag on a specific watch is ignored).

Configuring Harvester Watches

A Harvester watch can monitor any runtime MBean in the local runtime MBean server.

Note: If you define a watch rule to monitor an MBean (or MBean attributes) that the Harvester is not configured to harvest, the watch *will* work. The Harvester will “implicitly” harvest values to satisfy the requirements set in the defined watch rules. However, data harvested in this way (that is, implicitly for a watch) will not be archived. See [Chapter 6, “Configuring the Harvester for Metric Collection,”](#) for more information about the Harvester.

Harvester watches are triggered in response to a harvest cycle. So, for Harvester watches, the Harvester sample period defines a time interval between when a situation is identified and when it can be reported through a notification. On average, the delay is `SamplePeriod/2`.

[Listing 8-1](#), shows a configuration example of a Harvester watch that monitors several runtime MBeans. When the watch rule (defined in the `<rule-expression>` element) evaluates to `true`, six different notifications are sent: a JMX notification, an SMTP notification, an SNMP notification, an image notification, and JMS notifications for both a topic and a queue.

The watch rule is a logical expression composed of four Harvester variables. The rule has the form:

```
( ( A >= 100 ) AND ( B > 0 ) ) OR C OR D.equals("active")
```

Each variable is of the form:

```
{entityName}/{attributeName}
```

where {entityName} is the JMX ObjectName as registered in the runtime MBean server or the type name as defined by the Harvester, and where {attributeName} is the name of an attribute defined on that MBean type.

Note: The comparison operators are qualified in order to be valid in XML.

Listing 8-1 Sample Harvester Watch Configuration (in *DIAG_MODULE.xml*)

```
<wldf-resource xmlns="http://www.bea.com/ns/weblogic/weblogic-diagnostics"
  xmlns:xsi="http://www.w3.org/2001/XMLSchema-instance"
  xsi:schemaLocation="http://www.bea.com/ns/weblogic/weblogic-diagnostics
/1.1/weblogic-diagnostics.xsd">
  <name>mywldf1</name>
  <harvester>
    <!-- Harvesting does not have to be configured and enabled for harvester
      watches. However, configuring the Harvester can provide advantages;
      for example the data will be archived. -->
    <harvested-type>
      <name>myMBeans.MySimpleStandard</name>
      <harvested-instance>myCustomDomain:Name=myCustomMBean1
</harvested-instance>
      <harvested-instance>myCustomDomain:Name=myCustomMBean2
</harvested-instance>
    </harvested-type>
    <!-- Other Harvester configuration elements -->
  </harvester>
  <watch-notification>
    <watch>
      <name>simpleWebLogicMBeanWatchRepeatingAfterWait</name>
```



```

<enabled>true</enabled>
<rule-type>Harvester</rule-type>
<rule-expression>
  (${mydomain:Name=WLDHHarvesterRuntime,ServerRuntime=myserver,Type=
  WLDHHarvesterRuntime,WLDFRuntime=WLDFRuntime//TotalSamplingTime}
    &gt;= 100
    AND
    ${mydomain:Name=myserver,Type=
      ServerRuntime//OpenSocketsCurrentCount} &gt; 0)
    OR
    ${mydomain:Name=WLDHWatchNotificationRuntime,ServerRuntime=
      myserver,Type=WLDHWatchNotificationRuntime,
      WLDFRuntime=WLDFRuntime//Enabled} = true
    OR
    ${myCustomDomain:Name=myCustomMBean3//State} =
      'active')
</rule-expression>
<severity>Warning</severity>
<alarm-type>AutomaticReset</alarm-type>
<alarm-reset-period>10000</alarm-reset-period>
<notification>myJMXNotif,myImageNotif,
  myJMSTopicNotif,myJMSQueueNotif,mySNMPNotif,
  mySMTPNotif</notification>
</watch>
<!-- Other watch-notification configuration elements -->
</watch-notification>
</wldf-resource>

```

This watch uses an alarm type of `AutomaticReset`, which means that it may be triggered repeatedly, provided that the last time it was triggered was longer than the interval set as the alarm reset period (in this case 10000 milliseconds).

The severity level provided, `warning`, has no effect on the triggering of the watch, but will be passed on through the notifications.

Configuring Log Watches

Use Log watches to monitor the occurrence of specific messages and/or strings in the server log. Watches of this type are triggered as a result of a log message containing the specified data being issued.

An example configuration for a log watch is shown in [Listing 8-2](#).

Listing 8-2 Sample Configuration for a Log Watch (in *DIAG_MODULE.xml*)

```
<wldf-resource xmlns="http://www.bea.com/ns/weblogic/weblogic-diagnostics"
  xmlns:xsi="http://www.w3.org/2001/XMLSchema-instance"
  xsi:schemaLocation="http://www.bea.com/ns/weblogic/90/diagnostics.xsd">
  <name>mywldf1</name>

  <watch-notification>
    <enabled>true</enabled>
    <log-watch-severity>Info</log-watch-severity>

    <watch>
      <name>myLogWatch</name>
      <rule-type>Log</rule-type>
      <rule-expression>MSGID='BEA-000360'</rule-expression>
      <severity>Info</severity>
      <notification>myMailNotif2</notification>
    </watch>

    <smtp-notification>
      <name>myMailNotif2</name>
      <enabled>true</enabled>
      <mail-session-jndi-name>myMailSession</mail-session-jndi-name>
      <subject>This is a log alert</subject>
      <recipient>username@emailservice.com</recipient>
    </smtp-notification>
  </watch-notification>
</wldf-resource>
```

Configuring Instrumentation Watches

You use Instrumentation watches to monitor the events from the WLDF Instrumentation component. Watches of this type are triggered as a result of the event being posted.

[Listing 8-3](#) shows an example configuration for an Instrumentation watch.

Listing 8-3 Sample Configuration for an Instrumentation Watch (in *DIAG_MODULE.xml*)

```

<watch-notification>
  <watch>
    <name>myInstWatch</name>
    <enabled>true</enabled>
    <rule-type>EventData</rule-type>
    <rule-expression>
      (PAYLOAD > 100000000) AND (MONITOR = 'Servlet_Around_Service')
    </rule-expression>
    <alarm-type xsi:nil="true"></alarm-type>
    <notification>mySMTPNotification</notification>
  </watch>

  <smtp-notification>
    <name>mySMTPNotification</name>
    <enabled>true</enabled>
    <mail-session-jndi-name>myMailSession</mail-session-jndi-name>
    <subject xsi:nil="true"></subject>
    <body xsi:nil="true"></body>
    <recipient>username@emailservice.com</recipient>
  </smtp-notification>
</watch-notification>

```

Defining Watch Rule Expressions

A watch rule expression encapsulates all information necessary for specifying a rule. For documentation on the query language you use to define watch rules, see [Appendix A, “WLDF Query Language.”](#)

Configuring Watches

Configuring Notifications

The following sections describe the types of notifications and their configuration options:

- [“Types of Notifications” on page 9-1](#)
- [“Configuring JMX Notifications” on page 9-2](#)
- [“Configuring JMS Notifications” on page 9-3](#)
- [“Configuring SNMP Notifications” on page 9-4](#)
- [“Configuring SMTP Notifications” on page 9-6](#)
- [“Configuring Image Notifications” on page 9-7](#)

Types of Notifications

A *notification* is an action that is triggered when a watch rule evaluates to `true`. WLDF supports four types of diagnostic notifications, based on the delivery mechanism: Java Management Extensions (JMX), Java Message Service (JMS), Simple Mail Transfer Protocol (SMTP), and Simple Network Management Protocol (SNMP). You can also create a notification that generates a diagnostic image.

In the configuration file for a diagnostic module, the different types of notifications are identified by these elements:

- `<jmx-notification>`
- `<jms-notification>`

- <snmp-notification>
- <smtp-notification>
- <image-notification>

These notification types all have <name> and <enabled> configuration options. The value of <name> is used as the value in a <notification> element for a watch, to map the watch to its corresponding notification(s). The <enabled> element, when set to true, enables that notification. In other words, the notification is fired when an associated watch evaluates to true. Other than <name> and <enabled>, each notification type is unique.

Note: To define notifications programmatically, use [weblogic.diagnostics.watch.WatchNotification](#).

Configuring JMX Notifications

For each defined JMX notification, WLDF issues JMX events (notifications) whenever an associated watch is triggered. Applications can register a notification listener with the server's `WLDFWatchJMXNotificationRuntimeMBeans` to receive all notifications and filter the provided output. You can also specify a JMX “notification type” string that a JMX client can use as a filter.

[Listing 9-1](#) shows an example of a JMX notification configuration.

Listing 9-1 Example Configuration for a JMX Notification

```
<wldf-resource xmlns="http://www.bea.com/ns/weblogic/weblogic-diagnostics"
  xmlns:xsi="http://www.w3.org/2001/XMLSchema-instance"
  xsi:schemaLocation="http://www.bea.com/ns/weblogic/weblogic-diagnostics
/1.1/weblogic-diagnostics.xsd">
  <name>mywldf1</name>
  <watch-notification>
    <!-- One or more watch configurations -->
    <jmx-notification>
      <name>myJMXNotif</name>
      <enabled>true</enabled>
    </jmx-notification>
    <!-- Other notification configurations -->
  </watch-notification>
```

```
</wldf-resource>
```

Here is an example of a JMX notification:

```
Notification name:    myjmx called. Count= 42.
Watch severity:      Notice
Watch time:          Jul 19, 2005 3:40:38 PM EDT
Watch ServerName:    myserver
Watch RuleType:      Harvester
Watch Rule:
    ${com.bea:Name=myserver,Type=ServerRuntime//OpenSocketsCurrentCount} > 1
Watch Name:          mywatch
Watch DomainName:    mydomain
Watch AlarmType:     None
Watch AlarmResetPeriod: 10000
```

Configuring JMS Notifications

JMS notifications are used to post messages to JMS topics and/or queues in response to the triggering of an associated watch. In the system resource configuration file, the elements `<destination-jndi-name>` and `<connection-factory-jndi-name>` define how the message is to be delivered.

[Listing 9-2](#) shows two JMS notifications that cause JMS messages to be sent through the provided topics and queues using the specified connection factory. For this to work properly, JMS must be properly configured in the `config.xml` configuration file for the domain, and the JMS resource must be targeted to this server.

Listing 9-2 Example JMS Notifications

```
<wldf-resource xmlns="http://www.bea.com/ns/weblogic/weblogic-diagnostics"
  xmlns:xsi="http://www.w3.org/2001/XMLSchema-instance"
```

Configuring Notifications

```
xsi:schemaLocation="http://www.bea.com/ns/weblogic/weblogic-diagnostics
/1.1/weblogic-diagnostics.xsd">
<name>mywldf1</name>
<watch-notification>
  <!-- One or more watch configurations -->

  <jms-notification>
    <name>myJMSTopicNotif</name>
    <destination-jndi-name>MyJMSTopic</destination-jndi-name>
    <connection-factory-jndi-name>weblogic.jms.ConnectionFactory
      </connection-factory-jndi-name>
  </jms-notification>

  <jms-notification>
    <name>myJMSQueueNotif</name>
    <destination-jndi-name>MyJMSQueue</destination-jndi-name>
    <connection-factory-jndi-name>weblogic.jms.ConnectionFactory
      </connection-factory-jndi-name>
  </jms-notification>

  <!-- Other notification configurations -->
</watch-notification>
</wldf-resource>
```

The content of the notification message gives details of the watch and notification.

Configuring SNMP Notifications

Simple Network Management Protocol (SNMP) notifications are used to post SNMP traps in response to the triggering of an associated watch. To define an SNMP notification you only have to provide a notification name, as shown in [Listing 9-3](#). Generated traps contain the names of both the watch and notification that caused the trap to be generated. For an SNMP trap to work properly, SNMP must be properly configured in the `config.xml` configuration file for the domain.

Listing 9-3 An Example Configuration for an SNMP Notification

```

<wldf-resource xmlns="http://www.bea.com/ns/weblogic/weblogic-diagnostics"
  xmlns:xsi="http://www.w3.org/2001/XMLSchema-instance"
  xsi:schemaLocation="http://http://www.bea.com/ns/weblogic/weblogic-diagnostics/1.1/weblogic-diagnostics.xsd">

  <name>mywldf1</name>

  <watch-notification>
    <!-- One or more watch configurations -->

    <snmp-notification>
      <name>mySNMPNotif</name>
    </snmp-notification>

    <!-- Other notification configurations -->
  </watch-notification>
</wldf-resource>

```

The trap resulting from the SNMP notification configuration shown in [Listing 9-3](#) is of type 85. It contains the following values (configured values are shown in angle brackets “<>”):

```

.1.3.6.1.4.1.140.625.100.5   timestamp (e.g. Dec 9, 2004 6:46:37 PM
                           EST)
.1.3.6.1.4.1.140.625.100.145  domainName (e.g. mydomain")
.1.3.6.1.4.1.140.625.100.10   serverName (e.g. myserver)
.1.3.6.1.4.1.140.625.100.120  <severity> (e.g. Notice)
.1.3.6.1.4.1.140.625.100.105  <name> [of watch] (e.g.
                           simpleWebLogicMBeanWatchRepeatingAfterWait)
.1.3.6.1.4.1.140.625.100.110  <rule-type> (e.g. HarvesterRule)
.1.3.6.1.4.1.140.625.100.115  <rule-expression>
.1.3.6.1.4.1.140.625.100.125  values which caused rule to
                           fire (e.g..State =
                           null,weblogic.management.runtime.WLDFHarvesterRuntimeMBean.
                           TotalSamplingTime = 886,.Enabled =
                           null,weblogic.management.runtime.ServerRuntimeMBean.
OpenSocketsCurrentCount = 1,)

```

```
.1.3.6.1.4.1.140.625.100.130 <alarm-type> (e.g. None)
.1.3.6.1.4.1.140.625.100.135 <alarm-reset-period> (e.g. 10000)
.1.3.6.1.4.1.140.625.100.140 <name> [of notification]
                               (e.g.mySNMPNotif)
```

Configuring SMTP Notifications

Simple Mail Transfer Protocol (SMTP) notifications are used to send messages (e-mail) over the SMTP protocol in response to the triggering of an associated watch. To define an SMTP notification, first configure the SMTP session. That configuration is persisted in the `config.xml` configuration file for the domain. In `DIAG_MODULE.xml`, you provide the configured SMTP session using sub-element `<mail-session-jndi-name>`, and provide a list of at least one recipient using sub-element `<recipients>`. An optional subject and/or body can be provided using sub-elements `<subject>` and `<body>` respectively. If these are not provided, they will be defaulted.

[Listing 9-4](#) shows an SMTP notification that causes an SMTP (e-mail) message to be distributed through the configured SMTP session, to the configured recipients. In this notification configuration, a custom subject and body are provided. If a subject and/or a body are not specified, defaults are provided, showing details of the watch and notification.

Listing 9-4 Sample Configuration for SMTP Notification (in `DIAG_MODULE.xml`)

```
<wldf-resource xmlns="http://www.bea.com/ns/weblogic/weblogic-diagnostics"
  xmlns:xsi="http://www.w3.org/2001/XMLSchema-instance"
  xsi:schemaLocation="http://www.bea.com/ns/weblogic/weblogic-diagnostics
/1.1/weblogic-diagnostics.xsd">
  <name>mywldf1</name>
  <watch-notification>
    <!-- One or more watch configurations -->
    <smtp-notification>
      <name>mySMTPNotif</name>
      <mail-session-jndi-name>MyMailSession</mail-session-jndi-name>
      <subject>Critical Problem!</subject>
      <body>A system issue occurred. Call Winston ASAP.
        Reference number 81767366662AG-USA23.</body>
```

```

    <recipients>administrator@myCompany.com</recipients>
  </smtp-notification>

  <!-- Other notification configurations -->

</watch-notification>

</wldf-resource>

```

The content of the notification message gives details of the watch and notification.

Configuring Image Notifications

An image notification causes a diagnostic image to be generated in response to the triggering of an associated watch. You can configure two options for image notifications: a directory and a lockout period.

The directory name indicates where images will be generated. The lockout period determines the the number of seconds that must elapse before a new image can be generated after the last one. This is useful for limiting the number of images that will be generated when there is a sequence of server failures and recoveries

You can specify the directory name relative to the *DOMAIN_NAME*\servers*SERVER_NAME*, directory where *DOMAIN_NAME* is the name of the domain's home directory and *SERVER_NAME* is the name of the server. The default directory is

DOMAIN_NAME\servers*SERVER_NAME*\logs\diagnostic-images.

Image file names are generated using the current timestamp (for example, diagnostic_image_myserver_2005_08_09_13_40_34.zip), so a notification can fire many times, resulting in a separate image file each time.

The configuration is persisted in the *DIAG_MODULE.xml* configuration file. [Listing 9-5](#) shows an image notification configuration that specifies that the lockout time will be two minutes and that the image will be generated to the *DOMAIN_NAME*\servers*SERVER_NAME*\images directory.

Listing 9-5 Sample Configuration for Image Notification (in *DIAG_MODULE.xml*)

```

<wldf-resource xmlns="http://www.bea.com/ns/weblogic/weblogic-diagnostics"
  xmlns:xsi="http://www.w3.org/2001/XMLSchema-instance"

```

Configuring Notifications

```
xsi:schemaLocation="http://www.bea.com/ns/weblogic/weblogic-diagnostics
/1.1/weblogic-diagnostics.xsd">
<name>mywldf1</name>
<watch-notification>
  <!-- One or more watch configurations -->
  <image-notification>
    <name>myImageNotif</name>
    <enabled>true</enabled>
    <image-lockout>2</image-lockout>
    <image-directory>images</image-directory>
  </image-notification>
  <!-- Other notification configurations -->
</watch-notification>
</wldf-resource>
```

For more information about Diagnostic Images, see [Chapter 4, “Configuring and Capturing Diagnostic Images.”](#)

Configuring Instrumentation

The Instrumentation component of the WebLogic Diagnostic Framework (WLDF) provides a mechanism for adding diagnostic code to WebLogic Server[®] instances and the applications running on them. The key features provided by WLDF Instrumentation are:

- **Diagnostic monitors.** A *diagnostic monitor* is a dynamically manageable unit of diagnostic code which is inserted into server or application code at specific locations. You define monitors by scope (system or application) and type (standard, delegating, or custom).
- **Diagnostic actions.** A *diagnostic action* is the action a monitor takes when it is triggered during program execution.
- **Diagnostic context.** A *diagnostic context* is contextual information, such as unique request identifier and flags which indicate presence of certain request properties such as originating IP address or user identity. The diagnostic context provides a means for tracking program execution and for controlling when monitors trigger their diagnostic actions. See [Chapter 11, “Configuring the DyeInjection Monitor to Manage Diagnostic Contexts.”](#)

WLDF provides a library of predefined diagnostic monitors and actions. You can also create application-scoped custom monitors, where you control the locations where diagnostic code is inserted in the application.

Instrumentation is described in the following sections:

- [“Concepts and Terminology” on page 10-2](#)
- [“Instrumentation Configuration Files” on page 10-5](#)

- [“XML Elements Used for Instrumentation”](#) on page 10-7
- [“Configuring Server-Scoped Instrumentation”](#) on page 10-15
- [“Configuring Application-Scoped Instrumentation”](#) on page 10-17

Concepts and Terminology

This section introduces instrumentation concepts and terminology.

- [“Instrumentation Scope”](#) on page 10-2
- [“Configuration and Deployment”](#) on page 10-2
- [“Joinpoints, Pointcuts, and Diagnostic Locations”](#) on page 10-3
- [“Diagnostic Monitor Types”](#) on page 10-3
- [“Diagnostic Actions”](#) on page 10-5

Instrumentation Scope

You can provide instrumentation services at the system level (servers and clusters) and at the application level. Many concepts, services, configuration options, and implementation features are the same for both. However, there are differences, and they are discussed throughout this documentation. The term “server-scoped instrumentation” refers to instrumentation configuration and features specific to WebLogic Server instances and clusters.

“Application-scoped instrumentation” refers to configuration and features specific to applications deployed on WebLogic servers. The scope is built in to each diagnostic monitor; you cannot modify a monitor’s scope.

Configuration and Deployment

Server-scoped instrumentation for a server or cluster is configured and deployed as part of a diagnostic module, an XML configuration file located in the `DOMAIN_NAME/config/diagnostics` directory, and linked from `config.xml`.

Application-scoped instrumentation is also configured and deployed as a diagnostics module, in this case an XML configuration file named `weblogic-diagnostics.xml` which is packaged with the application archive in the `ARCHIVE_PATH/META-INF` directory for the deployed application.

Joinpoints, Pointcuts, and Diagnostic Locations

Instrumentation code is inserted into (or “woven” into) server and application code at precise locations. The following terms are used to describe these locations:

- A *joinpoint* is a specific location in a class, for example the entry and/or exit point of a method or a call site within a method.
- A *pointcut* is an expression that specifies a set of joinpoints, for example all methods related to scheduling, starting, and executing work items. The XML element used to describe a pointcut is `<pointcut>`. Pointcuts are described in [“Defining Pointcuts for Custom Monitors” on page 10-22](#).
- A *diagnostic location* is the position relative to a joinpoint where the diagnostic activity will take place. Diagnostic locations are *before*, *after*, and *around*. The XML element used to describe a diagnostic location is `<location-type>`.

Diagnostic Monitor Types

A diagnostic monitor is categorized by its scope and its type. The scope is either server-scoped or application-scoped. The type is determined by the monitor’s pointcut, diagnostic location, and actions. For example, `Servlet_Around_Service` is an application-scoped delegating monitor, which can be used to trigger diagnostic actions at the entry to and at the exit of certain servlet and JSP methods.

There are three types of instrumentation diagnostic monitors:

- A *standard monitor* performs specific, predefined diagnostic actions at specific, predefined pointcuts and locations. These actions, pointcuts, and locations are hardcoded in the monitor. You can enable or disable the monitor but you cannot modify its behavior.

The only standard server-scoped monitor is the `DyeInjection` monitor, which you can use to create diagnostic context and to configure dye injection at the server level. For more information, see [Chapter 11, “Configuring the DyeInjection Monitor to Manage Diagnostic Contexts.”](#)

The only standard application-scoped monitor is `HttpSessionDebug`, which you can use to inspect an `HTTP Session` object.

- A *delegating monitor* has its scope, pointcuts, and locations hardcoded in the monitor, but you select the actions the monitor will perform. In that sense, the monitor delegates its actions to the ones you select. Delegating monitors are either server-scoped or application-scoped.

A delegating monitor by itself is incomplete. In order for a delegating monitor to perform any useful work, you must assign at least one action to the monitor.

Not all actions are compatible with all monitors. When you configure a delegating monitor from the Administration Console, you can choose only those actions that are appropriate for the selected monitor. If you are using WLST or editing a descriptor file manually, you must make sure that the actions are compatible with the monitors. Validation is performed when the XML file is loaded at deployment time.

See [Appendix B, “WLDF Instrumentation Library,”](#) for a list of the delegating monitors and actions provided by the WLDF Instrumentation Library.

- A *custom monitor* is a special case of a delegating monitor, which is available only for application-scoped instrumentation, and does not have a predefined pointcut or location.

You assign a name to a custom monitor, define the pointcut and the diagnostics location the monitor will use, and then assign actions from the set of predefined diagnostic actions. The `<pointcut>` and `<location type>` elements are mandatory for a custom monitor.

[Table 10-1](#) summarizes the differences among the types of monitors.

Table 10-1 Diagnostic Monitor Types

Monitor Type	Scope	Pointcut	Location	Action
Standard monitor	Server	Fixed	Fixed	Fixed
Delegating monitor	Server or Application	Fixed	Fixed	Configurable
Custom monitor	Application	Configurable	Configurable	Configurable

You can restrict when a diagnostic action is triggered by setting a *dye mask* on a monitor. This mask determines which dye flags in the diagnostic context trigger actions. See [“<wldf-instrumentation-monitor> XML Elements” on page 10-9](#) for information on setting a dye mask for a monitor.

Note: Diagnostic context, dye injection, and dye filtering are described in [Chapter 11, “Configuring the DyeInjection Monitor to Manage Diagnostic Contexts.”](#)

Diagnostic Actions

Diagnostic actions execute diagnostic code that is appropriate for the associated delegating or custom monitor (standard monitors have predefined actions). In order for a delegating or custom monitor to perform any useful work, you must configure at least one action for the monitor.

The WLDF diagnostics library provides the following actions, which you can attach to a monitor by including the action's name in an `<action>` element of the `DIAG_MODULE.xml` configuration file:

- `DisplayArgumentsAction`
- `StackDumpAction`
- `ThreadDumpAction`
- `TraceAction`
- `TraceElapsedTimeAction`
- `MethodInvocationStatisticsAction`

Actions must be correctly matched with monitors. For example, the `TraceElapsedTime` action is compatible with a delegating or custom monitor whose diagnostic location type is `around`. See [Appendix B, “WLDF Instrumentation Library.”](#) for more information.

Instrumentation Configuration Files

Instrumentation is configured as part of a diagnostics descriptor, an XML configuration file, whose name and location depend on whether you are implementing system-level (server-scoped) or application-level (application-scoped) instrumentation:

- System-level instrumentation configuration is stored in diagnostics descriptor(s) in the following directory:

`DOMAIN_NAME/config/diagnostics`

This directory can contain multiple system-level diagnostic descriptor files. Filenames are arbitrary but must be terminated with `.xml` (`myDiag.xml` is a valid filename). Each file can contain configuration information for one or more of the deployable diagnostic components: Harvester, Instrumentation, or Watch and Notification. An `<instrumentation>` section in a descriptor file can configure one or more diagnostic monitors. Server-scoped instrumentation can be enabled, disabled, and reconfigured without restarting the server.

Only one WLDF system resource (and hence one system-level diagnostics descriptor file) can be active at a time for a server (or cluster). The active descriptor is linked and targeted from the following configuration file:

```
DOMAIN_NAME/config/config.xml
```

For more information about configuring diagnostic system modules, see “[Configuring Diagnostic System Modules](#)” on page 3-5. For general information about the creation, content, and parsing of configuration files in WebLogic Server, see [Understanding Domain Configuration](#).

- Application-level instrumentation configuration is packaged within an application’s archive in the following location:

```
META-INF/weblogic-diagnostics.xml
```

Because instrumentation is the only diagnostics component that is deployable to applications, this descriptor can contain only instrumentation configuration information.

Note: For instrumentation to be available for an application, instrumentation must be enabled on the server to which the application is deployed. (Server-scoped instrumentation is enabled and disabled in the `<instrumentation>` element of the diagnostics descriptor for the server.)

You can enable and disable diagnostic monitors without redeploying an application. However, you may have to redeploy the application after modifying other instrumentation features, for example defining pointcuts or adding or removing monitors. Whether you have to redeploy depends on how you configure the instrumentation and how you deploy the application. There are three options:

- Define and change the instrumentation configuration for the application directly, without using a JSR-88 deployment plan
- Configure and deploy the application using a deployment plan that has placeholders for instrumentation settings
- Enable the hot-swap feature when starting the server, and deploy using a deployment plan that has placeholders for instrumentation settings

For more information about these choices, see “[Using Deployment Plans for Dynamically Controlling Instrumentation Configuration](#)” on page 13-3.

For more information about deploying and modifying diagnostic application modules, see [Chapter 13, “Deploying WLDF Application Modules.”](#)

The diagnostics XML schema is located at:

<http://www.bea.com/ns/weblogic/weblogic-diagnostics/1.1/weblogic-diagnostics.xsd>

Each diagnostics descriptor file must begin with the following lines:

```
<wldf-resource xmlns="http://www.bea.com/ns/weblogic/weblogic-diagnostics"
  xmlns:xsi="http://www.w3.org/2001/XMLSchema-instance">
```

For an overview of WLDF resource configuration, see [Chapter 3, “Understanding WLDF Configuration.”](#)

XML Elements Used for Instrumentation

This section provides descriptor fragments and tables that summarize information about the XML elements used to configure instrumentation and the instrumentation diagnostic monitors.

- “[<Instrumentation> XML Elements](#)” on page 10-7 describes the top-level elements used within an `<instrumentation>` element.
- “[<wldf-instrumentation-monitor> XML Elements](#)” on page 10-9 describes the elements used within an `<wldf-instrumentation-monitor>` element.
- “[Mapping <wldf-instrumentation-monitor> XML Elements to Monitor Types](#)” on page 10-14 summarizes which instrumentation elements apply to which monitors.

<Instrumentation> XML Elements

[Table 10-2](#) describes the `<instrumentation>` elements in the `DIAG_MODULE.xml` file. The following configuration fragment illustrates the use of those elements:

```
<wldf-resource>
  <name>MyDiagnosticModule</name>
  <instrumentation>
    <enabled>true</enabled>
    <!-- The following <include> element would apply only to an
         application-scoped Instrumentation descriptor -->
    <include>foo.bar.com.*</include>
    <!-- &lt;wldf-instrumentation-monitor&gt; elements to define diagnostic
         monitors for this diagnostic module -->
  </instrumentation>
  <!-- Other elements to configure this diagnostic module -->
</wldf-resource>
```

Table 10-2 <instrumentation> XML Elements in the *DIAG_MODULE.xml* Configuration File

Element	Description
<instrumentation>	The element that begins an instrumentation configuration.
<enabled>	<p>If <code>true</code>, instrumentation is enabled. If <code>false</code>, no instrumented code will be inserted in classes in this instrumentation scope, and all diagnostic monitors within this scope are disabled. The default value is <code>false</code>.</p> <p>You must enable instrumentation at the server level to enable instrumentation for the server and for any applications deployed to it. You must further enable instrumentation at the application level to enable instrumentation for the application (that is, in addition to enabling the server-scoped instrumentation).</p>

Table 10-2 <instrumentation> XML Elements in the *DIAG_MODULE.xml* Configuration File

<include>	<p>An optional element specifying the list of classes where instrumented code can be inserted. Wildcards (*) are supported. You can specify multiple <include> elements. If specified, a class must satisfy an <include> pattern for it to be instrumented.</p> <p>Applies only to application-scoped instrumentation. Any specified <include> or <exclude> patterns are applied to the application scope as a whole.</p> <p>Note: You can also specify <include> and <exclude> patterns for specific diagnostic monitors. See the entries for <include> and <exclude> in Table 10-3.</p> <p>As classes are loaded, they must pass an include/exclude pattern check before any instrumentation code is inserted. Even if a class passes the include/exclude pattern checks, whether or not it is instrumented depends on the diagnostic monitors included in the configuration descriptor. An application-scoped delegating monitor from the library has its own predefined classes and pointcuts. A custom monitor specifies its own pointcut expression. Therefore a class can pass the include/exclude checks and still not be instrumented.</p> <p>Note: Instrumentation is inserted in applications at class load time. A large application that is loaded often may benefit from a judicious use of <include> and/or <exclude> elements. You can probably ignore these elements for small applications or for medium-to-large applications that are loaded infrequently.</p>
<exclude>	<p>An optional element specifying the list of classes where instrumented code cannot be inserted. Wildcards (*) are supported. You can specify multiple <exclude> elements. If specified, classes satisfying an <exclude> pattern are not instrumented.</p> <p>Applies only to application-scoped instrumentation. See the <include> description, above.</p>

<wldf-instrumentation-monitor> XML Elements

Diagnostic monitors are defined in <wldf-instrumentation-monitor> elements, which are children of the <instrumentation> element in a *DIAG_MODULE.xml* descriptor for server-scoped instrumentation or the *META-INF/weblogic-diagnostics.xml* descriptor for application-scoped instrumentation.

The following fragment shows the configuration for a delegating monitor and a custom monitor in an application. (You could modify this fragment for server-scoped instrumentation by replacing the application-scoped monitors with server-scoped monitors.)

Configuring Instrumentation

```
<instrumentation>
  <enabled>true</enabled>
  <wldf-instrumentation-monitor>
    <name>Servlet_Before_Service</name>
    <enabled>true</enabled>
    <dye-mask>USER1</dye-mask>
    <dye-filtering-enabled>true</dye-filtering-enabled>
    <action>TraceAction</action>
  </wldf-instrumentation-monitor>
  <wldf-instrumentation-monitor>
    <name>MyCustomMonitor</name>
    <enabled>true</enabled>
    <action>TraceAction</action>
    <location-type>before</location-type>
    <pointcut>call( * com.foo.bar.* get*(...));</pointcut>
  </wldf-instrumentation-monitor>
</instrumentation>
```

Note that the `Servlet_Before_Service` monitor sets a dye mask and enables dye filtering. This will be useful only if instrumentation is enabled at the server level and the `DyeInjection` monitor is enabled and properly configured. See [Chapter 11, “Configuring the DyeInjection Monitor to Manage Diagnostic Contexts,”](#) for information about configuring the `DyeInjection` monitor.

[Table 10-3](#) describes the `<wldf-instrumentation-monitor>` elements.

Table 10-3 `<wldf-instrumentation-monitor>` XML Elements in the *DIAG_MODULE.xml* or *weblogic-diagnostics.xml* file

Element	Description
<code><wldf-instrumentation-monitor></code>	The element that begins a diagnostic monitor configuration.
<code><enabled></code>	If <code>true</code> , the monitor is enabled. If <code>false</code> , the monitor is disabled. You enable or disable each monitor separately. The default value is <code>true</code> .

Table 10-3 <wldf-instrumentation-monitor> XML Elements in the *DIAG_MODULE.xml* or *weblogic-diagnostics.xml* file (Continued)

<name>	The name of the monitor. For standard and delegating monitors, use the names of the predefined monitors in Appendix B, “WLDf Instrumentation Library.” For custom monitors, an arbitrary string that identifies the monitor. The name for a custom monitor must be unique; that is, it cannot duplicate the name of any monitor in the library.
<description>	An optional element describing the monitor.
<action>	An optional element, which applies to delegating and custom monitors. If you do not specify at least one action, the monitor will not generate any information. You can specify multiple <action> elements. An action must be compatible with the monitor type. For the list of predefined actions for use by delegating and custom monitors, see Appendix B, “WLDf Instrumentation Library.”
<dye-filtering-enabled>	An optional element. If <code>true</code> , dye filtering is enabled for the monitor. If <code>false</code> , dye-filtering is disabled. The default value is <code>false</code> . In order to use dye filtering, the <code>DyeInjection</code> monitor must be configured appropriately at the server level.
<dye-mask>	An optional element. If dye filtering is enabled, the dye mask, when compared with the values in the diagnostic context, determines whether actions are taken. See Chapter 11, “Configuring the DyeInjection Monitor to Manage Diagnostic Contexts,” for information about dyes and dye filtering.
<properties>	An optional element. Sets <code>name=value</code> pairs for dye flags. Currently applies only to the <code>DyeInjection</code> monitor.
<location-type>	An optional element, whose value is one of <code>before</code> , <code>after</code> , or <code>around</code> . The location type determines when an action is triggered at a pointcut: before the pointcut, after the pointcut, or both before and after the pointcut. Applies only to custom monitors; standard and delegating monitors have predefined location types. A custom monitor must define a location type and a pointcut.

Table 10-3 <wldf-instrumentation-monitor> XML Elements in the *DIAG_MODULE.xml* or *weblogic-diagnostics.xml* file (Continued)

<pointcut>	<p>An optional element. A pointcut element contains an expression that defines joinpoints where diagnostic code will be inserted.</p> <p>Applies only to custom monitors; standard and delegating monitors have predefined pointcuts. A custom monitor must define a location type and a pointcut.</p> <p>Pointcut syntax is documented in “Defining Pointcuts for Custom Monitors” on page 10-22</p>
------------	---

Table 10-3 <wldf-instrumentation-monitor> XML Elements in the *DIAG_MODULE.xml* or *weblogic-diagnostics.xml* file (Continued)

<include>	<p>An optional element specifying the list of classes where instrumented code can be inserted. Wildcards (*) are supported. You can specify multiple <include> elements. If specified, a class must satisfy an <include> pattern for it to be instrumented.</p> <p>Applies only to application-scoped instrumentation. Any specified <include> or <exclude> patterns are applied only to the monitor defined in the parent <wldf-instrumentation-monitor> element.</p> <p>Note: You can also specify <include> and <exclude> patterns for an entire instrumented application scope. See the entries for <include> and <exclude> in Table 10-2.</p> <p>As classes are loaded, they must pass an include/exclude pattern check before any instrumentation code is inserted. Even if a class passes the include/exclude pattern checks, whether or not it is instrumented depends on the diagnostic monitors included in the configuration descriptor. An application-scoped delegating monitor from the library has its own predefined classes and pointcuts. A custom monitor specifies its own pointcut expression. Therefore a class can pass the include/exclude checks and still not be instrumented.</p> <p>Note: Instrumentation is inserted in applications at class load time. A large application that is loaded often may benefit from a judicious use of <include> and/or <exclude> elements. You can probably ignore these elements for small applications or for medium-to-large applications that are loaded infrequently.</p>
<exclude>	<p>An optional element specifying the list of classes where instrumented code cannot be inserted. Wildcards (*) are supported. You can specify multiple <exclude> elements. If specified, classes satisfying an <exclude> pattern are not instrumented.</p> <p>Applies only to diagnostic monitors in application-scoped instrumentation. See the <include> description, above.</p>

Additional information on <dye-filtering-enabled> and <dye-mask> follows:

- When a `DyeInjection` monitor is enabled and configured for a server or a cluster, you can use dye filtering in downstream delegating and custom monitors to inspect the dyes injected into a request’s diagnostic context by that `DyeInjection` monitor.
- The configuration of the `DyeInjection` monitor determines which bits are set in the 64-bit dye vector associated with a diagnostic context. When the <dye-filtering-enabled> attribute is enabled for a monitor, its diagnostic activity is suppressed if the dye vector in a request’s diagnostic context does not match the monitor’s configured dye mask. If the dye vector matches the dye mask (a bitwise AND), the application can execute its diagnostic actions:

```
(dye_vector & dye_mask == dye_mask)
```

Thus, the dye filtering mechanism allows monitors to take diagnostic actions only for specific requests, without slowing down other requests. See [Chapter 11, “Configuring the DyeInjection Monitor to Manage Diagnostic Contexts,”](#) for detailed information on diagnostic contexts and dye vectors.

Mapping <wldf-instrumentation-monitor> XML Elements to Monitor Types

[Table 10-4](#) summarizes which <wldf-instrumentation-monitor> elements apply to which monitors.

Table 10-4 Mapping Instrumentation XML Elements to Monitor Types

Element	Standard	Delegating	Custom
<wldf-instrumentation-monitor>	X	X	X
<name>	X	X	X
<description>	X	X	X
<enabled>	X	X	X
<action>		X	X
<dye-filtering-enabled>		X	X
<dye-mask>		X	X

Table 10-4 Mapping Instrumentation XML Elements to Monitor Types (Continued)

Element	Standard	Delegating	Custom
<properties>	X ¹		
<location-type>			X
<pointcut>			X

1. Currently used only by the `DyeInjection` monitor to set `name=value` pairs for dye flags.

Configuring Server-Scoped Instrumentation

To enable instrumentation at the server level, and to configure server-scoped monitors, perform the following steps:

1. Decide how many WLDF system resources you want to create.

You can have multiple `DIAG_MODULE.xml` diagnostic descriptor files in a domain, but for each server (or cluster) you can deploy only one diagnostic descriptor file at a time. One reason for creating more than one file is to give yourself flexibility. You could have, for example, five diagnostic descriptor files in the `DOMAIN_NAME/config/diagnostics` directory. Each file contains a different instrumentation (and perhaps Harvester and Watch and Notification) configuration. You then deploy a file to a server based on which monitors you want active for specific situations.

2. Decide which server-scoped monitors you want to include in a configuration:
 - If you plan to use dye filtering on a server, or on any applications deployed on that server, configure the `DyeInjection` monitor.
 - If you plan to use one or more of the server-scoped delegating monitors, decide which monitors to use and which actions to associate with each monitor.
3. Create and configure the configuration file(s).
 - If you use the Administration Console to create the `DIAG_MODULE.xml` file (recommended), for delegating monitors, the console displays only actions that are compatible with the monitor. If you create a configuration file with an editor or with the WebLogic Scripting Tool (WLST), you must correctly match actions to monitors.
 - See the “[Domain Configuration Files](#)” in *Understanding Domain Configuration* for information about configuring `config.xml`.

4. Validate and deploy the descriptor file. For server-scoped instrumentation, you can add and remove monitors and enable or disable monitors while the server is running.

Listing 10-1 contains a sample server-scoped instrumentation configuration file which enables instrumentation, and configures the `DyeInjection` standard monitor and the `Connector_Before_Work` delegating monitor. A single `<instrumentation>` element contains all instrumentation configuration for the module. Each diagnostic monitor is defined in a separate `<wldf-instrumentation-monitor>` element.

Listing 10-1 Sample Server-Scoped Instrumentation (in `DIAG_MODULE.xml`)

```
<wldf-resource xmlns="http://www.bea.com/ns/weblogic/weblogic-diagnostics"
  xmlns:xsi="http://www.w3.org/2001/XMLSchema-instance"
  xsi:schemaLocation="http://www.bea.com/ns/weblogic/weblogic-diagnostics
/1.1/weblogic-diagnostics.xsd">
  <instrumentation>
    <enabled>true</enabled>
    <wldf-instrumentation-monitor>
      <name>DyeInjection</name>
      <description>Inject USER1 and ADDR1 dyes</description>
      <enabled>true</enabled>
      <properties>USER1=weblogic
        ADDR1=127.0.0.1</properties>
    </wldf-instrumentation-monitor>
    <wldf-instrumentation-monitor>
      <name>Connector_Before_Work</name>
      <enabled>true</enabled>
      <action>TraceAction</action>
      <dye-filtering-enabled>true</dye-filtering-enabled>
      <dye-mask>USER1</dye-mask>
    </wldf-instrumentation-monitor>
  </instrumentation>
</wldf-resource>
```

Configuring Application-Scoped Instrumentation

At the application level, WLDF instrumentation is configured as a deployable module, which is then deployed as part of the application.

The following sections provide information you need to configure application-scoped instrumentation:

- [“Comparing System-Scoped to Application-Scoped Instrumentation”](#) on page 10-17
- [“Overview of the Steps Required to Instrument an Application”](#) on page 10-18
- [“Creating a Descriptor File for a Delegating Monitor”](#) on page 10-20
- [“Creating a Descriptor File for a Custom Monitor”](#) on page 10-21
- [“Defining Pointcuts for Custom Monitors”](#) on page 10-22

Comparing System-Scoped to Application-Scoped Instrumentation

Instrumenting an application is similar to instrumenting at the system level, but with the following differences:

- Applications can use standard, delegating, and custom monitors.
 - The only server-scoped standard monitor is `DyeInjection`. The only application-scoped standard monitor is `HttpSessionDebug`. For more information, see the entry for `HttpSessionDebug` in [“Diagnostic Monitor Library”](#) on page B-1.
 - Delegating monitors are either server-scoped or application-scoped. Applications must use the application-scoped delegating monitors.
 - All custom monitors are application-scoped.
- The server’s instrumentation settings affect the application. In order to enable instrumentation for an application, instrumentation must be enabled for the server on which the application is deployed. If server instrumentation is enabled at the time of deployment, instrumentation will be available for the application. If instrumentation is not enabled on the server at the time of deployment, enabling instrumentation in an application will have no effect.
- Application instrumentation is configured with a `weblogic-diagnostics.xml` descriptor file. You create a `META-INF/weblogic-diagnostics.xml` file, configure the

instrumentation, and put the file in the application’s archive. When the archive is deployed, the instrumentation is automatically inserted when the application is loaded.

- You can use a *deployment plan* to dynamically update configuration elements without redeploying the application. See [“Using Deployment Plans for Dynamically Controlling Instrumentation Configuration.”](#)

The XML descriptors for application-scoped instrumentation are defined in the same way as for server-scoped instrumentation. You can configure instrumentation for an application solely by using the delegating monitors and diagnostic actions available in the WLDF Instrumentation Library. You can also create your own custom monitors; however, the diagnostic actions that you attach to these monitors must be taken from the WLDF Instrumentation Library.

[Table 10-5](#) compares the function and scope of system and application diagnostic modules.

Table 10-5 Comparing System and Application Modules

Module Type	Add or Remove Objects Dynamically	Add or Remove Objects with Console	Modify with JMX Remotely	Modify with JSR-88 (non-remote)	Modify with Console	Enable/Disable Dye Filtering and Dye Mask Dynamically
System Module	Yes	Yes	Yes	No	Yes (via JMX)	Yes
Application Module	Yes, when hot-swap is enabled No, when hot-swap is not enabled: module must be redeployed	Yes	No	Yes	Yes (via plan)	Yes

Overview of the Steps Required to Instrument an Application

Note: In WLS 10.3, you are not required to create a `weblogic-diagnostics.xml` file in the application’s META-INF directory, as was the case in previous WLS releases. You can, however, still use this method to initially configure diagnostic monitors for your application.

To implement a diagnostic monitor for an application, perform the following steps:

1. Make sure that instrumentation is enabled on the server. See [“Configuring Server-Scoped Instrumentation” on page 10-15](#).
2. Create a well formed `META-INF/weblogic-diagnostics.xml` descriptor file for the application. If you want to add any monitors that will be automatically enabled each time the application is deployed:
 - Enable the `<instrumentation>` element: `<enabled>true</enabled>`.
 - Add and enable at least one diagnostic monitor, with appropriate actions attached to it. (A monitor will generate diagnostic events only if the monitor is enabled and actions that generate events are attached to it.).

See [“Creating a Descriptor File for a Delegating Monitor” on page 10-20](#) and [“Creating a Descriptor File for a Custom Monitor” on page 10-21](#) for samples of well-formed descriptor files.

See [“Defining Pointcuts for Custom Monitors” on page 10-22](#) for information on creating a pointcut expression.

3. Put the descriptor file in the application archive.
4. Deploy the application. See [Chapter 13, “Deploying WLDF Application Modules.”](#)

Keep the following points in mind:

- The diagnostic monitors defined in `weblogic-diagnostics.xml` will be listed on the **Deployments: <server_name>: Configuration: Instrumentation** page of the Administration Console.
- If the `META-INF/weblogic-diagnostics.xml` descriptor in the application archive defines a monitor, it can't be removed using the Administration Console. It can, however, be disabled or enabled using the Administration Console.
- You can add additional monitors from the Administration Console. Any monitors you add from the Administration Console will *not* be persisted to `weblogic-diagnostics.xml`; they will be saved in the application's deployment plan. Any monitors that were added in this way can be deleted using the Administration Console.

Creating a Descriptor File for a Delegating Monitor

The following example shows a well-formed `META-INF/weblogic-diagnostics.xml` descriptor file for an application-scoped delegating monitor. At a minimum, this file must contain the lines shown in bold. In this example, there is only one monitor defined (`Servlet_Before_Service`). You can, however, define multiple monitors in the descriptor file.

```
<wldf-resource xmlns="http://www.bea.com/ns/weblogic/weblogic-diagnostics"
  xmlns:xsi="http://www.w3.org/2001/XMLSchema-instance"
  xsi:schemaLocation="http://www.bea.com/ns/weblogic/weblogic-diagnostics
/1.1/weblogic-diagnostics.xsd">

  <instrumentation>
    <enabled>true</enabled>
    <wldf-instrumentation-monitor>
      <name>Servlet_Before_Service</name>
      <enabled>true</enabled>
      <dye-mask>USER1</dye-mask>
      <dye-filtering-enabled>true</dye-filtering-enabled>
      <action>TraceAction</action>
    </wldf-instrumentation-monitor>
  </instrumentation>
</wldf-resource>
```

The `Servlet_Before_Service` monitor is an application-scoped monitor selected from the WLDF monitor library. It is hard coded with a pointcut that sets joinpoints at method entry for several servlet or JSP methods. Because the application enables dye filtering and sets the `USER1` flag in its dye mask, the `TraceAction` action will be invoked only when the dye vector in the diagnostic context passed to the application also has its `USER1` flag set.

The dye vector is set at the system level via the `DyeInjection` monitor as per the `DyeInjection` monitor configuration when the request enters the server. For example, if the `DyeInjection` monitor is configured with property `USER1=weblogic` and the request was originated by user `weblogic`, the `USER1` dye flag in the dye vector will be set.

Therefore, the `Servlet_Before_Service` monitor in this application is essentially quiescent until it inspects a dye vector and finds the `USER1` flag set. This filtering reduces the amount of diagnostic data generated, and ensures that the generated data is of interest to the administrator.

Creating a Descriptor File for a Custom Monitor

The following is an example of a well-formed `META-INF/weblogic-diagnostics.xml` file for a custom monitor. At a minimum, the file must contain the lines shown in bold.

Listing 10-2 Sample Custom Monitor Configuration (in *DIAG_MODULE.xml*)

```

<wldf-resource xmlns="http://www.bea.com/ns/weblogic/weblogic-diagnostics"
  xmlns:xsi="http://www.w3.org/2001/XMLSchema-instance"
  xsi:schemaLocation="http://www.bea.com/ns/weblogic/weblogic-diagnostics
/1.1/weblogic-diagnostics.xsd">

  <instrumentation>
    <enabled>true</enabled>
    <wldf-instrumentation-monitor>
      <name>MyCustomMonitor</name>
      <enabled>true</enabled>
      <action>TraceAction</action>
      <location-type>before</location-type>
      <pointcut>call( * com.foo.bar.* get* (...));</pointcut>
    </wldf-instrumentation-monitor>
  </instrumentation>
</wldf-resource>

```

The `<name>` for a custom monitor is an arbitrary string chosen by the developer. Because this monitor is custom, it has no predefined locations when actions should be invoked; the descriptor file must define the location type and pointcut expression. In this example, the `TraceAction` action will be invoked before (`<location-type>before</location-type>`) any methods defined by the pointcut expression is invoked. [Table 10-6](#) shows how the pointcut expression from [Listing 10-2](#) is parsed. (Note the use of wildcards.)

Table 10-6 Description of a Sample Pointcut Expression

Pointcut Expression	Description
<code>call(* com.foo.bar.* get* (...)</code>	<code>call()</code> : Trigger any defined actions when the methods whose joinpoints are defined by the remainder of this pointcut expression are invoked.
<code>call(* com.foo.bar.* get* (...)</code>	<code>*</code> : Return value. The wildcard indicates that the methods can have any type of return value.
<code>call(* com.foo.bar.* get* (...)</code>	<code>com.foo.bar.*</code> : Methods from class <code>com.foo.bar</code> and its subpackages are eligible.
<code>call(* com.foo.bar.* get* (...)</code>	<code>get*</code> : Any methods whose name starts with the string <code>get</code> is eligible.
<code>call(* com.foo.bar.* get* (...)</code>	<code>(...)</code> : The ellipsis indicates that the methods can have any number of arguments.

This pointcut expression matches all `get*()` methods in all classes in package `com.foo.bar` and its subpackages. The methods can return values of any type, including `void`, and can have any number of arguments of any type. Instrumentation code will be inserted before these methods are called, and, just before those methods are called, the `TraceAction` action will be invoked.

See [“Defining Pointcuts for Custom Monitors” on page 10-22](#) for a description of the grammar used to define pointcuts.

Defining Pointcuts for Custom Monitors

Custom monitors provide more flexibility than delegating monitors because you create pointcut expressions to control where diagnostics actions are invoked. As with delegating monitors, you must select actions from the action library.

A joinpoint is a specific, well-defined location in a program. A pointcut is an expression that specifies a set of joinpoints. This section describes how you define expressions for pointcuts using the following pointcut syntax.

You can specify two types of pointcuts for custom monitors:

- *call*: Take an action when a method is invoked.
- *execution*: Take an action when a method is executed.

The syntax for defining a pointcut expression is as follows:

```

pointcutExpr := orExpr ( 'OR' orExpr ) *
orExpr := andExpr ( 'AND' andExpr ) *
andExpr := 'NOT' ? termExpr
termExpr := exec_pointcut | call_pointcut | '(' pointcutExpr ')'
exec_pointcut := 'execution' '(' modifiers?
                returnSpec
                classSpecWithAnnotations
                methodSpec '(' parameterList ')'
                ')'
call_pointcut := 'call' '(' returnSpec
                classSpec
                methodSpec '(' parameterList ')'
                ')'
modifiers := modifier ( 'OR' modifier ) * modifier := 'public' | 'protected'
| 'private' | 'static'
returnSpec := '*' | typeSpec
classSpecWithAnnotations := '@' IDENTIFIER ( 'OR' IDENTIFIER ) * | classSpec
classSpec := '+' ? classOrMethodPattern | '*'
typeSpec := ( primitiveType | classSpec ) ( '[' ] )*
methodSpec := classOrMethodPattern
parameterList := param ( ',' param ) *
param := typeSpec | '...'
primitiveType := 'byte' | 'char' | 'boolean' | 'short' | 'int' | 'float' |
'long' | 'double' | 'void'
classOrMethodPattern := '*' ? IDENTIFIER '*'? | '*'

```

The following rules apply:

- Wildcards (*) can be used in class types and method names.
- An ellipsis (...) in the argument list signifies a variable number of arguments of any types beyond the argument.
- A + (plus sign) prefix to a class type identifies all subclasses, subinterfaces or concrete classes implementing the specified class/interface pattern.
- A pointcut expression specifies a pattern to identify matching joinpoints. An attempt to match a joinpoint against it will return a boolean, indicating a valid match (or not).
- Pointcut expressions can be combined with AND, OR and NOT boolean operators to build complex pointcut expression trees.

For example, the following pointcut matches method executions of all public `initialize` methods in all classes in package `com.foo.bar` and its subpackages. The `initialize` methods may return values of any type, including `void`, and may have any number of arguments of any types.

```
execution(public * com.foo.bar.* initialize(...))
```

The following pointcut matches the method calls (callsites) on all classes that directly or indirectly implement the `com.foo.bar.MyInterface` interface (or a subclass, if it happens to be a class). The method names must start with `get`, be public, and return an `int` value. The method must accept exactly one argument of type `java.lang.String`:

```
call(int +com.foo.bar.MyInterface get*(java.lang.String))
```

The following example shows how to use boolean operators to build a pointcut expression tree:

```
call(void com.foo.bar.* set*(java.lang.String)) OR  
call( * com.foo.bar.* get*())
```

The following example illustrates how the previous expression tree would be rendered as a `<pointcut>` element in a configuration file:

```
<pointcut>call(void com.foo.bar.* set*(java.lang.String)) OR  
call( * com.foo.bar.* get*())</pointcut>
```

Annotation-based Pointcuts

You can use JDK-style annotations in class and method specifiers of execution points. A class or method specifier starting with '@' is interpreted as an annotation name.

When used as a class specifier, the annotation matches all classes that are annotated with it. While performing the match, only annotation names are considered. Annotation attributes are ignored.

For example, the following pointcut:

```
execution(public void @Service @Invocation (...))
```

matches methods that:

- are public method
- return void
- are contained in a class that is annotated with @Service
- have a method annotated with @Invocation
- contain any number of arguments.

Note: Annotation-based specifiers can be used only with execution pointcuts. They cannot be used with call pointcuts.

Annotation-based class and method specifiers can use the following wild cards:

- * matches everything.
- * at the beginning matches class/interface or method names that end with the given string. For example, *Bean matches with weblogic.management.configuration.ServerMBean.
- * at the end matches class/interface or method names that end with the given string. For example, weblogic.* matches all classes and interfaces that are in weblogic and its sub-packages.
- You can specify a pointcut based on names of inner classes. For example:

```
public class Foo {
    class Bar {
        public int getValue() {...}
    }
}
```

Configuring Instrumentation

You can define a pointcut that covers the `getValue` method of the inner class `Bar` using the following specification:

```
execution (public int Foo$Bar getValue(...));
```

You can also use wildcards. For example:

```
execution ( * Foo$Bar get*(...));
```

matches only the getter methods in the inner class `Bar` of class `Foo`.

You can also use leading and trailing wild cards:

```
execution ( * Foo$Ba* get*(...));
```

```
execution ( * *oo$Bar get*(...));
```

```
execution ( * *oo$Ba* get*(...));
```

also matches the getter methods in class `Foo$Bar`.

Configuring the DyeInjection Monitor to Manage Diagnostic Contexts

The WLDF Instrumentation component provides a way to uniquely identify requests (such as HTTP or RMI requests) and track them as they flow through the system. You can configure WLDF to check for certain characteristics (such as the originating user or client address) of every request that enters the system and attach a *diagnostic context* to the request. This allows you to take measurements (such as elapsed time) of specific requests to get an idea of how all requests are being processed as they flow through the system.

The diagnostic context consists of two pieces: a unique Context ID and a 64-bit dye vector that represents the characteristics of the request. The Context ID associated with a given request is recorded in the Event Archive and can be used to:

- *Throttle* instrumentation event generation, that is determine how often events are generated when specified conditions are met
- Associate log records with a request
- Filter searches of log or event records using the WLDF Accessor component (see [Chapter 12, “Accessing Diagnostic Data With the Data Accessor”](#)).

The process of configuring and using a diagnostic context is described in the following sections:

- [“Contents, Life Cycle, and Configuration of a Diagnostic Context”](#) on page 11-2
- [“Overview of the Process”](#) on page 11-4
- [“Configuring the Dye Vector via the DyeInjection Monitor”](#) on page 11-5
- [“Configuring Delegating Monitors to Use Dye Filtering”](#) on page 11-9

- “How Dye Masks Filter Requests to Pass to Monitors” on page 11-12
- “Using Throttling to Control the Volume of Instrumentation Events” on page 11-14

Contents, Life Cycle, and Configuration of a Diagnostic Context

A diagnostic context contains a unique *Context ID* and a 64-bit *dye vector*. The dye vector contains flags which are set to identify the characteristics of the diagnostic context associated with a request. Currently, 32 bits of the dye vector are used, one for each available dye flag (see [Table 11-1](#)).

Context Life Cycle and the Context ID

The diagnostic context for a request is created and initialized when the request enters the system (for example, when a client makes an HTTP request). The diagnostic context remains attached to the request, even as the request crosses thread boundaries and Java Virtual Machine (JVM) boundaries. The diagnostic context lives for the duration of the life cycle of the request.

Every diagnostic context is identified by a Context ID that is unique in the domain. Because the Context ID travels with the request, it is possible to determine the events and log entries associated with a given request as it flows through the system.

Dyes, Dye Flags, and Dye Vectors

Contextual information travels with a request as a 64-bit dye vector, where each bit is a flag to identify the presence of a *dye*. Each dye represents one attribute of a request; for example, an originating user, an originating client IP address, access protocol, and so on.

When a dye flag for a given attribute is set, it indicates that the attribute is present. When the flag is not set, it indicates the attribute is not present.

For example, consider a configuration where:

- the flag `ADDR1` is configured to indicate a request that originated from IP address `127.0.0.1`.
- the flag `ADDR2` is configured to indicate a request that originated from IP address `127.0.0.2`.
- the flag `USER1` is configured to indicate a request that originated from user `admin@avitek.com`.

If a request from IP address `127.0.0.1` enters the system from a user other than `admin@avitek.com`, the `ADDR1` flag in the dye vector for the request is set. The `ADDR2` and `USER1` dye flags remain unset.

If a request from `admin@avitek.com` enters the system from an IP address other than `127.0.0.1` or `127.0.0.2`, the `USER1` flag in the dye vector for the request is set. The `ADDR1` and `ADDR2` dye flags remain unset.

If a request from `admin@avitek.com` from IP address `127.0.0.2` enters the system, both the `USER1` and `ADDR2` flags in the dye vector for this request are set. The `ADDR1` flag remains unset.

Diagnostic and monitoring features that take advantage of the diagnostic context can examine the dye vector to determine if one or more attributes are present (that is, the associated flag is set). In the example above, you could configure a diagnostic monitor to trace every request that is dyed with `ADDR1`, that is, that originated from IP address `127.0.0.1`. You could also configure a diagnostic monitor that traces every request that is dyed with both `ADDR1` and `USER1`, that is, the request originated from user `admin@avitek.com` at IP address `127.0.0.1` (requests from other users at `127.0.0.1` would *not* be traced).

The dye vector also contains a `THROTTLE` dye, which is used to set how often incoming requests are dyed. For more information about this special dye, see [“THROTTLE Dye Flag” on page 11-9](#).

For a list of the available dyes and the attributes they represent, see [“Dyes Supported by the DyeInjection Monitor” on page 11-7](#). The process of configuring dye vectors and using them is discussed throughout the rest of this chapter.

Where Diagnostic Context Is Configured

Diagnostic context is configured as part of a diagnostic module. You use the `DyeInjection` monitor at the server level to configure the diagnostic context. The `DyeInjection` monitor is a *standard* diagnostic monitor, so you cannot modify its behavior. The joinpoints where the `DyeInjection` monitor is woven into the code are those locations where a request can enter the system.

The *diagnostic action* is to check every request against the `DyeInjection` monitor’s configuration, then create and attach a diagnostic context to the request, setting the dye flags as appropriate. If the dye flags that are set for a request match the dye flags that are configured for a downstream diagnostic monitor, an event with the request’s associated Context ID is added to the Event Archive. So, for example, if a request has only the `USER1` and `ADDR1` dye flags set, and there is a diagnostic monitor configured to trace requests with both the `USER1` and `ADDR1` flags set (but no other flags set), an event is added to the Event Archive.

For information about diagnostic monitor types, pointcuts (which define the joinpoints), and diagnostic actions, see [Chapter 10, “Configuring Instrumentation.”](#)

Overview of the Process

This overview describes the configuration and use of context in a server-scoped diagnostic module.

1. Configure a dye vector via the DyeInjection Module. See [“Configuring the Dye Vector via the DyeInjection Monitor” on page 11-5.](#)
2. When any request enters the system, WLDF creates and instantiates a diagnostic context for the request. The context includes a unique Context ID and a dye vector.
3. The `DyeInjection` monitor, if enabled at the server level within a WLDF diagnostic module, examines the request to see if any of the configured dye values in the dye vector match attributes of the request. For example, it checks to see if the request originated from the user associated with `USER1` or `USER2`, and it checks to see if the request came from the IP address associated with `ADDR1` or `ADDR2`.
4. For each dye value that matches a request attribute, the `DyeInjection` monitor sets the associated dye bits within the diagnostic context. For example, if the `DyeInjection` monitor is configured with `USER1=weblogic`, `USER2=admin@avitek.com`, `ADDR1=127.0.0.1`, `ADDR2=127.0.0.2`, and the request originated from user `weblogic` at IP address `127.0.0.2`, it will set the `USER1` and `ADDR2` dye bits within the dye vector.
5. As the request flows through the system, the diagnostic context (which includes the dye vector) flows with it as well. This 64-bit dye vector contains only flags, not values. So, in this example, the dye vector contains only two flags that are explicitly set (`USER1` and `ADDR2`). It does not contain the actual user name and IP address associated with `USER1` and `ADDR2`.
Note: All dye vectors also contain one of the implicit `PROTOCOL` dyes, as explained in [“Configuring the Dye Vector via the DyeInjection Monitor.”](#)
6. The administrator configures a diagnostic monitor (either application-scoped or server-scoped) to be active within downstream code, setting the monitor’s dye mask as `USER1` and `ADDR2`. See [“Configuring Delegating Monitors to Use Dye Filtering” on page 11-9](#) for more information.
7. The diagnostic monitor will perform its associated action(s) if the dye flags that are set in the diagnostic context’s dye vector match the dye mask of the diagnostic monitor. See [“How Dye Masks Filter Requests to Pass to Monitors” on page 11-12](#) for more details. In this example,

the monitor will perform its action(s) if the `USER1` and `ADDR2` flags are set in the dye vector. In addition, an event associated with the request will be written to the Event Archive.

Configuring the Dye Vector via the DyeInjection Monitor

To create diagnostic contexts for all requests coming into the system, you must:

1. Create and enable a diagnostic module for the server (or servers) you want to monitor.
2. Enable Instrumentation for the diagnostic module.
3. Configure and enable the `DyeInjection` monitor for the module. (Only one `DyeInjection` monitor can be used with a diagnostic module at any one time.)

You configure the `DyeInjection` monitor by assigning values to dyes. The available dye flags are described in [Table 11-1](#).

For example, you could set the flags as follows: `USER1=weblogic`, `USER2=admin@avitek.com`, `ADDR1=127.0.0.1`, `ADDR2=127.0.0.2`, and so forth. Basically, you want to set the values of one or more flags to the user(s), IP address(es) whose requests you want to monitor.

For example, to monitor all requests initiated by a user named `admin@avitek` from a client at IP address `127.0.0.1`, assign the value `admin@avitek` to `USER1` and assign the value `127.0.0.1` to `ADDR1`.

In the Administration Console, you assign values to dyes by typing them into the **Properties** field of the **Settings for DyeInjection** page. For instructions, see [“Configure diagnostic monitors in a diagnostic system module”](#) in the *Administration Console Online Help*.

Figure 11-1 Setting Dye Values in the Administration Console

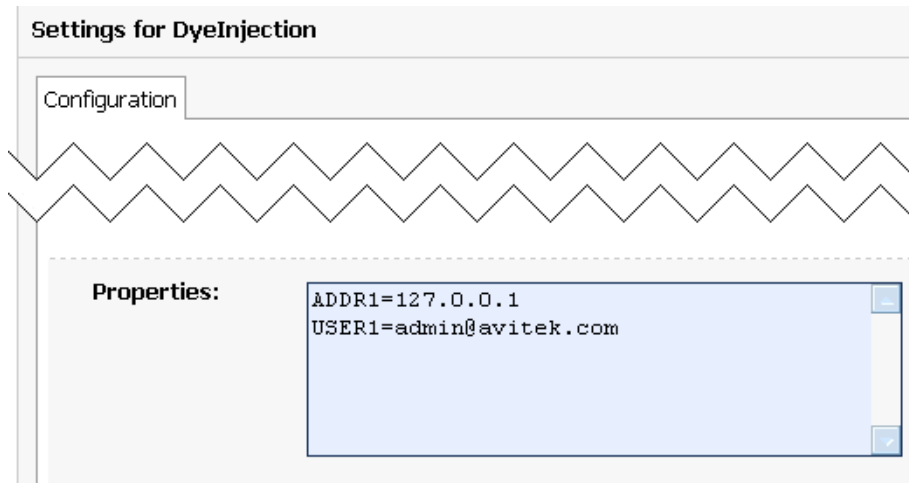

These settings appear in the descriptor file for the diagnostic module, as shown in the following code listing.

Listing 11-1 Sample DyeInjection Monitor Configuration, in *DIAG_MODULE.xml*

```
<wldf-resource>
  <name>MyDiagnosticModule</name>
  <instrumentation>
    <enabled>true</enabled>
    <wldf-instrumentation-monitor>
      <name>DyeInjection</name>
      <enabled>true</enabled>
      <dye-mask xsi:nil="true"></dye-mask>
      <properties>ADDR1=127.0.0.1
        USER1=admin@avitek</properties>
    </wldf-instrumentation-monitor>
    <!-- Other elements to configure instrumentation -->
  </instrumentation>
  <!-- Other elements to configure this diagnostic monitor -->
</wldf-resource>
```

Dyes Supported by the DyeInjection Monitor

The dyes available in the dye vector are listed and explained in the following table.

Table 11-1 Request Protocols for Supported Diagnostic Context Dyes

Dye Flags	Description
ADDR1 ADDR2 ADDR3 ADDR4	Use the ADDR1, ADDR2, ADDR3 and ADDR4 dyes to specify the IP addresses of clients that originate requests. These dye flags are set in the diagnostic context for a request if the request originated from an IP address specified by the respective property (ADDR1, ADDR2, ADDR3, ADDR4) of the <code>DyeInjection</code> monitor. These dyes cannot be used to specify DNS names.
CONNECTOR1 CONNECTOR2 CONNECTOR3 CONNECTOR4	Use the CONNECTOR1, CONNECTOR2, CONNECTOR3 and CONNECTOR4 dyes to identify characteristics of connector drivers. These dye flags are set by the connector drivers to identify request properties specific to their situations. You do not configure these directly in the Administration Console or in the descriptor files. The connector drivers can assign values to these dyes (using the Connector API), so information about the connections can be carried in the diagnostic context.
COOKIE1 COOKIE2 COOKIE3 COOKIE4	COOKIE1, COOKIE2, COOKIE3 and COOKIE4 are set in the diagnostic context for an HTTP/S request, if the request contains the cookie named <code>weblogic.diagnostics.dye</code> and its value is equal to the value of the respective property (COOKIE1, COOKIE2, COOKIE3, COOKIE4) of the <code>DyeInjection</code> monitor.
DYE_0 DYE_1 DYE_2 DYE_3 DYE_4 DYE_5 DYE_6 DYE_7	DYE_0 to DYE_7 are available only for use by application developers. See “Using <code>weblogic.diagnostics.context</code>” on page 11-17 .

Table 11-1 Request Protocols for Supported Diagnostic Context Dyes

Dye Flags	Description
PROTOCOL_HTTP PROTOCOL_IIOP PROTOCOL_JRMP PROTOCOL_RMI PROTOCOL_SOAP PROTOCOL_SSL PROTOCOL_T3	The <code>DyeInjection</code> monitor implicitly identifies the protocol used for a request and sets the appropriate dye(s) in the dye vector, according to the protocol(s) used. PROTOCOL_HTTP is set in the diagnostic context of a request if the request uses HTTP or HTTPS protocol. PROTOCOL_IIOP is set in the diagnostic context of a request if it uses Internet Inter-ORB Protocol (IIOP). PROTOCOL_JRMP is set in the diagnostic context of a request if it uses the Java Remote Method Protocol (JRMP). PROTOCOL_RMI is set in the diagnostic context of a request if it uses the Java Remote Method Invocation (RMI) protocol. PROTOCOL_SSL is set in the diagnostic context of a request if it uses the Secure Sockets Layer (SSL) protocol. PROTOCOL_T3 is set in the diagnostic context of a request if the request uses T3 or T3s protocol
THROTTLE	The THROTTLE dye is set in the diagnostic context of a request if it satisfies requirements specified by THROTTLE_INTERVAL and/or THROTTLE_RATE properties of the <code>DyeInjection</code> monitor.
USER1 USER2 USER3 USER4	Use the USER1, USER2, USER3 and USER4 dyes to specify the user names of clients that originate requests. These dye flags are set in the diagnostic context for a request if the request was originated by a user specified by the respective property (USER1, USER2, USER3, USER4) of the <code>DyeInjection</code> monitor.

PROTOCOL Dye Flags

You must explicitly set the values for the dye flags `USERn`, `ADDRn`, `COOKIEn`, and `CONNECTORn` in the `DyeInjection` monitor. However, the flags `PROTOCOL_HTTP`, `PROTOCOL_IIOP`, `ROTOCOL_JRMP`, `PROTOCOL_RMI`, `PROTOCOL_SOAP`, `PROTOCOL_SSL`, and `PROTOCOL_T3` are set implicitly by `WLDF`. When the `DyeInjection` monitor is enabled, every request is injected with the appropriate protocol dye. For example, every request that arrives via HTTP is injected with the `PROTOCOL_HTTP` dye.

THROTTLE Dye Flag

The `THROTTLE` dye flag can be used to control the volume of incoming requests that are dyed. `THROTTLE` is configured differently from the other flags, and `WLDF` uses it differently. See [“Using Throttling to Control the Volume of Instrumentation Events” on page 11-14](#) for more information.

When Diagnostic Contexts Are Created

When the `DyeInjection` monitor is enabled in a diagnostic module, a diagnostic context is created for every incoming request. The `DyeInjection` monitor is enabled by default when you enable instrumentation in a diagnostic module. This ensures that a diagnostic Context ID is available so that events can be correlated. Even if no properties are explicitly set in the `DyeInjection` monitor, the diagnostic context for every request will contain a unique Context ID and a dye vector with one of the implicit `PROTOCOL` dyes.

If the `DyeInjection` monitor is disabled, no diagnostic contexts will be created for any incoming requests.

Configuring Delegating Monitors to Use Dye Filtering

Note: For information on how to implement a diagnostic monitor for an application (such as a web application), see [“Overview of the Steps Required to Instrument an Application” on page 10-18](#).

You can use the `DyeInjection` monitor as a mechanism to restrict when a delegating or custom diagnostic monitor in the diagnostic module is triggered. This process is called *dye filtering*.

Each monitor can have a *dye mask*, which specifies a selection of the dyes from the `DyeInjection` monitor. When dye filtering is enabled for a diagnostic monitor, the monitor’s diagnostic action is triggered and a diagnostic event is generated only for those requests that meet the criteria set by the mask.

[Figure 11-2](#) shows an example of diagnostic events that were generated when a configured diagnostic action was triggered. Notice that the Context ID is the same for all of the events, indicating that they are related to the same request. You can use this Context ID to query for log records that are associated with the request. Note that the user ID associated with a request may not always be the same as the `USER` value you configured in the `DyeInjection` monitor; as a request is processed through the system, the user associated with the request may change to allow the system to perform certain functions (for example, the User ID may change to `kernel`).

Figure 11-2 Example of Diagnostic Events Associated with a Request

Date ↕	Context ID	User ID	Type	Monitor	Class	Method
06/20/08 07:52:55 509	513bb54e27d6cc3a:30c3eff2:11aa5c7b97a-7ff2-00000000000000bb	turmel	TraceElapsedTimeAction-Before-1	Servlet_Around_Session	javax.servlet.http.HttpServletRequest	getSession
06/20/08 07:52:55 509	513bb54e27d6cc3a:30c3eff2:11aa5c7b97a-7ff2-00000000000000bb	turmel	TraceElapsedTimeAction-After-1	Servlet_Around_Session	javax.servlet.http.HttpServletRequest	getSession
06/20/08 07:53:18 272	513bb54e27d6cc3a:30c3eff2:11aa5c7b97a-7ff2-00000000000000bb	turmel	TraceElapsedTimeAction-Before-2	Servlet_Around_Service	jsp_servlet__index	_jspService
06/20/08 07:53:18 272	513bb54e27d6cc3a:30c3eff2:11aa5c7b97a-7ff2-00000000000000bb	turmel	TraceAction	Servlet_Before_Service	jsp_servlet__index	_jspService
06/20/08 07:53:18 272	513bb54e27d6cc3a:30c3eff2:11aa5c7b97a-7ff2-00000000000000bb	turmel	TraceElapsedTimeAction-Before-3	Servlet_Around_Session	javax.servlet.http.HttpServletRequest	getSession
06/20/08 07:53:18 272	513bb54e27d6cc3a:30c3eff2:11aa5c7b97a-7ff2-00000000000000bb	turmel	TraceElapsedTimeAction-After-3	Servlet_Around_Session	javax.servlet.http.HttpServletRequest	getSession
06/20/08 07:53:18 442	513bb54e27d6cc3a:30c3eff2:11aa5c7b97a-7ff2-00000000000000bb	turmel	TraceElapsedTimeAction-Before-4	Servlet_Around_Session	javax.servlet.http.HttpSession	setAttribute
06/20/08 07:53:18 442	513bb54e27d6cc3a:30c3eff2:11aa5c7b97a-7ff2-00000000000000bb	turmel	TraceElapsedTimeAction-After-4	Servlet_Around_Session	javax.servlet.http.HttpSession	setAttribute
06/20/08 07:53:18 442	513bb54e27d6cc3a:30c3eff2:11aa5c7b97a-7ff2-00000000000000bb	turmel	TraceElapsedTimeAction-After-2	Servlet_Around_Service	jsp_servlet__index	_jspService
06/20/08 07:53:18 552	513bb54e27d6cc3a:30c3eff2:11aa5c7b97a-7ff2-00000000000000bb	turmel	TraceElapsedTimeAction-Before-5	Servlet_Around_Session	javax.servlet.http.HttpServletRequest	getSession

Example configuration

Consider a `Servlet_Around_Service` application-scoped diagnostic monitor that has a `TraceElapsedTimeAction` action attached to it. Without dye filtering, any request that is handled by `Servlet_Around_Service` will trigger a `TraceElapsedTimeAction`. You could, however, use dye filtering to trigger `TraceElapsedTimeAction` only for requests that originated from user `admin@avitek.com` at IP address `127.0.0.1`.

1. Configure the `DyeInjection` monitor so that `USER1=admin@avitek.com` and `ADDR1=127.0.0.1`, and enable the `DyeInjection` monitor. For instructions, see [“Configure diagnostic monitors in a diagnostic system module”](#) in the *Administration Console Online Help*.
2. Configure a `dye mask` and enable dye filtering for the `Servlet_Before_Service` diagnostic monitor. In the Administration Console:

- a. Add the `Servlet_Around_Service` monitor from the WLDf instrumentation library to your application as described in “[Configure instrumentation for applications](#)” in the *Administration Console Online Help*.
 - b. After adding the monitor, click **Save** on the **Settings for <application_name>** page.
 - c. Click the `Servlet_Around_Service` link to display the **Settings for Servlet_Around_Service** page.
 - d. Select the **Enabled** check box to enable the monitor.
 - e. Under **Actions**, move `TraceElapsedTimeAction` from the **Available** list to the **Chosen** list.
 - f. In the **Dye Mask** section, move `USER1` and `ADDR1` from the **Available** list to the **Chosen** list.
 - g. Select the **EnableDyeFiltering** check box.
 - h. Click **Save**.
3. Redeploy the application.

Configurations added via the Administration Console are *not* persisted to the `weblogic-diagnostics.xml` file in the application’s META-INF directory or to the `DIAG_MODULE.xml` file; they are saved in the application’s deployment plan.

You can also manually update your `DIAG_MODULE.xml` file to add diagnostic monitors, as shown in [Listing 11-2](#), but this is not recommended. It is better to change the configuration via the Administration Console on a running server. Any changes you make to `DIAG_MODULE.xml` will not take effect until you redeploy the application.

Listing 11-2 Sample Configuration for Using Dye Filtering in a Delegating Monitor, in `DIAG_MODULE.xml`

```
<wldf-resource>
  <name>MyDiagnosticModule</name>
  <instrumentation>
    <enabled>true</enabled>
    <wldf-instrumentation-monitor>
      <name>DyeInjection</name>
      <enabled>true</enabled>
      <properties>ADDR1=127.0.0.1 USER1=admin@avitek.com</properties>
```

Configuring the DyeInjection Monitor to Manage Diagnostic Contexts

```
</wldf-instrumentation-monitor>
<wldf-instrumentation-monitor>
  <name>Servlet_Around_Service</name>
  <dye-mask>ADDR1 USER1</dye-mask>
  <dye-filtering-enabled>true</dye-filtering-enabled>
  <action>TraceElapsedTimeAction</action>
</wldf-instrumentation-monitor>
<!-- Other elements to configure instrumentation -->
</instrumentation>
<!-- Other elements to configure this diagnostic monitor -->
<wldf-resource>
```

With this configuration, the `TraceElapsedTimeAction` action will be triggered for the `Servlet_Around_Service` diagnostic monitor only for those requests that originate from IP address `127.0.0.1` and user `admin@avitek.com`.

The flags that are enabled in the diagnostic monitor must exactly match the bits set in the request's dye vector for an action to be triggered and an event to be written to the Event Archive. For example, if the diagnostic monitor has both the `USER1` and `ADDR1` flags enabled, and only the `USER1` flag is set in the request's dye vector, no action will be triggered and no event will be generated.

Note: When configuring a diagnostic monitor, do not enable multiple flags of the same type. For example, don't enable both the `USER1` and `USER2` flags, as the dye vector for a given request will never have both the `USER1` and `USER2` flags set.

How Dye Masks Filter Requests to Pass to Monitors

A dye vector attached to a request can contain multiple dyes, and a dye mask attached to a delegating monitor can contain multiple dyes. For a delegating monitor's dye mask to allow a monitor to take action on a request, all of the following must be true:

- Dye filtering for the delegating or custom diagnostic monitor is enabled in the application's `weblogic-diagnostics.xml` descriptor, or is enabled via the Administration Console.
- The request's dye vector contains all of the dyes that are defined in the monitor's dye mask. (The dye vector can also contain dyes that are not in the dye mask.)

Dye Filtering Example

Figure 11-3 illustrates how dye filtering works, using a diagnostic module with three diagnostic monitors:

- The `DyeInjection` monitor is configured as follows:

```
ADDR1=127.0.0.1
USER1=weblogic
```

- The `Servlet_Around_Service` monitor is configured with a dye mask containing only `ADDR1`.
- The `EJB_Around_SessionEjbBusinessMethods` monitor is configured with a dye mask containing `USER1` only.

Figure 11-3 Dye Filtering Example

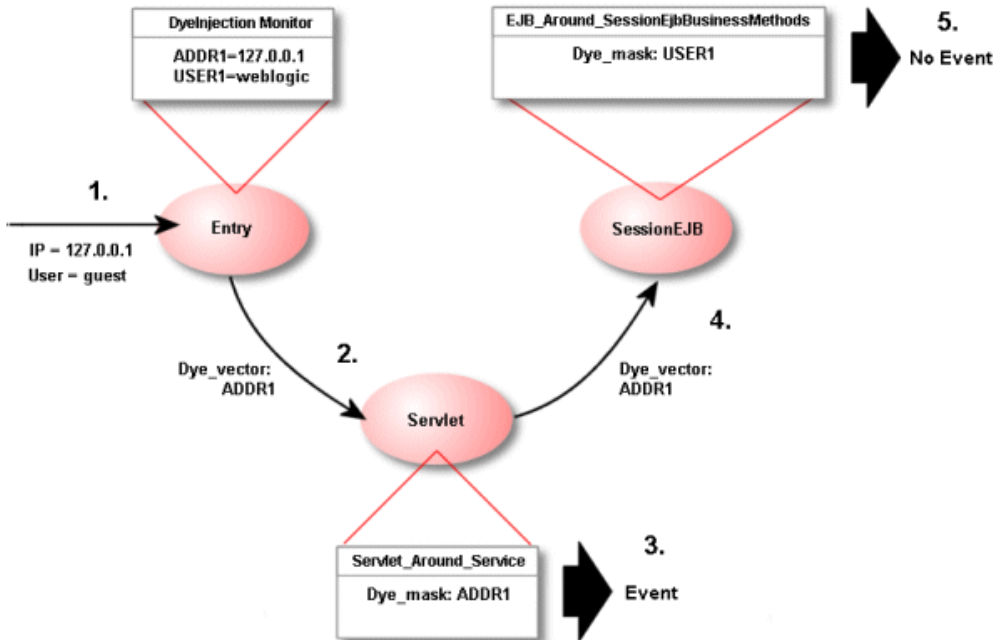

1. A request initiated by user `guest` from IP address `127.0.0.1` enters the system. The user `guest` does not match the value for `USER1` in the `DyeInjection` monitor, so the request is

not dyed with the dye vector `USER1`. The originating IP address (127.0.0.1) matches the value for `ADDR1` defined in the `DyeInjection` monitor, so the request *is* dyed with the dye vector `ADDR1`.

2. The request (dyed with `ADDR1`) enters the `Servlet` component, where the diagnostic monitor `Servlet_Around_Service` is woven into the code. (`Servlet_Around_Service` triggers diagnostic actions at the entry of and exit of certain servlet and JSP methods.) Dye monitoring is enabled for the monitor, and the dye mask is defined with the single value `ADDR1`.
3. When the request enters or exits a method instrumented with `Servlet_Around_Service`, the diagnostic monitor checks the request for dye vector `ADDR1`, which it finds. Therefore, the monitor triggers a diagnostic action, which generates a diagnostic event, for example, writing data to the Events Archive.
4. The request enters the `SessionEJB` component, where the diagnostic monitor `EJB_Around_SessionEjbBusinessMethods` is woven into the code. (`EJB_Around_SessionEjbBusinessMethods` triggers diagnostic actions at the entry and exit of all `SessionBean` methods). Dye monitoring is enabled for the monitor, and the dye mask is defined with the single value `USER1`.
5. When the request enters or exits a `SessionBean` method (instrumented with `EJB_Around_SessionEjbBusinessMethods`), the diagnostic monitor checks the request for dye vector `USER1`, which it does not find. Therefore, the monitor does not trigger a diagnostic action, and therefore does not generate a diagnostic event.

Using Throttling to Control the Volume of Instrumentation Events

Throttling is used to control the number of requests that are processed by the monitors in a diagnostic module. Throttling is configured using the `THROTTLE` dye, which is defined in the `DyeInjection` monitor.

Note: The `USERn` and `ADDRn` dyes allow inspection of requests from specific users or IP addresses. However, they do not provide a means to look at arbitrary user transactions. The `THROTTLE` dye provides that functionality by allowing sampling of requests.

Configuring the THROTTLE Dye

Unlike other dyes in the dye vector, the `THROTTLE` dye is configured through two properties.

- `THROTTLE_INTERVAL` sets an interval (in milliseconds) after which a new incoming request is dyed with the `THROTTLE` dye.

If the `THROTTLE_INTERVAL` is greater than 0, the `DyeInjection` monitor sets the `THROTTLE` dye flag in the dye vector of an incoming request if the last request dyed with `THROTTLE` arrived at least `THROTTLE_INTERVAL` before the new request. For example, if `THROTTLE_INTERVAL=3000`, the `DyeInjection` monitor waits at least 3000 milliseconds before it will dye an incoming request with `THROTTLE`.

- `THROTTLE_RATE` sets the rate (in terms of the number of incoming requests) by which new incoming requests are dyed with the `THROTTLE` dye.

If `THROTTLE_RATE` is greater than 0, the `DyeInjection` monitor sets the `THROTTLE` dye flag in the dye vector of an incoming request when the number of requests since the last request dyed with `THROTTLE` equals `THROTTLE_RATE`. For example, if `THROTTLE_RATE = 6`, every sixth request is dyed with `THROTTLE`.

You can use `THROTTLE_INTERVAL` and `THROTTLE_RATE` together. If either condition is satisfied, the request is dyed with the `THROTTLE` dye.

If you assign a value to either `THROTTLE_INTERVAL` or `THROTTLE_RATE` (or both, or neither), you are configuring the `THROTTLE` dye. A `THROTTLE` configuration setting in the Administration Console is shown in the following figure.

Figure 11-4 Configuring the THROTTLE Dye

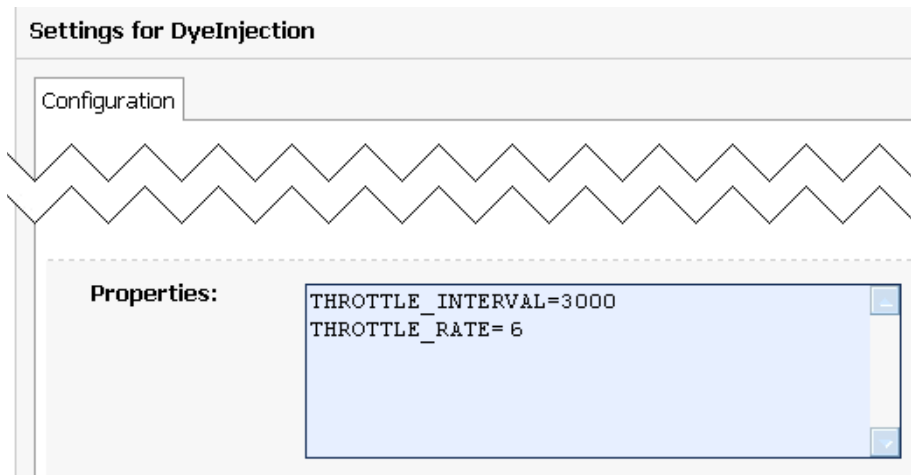

[Listing 11-3](#) shows the resulting configuration in the descriptor file for the diagnostics module.

Listing 11-3 Sample THROTTLE Configuration in the DyeInjection Monitor, in *DIAG_MODULE.xml*

```
<wldf-resource>
  <name>MyDiagnosticModule</name>
  <instrumentation>
    <wldf-instrumentation-monitor>
      <name>DyeInjection</name>
      <properties>
        THROTTLE_INTERVAL=3000
        THROTTLE_RATE=6
      </properties>
    </wldf-instrumentation-monitor>
  </instrumentation>
  <!-- Other elements to configure this diagnostic monitor -->
</wldf-resource>
```

[Listing 11-4](#) shows the configuration for a `JDBC_Before_Start_Internal` delegating monitor where the `THROTTLE` dye is set in the dye mask for the monitor.

Listing 11-4 Sample Configuration for Setting THROTTLE in a Dye Mask of a Delegating Monitor, in *DIAG_MODULE.xml*

```
<wldf-resource>
  <name>MyDiagnosticModule</name>
  <instrumentation>
    <wldf-instrumentation-monitor>
      <name>JDBC_Before_Start_Internal</name>
      <enabled>>true</enabled>
      <dye-mask>THROTTLE</dye-mask>
    </wldf-instrumentation-monitor>
  </instrumentation>
  <!-- Other elements to configure this diagnostic monitor -->
</wldf-resource>
```

How Throttling is Handled by Delegating and Custom Monitors

Dye masks and dye filtering provide a mechanism for restricting which requests are passed to delegating and custom monitors for handling, based on properties of the requests. The presence of a property in a request is indicated by the presence of a dye, as discussed in [“Configuring the Dye Vector via the DyeInjection Monitor” on page 11-5](#). One of those dyes can be the `THROTTLE` dye, so that you can filter on `THROTTLE`, just like any other dye.

The items in the following list explain how throttling is handled:

- If dye filtering for a delegating or custom monitor is enabled and that monitor has a dye mask, filtering is performed based on the dye mask. That mask may include the `THROTTLE` dye, but it does not have to. If `THROTTLE` is included in a dye mask, then `THROTTLE` must also be included in the request’s dye vector for the request to be passed to the monitor. However, if `THROTTLE` is not included in the dye mask, all qualifying requests are passed to the monitor, whether their dye vectors include `THROTTLE` or not.
- If dye filtering for a delegating or custom monitor is not enabled and neither `THROTTLE` property is set in the `DyeInjection` monitor, dye filtering will not take place and throttling will not take place.
- If dye filtering for a delegating or custom monitor is not enabled and `THROTTLE` is configured in the `DyeInjection` monitor, delegating monitors ignore dye masks but do check for the presence of the `THROTTLE` dye in all requests. Only those requests dyed with `THROTTLE` are passed to the delegating monitors for handling. Therefore, by setting a `THROTTLE_RATE` and/or `THROTTLE_INTERVAL` in the `DyeInjection` monitor, you reduce the number of requests handled by all delegating monitors. You do not have to configure dye masks for all your delegating monitors to take advantage of throttling.
- If dye filtering for a delegating or custom monitor is enabled and the only dye set in a dye mask is `THROTTLE`, only those requests that are dyed with `THROTTLE` are passed to the delegating monitor. This behavior is the same as when dye filtering is not enabled and `THROTTLE` is configured in the `DyeInjection` monitor.

Using `weblogic.diagnostics.context`

The `weblogic.diagnostics.context` package provides applications with limited access to a diagnostic context.

An application can use the `weblogic.diagnostics.context.DiagnosticContextHelper` APIs to perform the following functions:

- Inspect a diagnostics context's immutable context ID.
- Inspect the settings of the dye flags in a context's dye vector.
- Retrieve an array of valid dye flag names.
- Set, or unset, the `DYE_0` through `DYE_7` flags in a context's dye vector. (Note that there is no way to set these flag bits via XML. You can configure `DyeInjection` monitor `<properties>` to set the non-application-specific flag bits via XML, but `setDye()` is the only method for setting `DYE_0` through `DYE_7` in a dye vector.)
- Attach a payload (a `String`) to a diagnostic context, or read an existing payload.

An application cannot:

- Set any flags in a dye vector other than the eight flags reserved for applications.
- Prevent another application from setting the same application flags in a dye vector. A well-behaved application can test whether a dye flag is set before setting it.
- Prevent another application from replacing a payload. A well-behaved application can test for the presence of a payload before adding one.

A monitor, or another application, that is downstream from the point where an application has set one or more of the `DYE_0` through `DYE_7` flags can set a dye mask to check for those flags, and take an action when the flag(s) are present in a context's dye vector. If a payload is attached to the diagnostics context, any action taken by that monitor will result in the payload being archived, and thus available through the accessor component.

[Listing 11-5](#) is a short example which (implicitly) creates a diagnostic context, prints the context ID, checks the value of the `DYE_0` flag, and then sets the `DYE_0` flag.

Listing 11-5 Example: `DiagnosticContextExample.java`

```
package weblogic.diagnostics.examples;
import weblogic.diagnostics.context.DiagnosticContextHelper;

public class DiagnosticContextExample {
    public static void main(String args[]) throws Exception {
        System.out.println("\nContextId=" +
            DiagnosticContextHelper.getContextId());
        System.out.println("isDyedWith(DYE_0)=" +
            DiagnosticContextHelper.isDyedWith(DiagnosticContextHelper.DYE_0));
    }
}
```



```
DiagnosticContextHelper.setDye(DiagnosticContextHelper.DYE_0, true);
System.out.println("isDyedWith(DYE_0)=" +
    DiagnosticContextHelper.isDyedWith(DiagnosticContextHelper.DYE_0));
}
}
```

Configuring the DyelInjection Monitor to Manage Diagnostic Contexts

Accessing Diagnostic Data With the Data Accessor

You use the Data Accessor component of the WebLogic Diagnostic Framework (WLDF) to access diagnostic data from various sources, including log records, data events, and harvested metrics.

Using the Data Accessor, you can perform data lookups by type, component, and attribute. You can perform time-based filtering and, when accessing events, filtering by severity, source, and content. You can also access diagnostic data in tabular form.

The following sections describe the Data Accessor and describes how to use it online (when a server is running) and offline (when a server is not running):

- [“Data Stores Accessed by the Data Accessor” on page 12-1](#)
- [“Accessing Diagnostic Data Online” on page 12-2](#)
- [“Accessing Diagnostic Data Offline” on page 12-4](#)
- [“Resetting the System Clock Can Affect How Data Is Archived and Retrieved” on page 12-12](#)

Data Stores Accessed by the Data Accessor

The Data Accessor retrieves diagnostic information from other WLDF components. Captured information is segregated into logical data stores that are separated by the types of diagnostic data. For example, server logs, HTTP logs, and harvested metrics are captured in separate data stores.

WLDF maintains diagnostic data on a per-server basis. Therefore, the Data Accessor provides access to data stores for individual servers.

Data stores can be modeled as tabular data. Each record in the table represents one item, and the columns describe characteristics of the item. Different data stores may have different columns. However, most data stores have some of the same columns, such as the time when the data was collected.

The Data Accessor can retrieve the following information about data stores used by WLDF for a server:

- A list of supported data store types, including:
 - HTTP_LOG
 - HARVESTED_DATA_ARCHIVE
 - EVENTS_DATA_ARCHIVE
 - SERVER_LOG
 - DOMAIN_LOG
 - HTTP_ACCESS_LOG
 - WEBAPP_LOG
 - CONNECTOR_LOG
 - JMS_MESSAGE_LOG
 - CUSTOM_LOG
- A list of available data store instances
- The layout of each data store (information that describes the columns in the data store)

You can use the `WLDFAccessRuntimeMBean` to discover such data stores, determine the nature of the data they contain, and access their data selectively using a query.

For complete documentation about WebLogic logs, see [Configuring Log Files and Filtering Log Messages](#).

Accessing Diagnostic Data Online

You access diagnostic data from a running server by using the Administration Console, JMX APIs, or the WebLogic Scripting Tool (WLST).

Accessing Data Using the Administration Console

You do not use the Data Accessor explicitly in the Administration Console, but information collected by the Accessor is displayed, for example, in the Summary of Log Files page. See [“View and Configure Logs”](#) in the *Administration Console Online Help*.

Accessing Data Programmatically Using Runtime MBeans

The Data Accessor provides the following runtime MBeans for discovering data stores and retrieving data from them:

- Use the `WLDFAccessRuntimeMBean` to do the following:
 - Get the logical names of the available data stores on the server.
 - Look up a `WLDFDataAccessRuntimeMBean` to access the data from a specific data source, based on its logical name. The different data stores are uniquely identified by their logical names.

See [WLDFAccessRuntimeMBean](#) in the *WebLogic Server MBean Reference*.

- Use the `WLDFDataAccessRuntimeMBean` to retrieve data stores based on a search condition, or query. You can optionally specify a time interval with the query, to retrieve data records within a specified time duration. This MBean provides meta-data about the columns of the data set and the earliest and latest timestamp of the records in the data store.

Data Accessor runtime Mbeans are currently created and registered lazily. So, when a remote client attempts to access them, they may not be present and an `InstanceNotFoundException` may be thrown.

The client can retrieve the `WLDFDataAccessRuntimes` attribute of the `WLDFAccessRuntime` to cause all known data access runtimes to be created, for example:

```
ObjectName objName =
    new ObjectName("com.bea:ServerRuntime=" + serverName +
        ",Name=Accessor," +
        "Type=WLDFAccessRuntime," +
        "WLDFRuntime=WLDFRuntime");
rmbs.getAttribute(objName, "WLDFDataAccessRuntimes");
```

See [WLDFDataAccessRuntimeMBean](#) in the *WebLogic Server MBean Reference*.

Using WLST to Access Diagnostic Data Online

Use the WLST `exportDiagnosticDataFromServer` command to access diagnostic data from a running server. For the syntax and examples of this command, see “[Diagnostic Commands](#),” in the *WLST Command and Variable Reference*.

Using the WLDF Query Language with the Data Accessor

To query data from data stores, use the WLDF query language. For Data Accessor query language syntax, see [Appendix A, “WLDF Query Language.”](#)

Accessing Diagnostic Data Offline

Use the WLST `exportDiagnosticData` command to access historical diagnostic data from an offline server. For the syntax and examples of this command, see “[Diagnostic Commands](#),” in the *WLST Command and Variable Reference*.

Notes: You can use `exportDiagnosticData` to access archived data only from the machine on which the data is persisted.

You cannot discover data store instances using the offline mode of the Data Accessor. You must already know what they are.

Accessing Diagnostic Data Programmatically

[Listing 12-1](#) shows the source Java code for a utility that uses the Accessor to query the different archive data stores.

Listing 12-1 Sample Code to Use the WLDF Accessor

```
/*
 * WLAccessor.java
 *
 * Demonstration utility that allows query of the different ARCV data stores
 * via the WLDF Accessor.
 *
 */

import javax.naming.Context;
```

```

import weblogic.jndi.Environment;
import java.util.Hashtable;
import java.util.Iterator;
import java.util.Properties;
import weblogic.management.ManagementException;
import weblogic.management.runtime.WLDFAccessRuntimeMBean;
import weblogic.management.runtime.WLDFDataAccessRuntimeMBean;
import weblogic.diagnostics.accessor.ColumnInfo;
import weblogic.diagnostics.accessor.DataRecord;
import java.io.File;
import java.io.FileInputStream;
import java.io.FileNotFoundException;
import java.io.IOException;

import javax.management.MBeanServerConnection;
import javax.management.remote.JMXConnector;
import javax.management.remote.JMXConnectorFactory;
import javax.management.remote.JMXServiceURL;
import javax.management.ObjectName;
import weblogic.management.mbeanservers.runtime.RuntimeServiceMBean;
import weblogic.management.runtime.ServerRuntimeMBean;
import weblogic.management.jmx.MBeanServerInvocationHandler;
import weblogic.management.configuration.ServerMBean;

/**
 * Demonstration utility that allows query of the different ARCV data stores
 * via the WLDF Accessor. The class looks up the appropriate accessor and
 * executes the query given the specified query parameters.
 *
 * To see information about it's usage, compile this file and run
 *
 * java WLAccessor usage
 */
public class WLAccessor {

    /** Creates a new instance of WLAccessor */
    public WLAccessor(Properties p) {

```

Accessing Diagnostic Data With the Data Accessor

```
initialize(p);
}

/**
 * Retrieve the specified WLDfDataAccessRuntimeMBean instance for querying.
 */
public WLDfDataAccessRuntimeMBean getAccessor(String accessorType)
throws Throwable
{
    // Get the runtime MBeanServerConnection
    MBeanServerConnection runtimeMBS =
this.getRuntimeMBeanServerConnection();

    // Lookup the runtime service for the connected server
    ObjectName rtSvcObjName = new
ObjectName(RuntimeServiceMBean.OBJECT_NAME);
    RuntimeServiceMBean rtService = null;

    rtService = (RuntimeServiceMBean)
        MBeanServerInvocationHandler.newProxyInstance(
            runtimeMBS, rtSvcObjName
        );

    // Walk the Runtime tree to the desired accessor instance.
    ServerRuntimeMBean srt = rtService.getServerRuntime();

    WLDfDataAccessRuntimeMBean ddar =
        srt.getWLDfRuntime().getWLDfAccessRuntime().
        lookupWLDfDataAccessRuntime(accessorType);

    return ddar;
}

/**
 * Execute the query using the given parameters, and display the formatted
 * records.
 */
public void queryEventData() throws Throwable
```



```

{
    String logicalName = "EventsDataArchive";
    WLDFDataAccessRuntimeMBean accessor = getAccessor(accessorType);

    ColumnInfo[] colinfo = accessor.getColumns();
    inform("Query string: " + queryString);

    int recordsFound = 0;
    Iterator actualIt =
        accessor.retrieveDataRecords(beginTime, endTime, queryString);
    while (actualIt.hasNext()) {
        DataRecord rec = (DataRecord)actualIt.next();
        inform("Record[" + recordsFound + "]: {");
        Object[] values = rec.getValues();
        for (int colno=0; colno < values.length; colno++) {
            inform("[ " + colno + " ] "
                + colinfo[colno].getColumnName() +
                " (" + colinfo[colno].getColumnTypeName() + "): " +
                values[colno]);
        }
        inform("}");
        inform("");
        recordsFound++;
    }
    inform("Found " + recordsFound + " results");
}

/**
 * Main method that implements the tool.
 * @param args the command line arguments
 */
public static void main(String[] args) {
    try {
        WLAccessor acsr = new WLAccessor(handleArgs(args));
        acsr.queryEventData();
    } catch (UsageException uex) {
        usage();
    } catch (Throwable t) {

```

Accessing Diagnostic Data With the Data Accessor

```
        inform("Caught exception, " + t.getMessage(), t);
        inform("");
        usage();
    }
}

public static class UsageException extends Exception {}

/**
 * Process the command line arguments, which are provided as name/value
pairs.
 */
public static Properties handleArgs(String[] args) throws Exception
{
    Properties p = checkForDefaults();
    for (int i = 0; i < args.length; i++) {
        if (args[i].equalsIgnoreCase("usage"))
            throw new UsageException();

        String[] nvpair = new String[2];
        int token = args[i].indexOf('=');
        if (token < 0)
            throw new Exception("Invalid argument, " + args[i]);
        nvpair[0] = args[i].substring(0,token);
        nvpair[1] = args[i].substring(token+1);
        p.put(nvpair[0], nvpair[1]);
    }
    return p;
}

/**
 * Look for a default properties file
 */
public static Properties checkForDefaults() throws IOException {
    Properties defaults = new Properties();
    try {
        File defaultprops = new File("accessor-defaults.properties");
        FileInputStream defaultsIS = new FileInputStream(defaultprops);
```

```

        //inform("loading options from accessor-defaults.properties");
        defaults.load(defaultsIS);
    } catch (FileNotFoundException fnfex) {
        //inform("No accessor-defaults.properties found");
    }
    return defaults;
}
public static void inform(String s) {
    System.out.println(s);
}
public static void inform(String s, Throwable t) {
    System.out.println(s);
    t.printStackTrace();
}

private MBeanServerConnection getRuntimeMBeanServerConnection()
    throws IOException
{
    // construct jmx service url

    // "service:jmx:[url]/jndi/[mbeanserver-jndi-name]"
    JMXServiceURL serviceURL =
        new JMXServiceURL(
            "service:jmx:" + getServerUrl() +
            "/jndi/" + RuntimeServiceMBean.MBEANSERVER_JNDI_NAME
        );

    // specify the user and pwd. Also specify weblogic provide package
    inform("user name [" + username + "]);
    inform("password [" + password + "]);
    Hashtable h = new Hashtable();
    h.put(Context.SECURITY_PRINCIPAL, username);
    h.put(Context.SECURITY_CREDENTIALS, password);
    h.put(JMXConnectorFactory.PROTOCOL_PROVIDER_PACKAGES,
        "weblogic.management.remote");
    // get jmx connector
    JMXConnector connector = JMXConnectorFactory.connect(serviceURL, h);

```

Accessing Diagnostic Data With the Data Accessor

```
        inform("Using JMX Connector to connect to " + serviceURL);
        return connector.getMBeanServerConnection();
    }

    private void initialize(Properties p) {
        serverUrl = p.getProperty("url", "t3://localhost:7001");
        username = p.getProperty("user", "weblogic");
        password = p.getProperty("pass", "weblogic");
        queryString = p.getProperty("query", "SEVERITY IN
('Error', 'Warning', 'Critical', 'Emergency')");
        accessorType = p.getProperty("type", "ServerLog");

        try {
            beginTime = Long.parseLong(p.getProperty("begin", "0"));

            String end = p.getProperty("end");
            endTime = (end==null) ? Long.MAX_VALUE : Long.parseLong(end);
        } catch (NumberFormatException nfex) {
            throw new RuntimeException("Error formatting time bounds", nfex);
        }
    }

    private static void usage() {
        inform("");
        inform("");
        inform("Usage: ");
        inform("");
        inform("  java WLAccessor [options]");
        inform("");
        inform("where [options] can be any combination of the following: ");
        inform("");
        inform("  usage                Prints this text and exits");
        inform("  url=<url>            default: 't3://localhost:7001'");
        inform("  user=<username>      default: 'weblogic'");
        inform("  pass=<password>      default: 'weblogic'");
        inform("  begin=<begin-timestamp> default: 0");
        inform("  end=<end-timestamp>  default: Long.MAX_VALUE");
        inform("  query=<query-string> default: \"SEVERITY IN
```

```

('Error', 'Warning', 'Critical', 'Emergency')\");
    inform("    type=<accessor-type>    default: 'ServerLog'");
    inform("");
    inform("Example:");
    inform("");
    inform("    java WLAccessor user=system pass=gumby1234
url=http://myhost:8000 \");
    inform("        query=\"SEVERITY = 'Error'\\" begin=1088011734496
type=ServerLog");
    inform("");
    inform("");
    inform("");
    inform("All properties (except \"usage\") can all be specified in a file
");
    inform("in the current working directory. The file must be named: ");
    inform("");
    inform("        \"accessor-defaults.properties\");
    inform("");
    inform("Each property specified in the defaults file can still be ");
    inform("overridden on the command-line as shown above");
    inform("");
}

/** Getter for property serverUrl.
 * @return Value of property serverUrl.
 *
 */
public java.lang.String getServerUrl() {
    return serverUrl;
}

/** Setter for property serverUrl.
 * @param serverUrl New value of property serverUrl.
 *
 */
public void setServerUrl(java.lang.String serverUrl) {
    this.serverUrl = serverUrl;
}

```

```
protected String serverName = null;
protected String username = null;
protected String password = null;
protected String queryString = "";
private String serverUrl = "t3://localhost:7001";
private String accessorType = null;

private long endTime = Long.MAX_VALUE;
private long beginTime = 0;

private WLDFAccessRuntimeMBean dar = null;
}
```

Resetting the System Clock Can Affect How Data Is Archived and Retrieved

Resetting the system clock to an earlier time while diagnostic data is being written to the WLDF Archive or logs can cause unexpected results when you query that data based on a timestamp. For example, consider the following sequence of events:

1. At 2:00 p.m., a diagnostic event is archived as RECORD_200, with a timestamp of 2:00:00 PM.
2. At 2:30 p.m., a diagnostic event is archived as RECORD_230, with a timestamp of 2:30:00 PM.
3. At 3:00 p.m., the system clock is reset to 2:00 p.m.
4. At 2:15 p.m. (after the clock was reset), a diagnostic event is archived as RECORD_215, with a timestamp of 2:15:00 PM.
5. You issue a query to retrieve records generated between 2:00 and 2:20 p.m.

The query will not retrieve RECORD_215, because the 2:30:00 PM timestamp of RECORD_230 ends the query.

Deploying WLDF Application Modules

The only WebLogic Diagnostic Framework (WLDF) component you can use with applications is Instrumentation. See [“Configuring Application-Scoped Instrumentation” on page 10-17](#).

You configure and manage instrumentation for an application as a diagnostics application module, which is an application-scoped resource. The configuration is persisted in a descriptor file which you deploy with the application. A diagnostic module deployed in this way is available only to the enclosing application. Using application-scoped resources ensures that an application always has access to required resources and simplifies the process of deploying the application to new environments.

You can deploy an application using a deployment plan, which permits dynamic configuration updates.

Note: For instrumentation to be available for an application, instrumentation must be enabled on the server to which the application is deployed. (Server-scoped instrumentation is enabled and disabled in the `<instrumentation>` element of the diagnostics descriptor for the server.)

The following sections describe how to deploy WLDF application modules:

- [“Deploying a Diagnostic Module as an Application-Scoped Resource” on page 13-2](#)
- [“Using Deployment Plans for Dynamically Controlling Instrumentation Configuration” on page 13-3](#)
- [“Using a Deployment Plan: Overview” on page 13-4](#)
- [“Creating a Deployment Plan Using `weblogic.PlanGenerator`” on page 13-5](#)

- “Sample Deployment Plan for Diagnostics” on page 13-6
- “Enabling Hot-Swap Capabilities” on page 13-7
- “Deploying an Application with a Deployment Plan” on page 13-7
- “Updating an Application with a Modified Plan” on page 13-8

Deploying a Diagnostic Module as an Application-Scoped Resource

To deploy a diagnostic module as an application-scoped resource, you configure the module in a descriptor file named `weblogic-diagnostics.xml`. You then package the descriptor file with the application archive in the `ARCHIVE_PATH/META-INF` directory for the deployed application. For example:

```
D:\bea\wlserver_10.3\samples\server\medrec\dist\standalone\exploded\medrec
\META-INF\weblogic-diagnostics.xml
```

You can deploy the diagnostic module in both exploded and unexploded archives.

Note: If the EAR archive contains WAR, RAR or EJB modules that have the `weblogic-diagnostics.xml` descriptors in their `META-INF` directory, those descriptors are ignored.

You can use any of the standard WebLogic Server tools provided for controlling deployment, including the WebLogic Administrative Console or the WebLogic Scripting Tool (WLST).

For information on creating modules and deploying applications, see [Deploying Applications to WebLogic Server](#).

Because of the different ways that diagnostic application modules and diagnostic system modules are deployed, there are some differences in how you can reconfigure them and when those changes take place, as shown in [Table 13-1](#). The details of how to work with diagnostic application modules is described throughout this section. See [Chapter 10, “Configuring Instrumentation,”](#) for information about working with diagnostic system modules.

Table 13-1 Comparing System and Application Modules

Module Type	Add/Remove Objects Dynamically	Add/Remove Objects with Console	Modify with JMX Remotely	Modify with JSR-88 (non-remote)	Modify with Console
System Module	Yes	Yes	Yes	No	Yes - via JMX
Application Module	Yes, when hot swap ¹ is enabled No, when hot swap is not enabled: module must be redeployed	Yes	No	Yes	Yes - via plan

1. See [“Using Deployment Plans for Dynamically Controlling Instrumentation Configuration”](#) for information about hot swap.

Using Deployment Plans for Dynamically Controlling Instrumentation Configuration

WebLogic Server supports deployment plans, as specified in the J2EE Deployment Specification API (JSR-88). With deployment plans, you can modify an application’s configuration after the application is built, without having to modify the application archives. For complete documentation on using deployment plans in WebLogic Server, see [“Configuring Applications for Production Deployment”](#) in *Deploying Applications to WebLogic Server*.

If you want to reconfigure an application that was deployed without a deployment plan, you must undeploy, unarchive, reconfigure, re-archive, and then redeploy the application. With a configuration plan, you can dynamically change many configuration options simply by updating the plan, without modifying the application archive.

If you enable a feature called “hot swap” (see [“Enabling Hot-Swap Capabilities”](#)) before deploying your application with a deployment plan, you can dynamically update all instrumentation settings without redeploying the application. If you do not enable hot swap, or if you do not use a deployment plan, changes to some instrumentation settings require redeployment, as shown in [Table 13-2](#).

Table 13-2 When Application Instrumentation Configuration Changes Take Effect

	Add and remove monitors	Attach and detach actions	Enable and disable monitors
Application deployed with a deployment plan, hot swap enabled	Dynamic	Dynamic	Dynamic
Application deployed with a deployment plan, hot swap not enabled	Must redeploy application ¹	Dynamic	Dynamic
Application deployed without a deployment plan	Must redeploy application	Must redeploy application	Must redeploy application

1. If hot-swap is not enabled, you can “remove” a monitor, but that just disables it. The instrumentation code is still woven into the application code. You cannot re-enable it through a modified plan.

You can use a deployment plan to dynamically update configuration elements without redeploying the application.

- <enabled>
- <dye-filtering-enabled>
- <dye-mask>
- <action>

Using a Deployment Plan: Overview

The general process for creating and using a deployment plan is as follows:

1. Create a well-formed `weblogic-diagnostics.xml` descriptor file for the application.

It is recommended that you create an empty descriptor. That provides full flexibility for dynamically modifying the configuration. It is possible to create monitors in the original descriptor file and then use a deployment plan to override the settings. You will, however, be unable to completely remove monitors without redeploying. If you add monitors using a deployment plan to an empty descriptor, all such monitors can be removed. For

information about configuring diagnostic application modules, see [“Configuring Application-Scoped Instrumentation”](#) on page 10-17.

The schema for `weblogic-diagnostics.xml` is available at <http://www.bea.com/ns/weblogic/weblogic-diagnostics/1.1/weblogic-diagnostics.xsd>.

2. Place the descriptor file `weblogic-diagnostics.xml`, in the top-level `META-INF` directory of the appropriate archive.
3. Create a deployment plan, for example by using `weblogic.PlanGenerator`. See [“Creating a Deployment Plan Using `weblogic.PlanGenerator`”](#) on page 13-5.
4. Start the server, optionally enabling “hot-swap” capability. See [“Enabling Hot-Swap Capabilities”](#) on page 13-7.
5. Deploy the application using the deployment plan. See [“Deploying an Application with a Deployment Plan”](#) on page 13-7).
6. When needed, edit the plan and update the application with the plan. See [“Updating an Application with a Modified Plan”](#) on page 13-8.

Creating a Deployment Plan Using `weblogic.PlanGenerator`

You can use the `weblogic.PlanGenerator` tool to create an initial deployment plan, and interactively override specific properties of the `weblogic-diagnostics.xml` descriptor.

The `PlanGenerator` tool inspects all J2EE deployment descriptors in the selected application, and creates a deployment plan with null variables for all relevant WebLogic Server deployment properties that configure external resources for the application.

To create the plan, use the following syntax:

```
java weblogic.PlanGenerator -plan output-plan.xml [options]  
application-path
```

For example:

```
java weblogic.PlanGenerator -plan foo.plan -dynamics /test/apps/mywar
```

Note: The `-dynamics` options specifies that the plan should be generated to include only those options that can be dynamically updated.

For more information about creating and using deployment plans, see [“Configuring Applications for Production Deployment”](#) in *Deploying Applications to WebLogic Server*.

For more information about using PlanGenerator, see [“weblogic.PlanGenerator Command Line Reference”](#) and [“Exporting an Application for Deployment to New Environments”](#) in *Deploying Applications to WebLogic Server*.

Sample Deployment Plan for Diagnostics

Listing 13-1 shows a simple deployment plan generated using `weblogic.PlanGenerator`. (For readability, some information has been removed.) The plan enables the `Servlet_Before_Service` monitor and attaches to it the actions `DisplayArgumentsAction` and `StackDumpAction`.

Listing 13-1 Sample Deployment Plan

```
<?xml version='1.0' encoding='UTF-8'?>

<deployment-plan xmlns="http://www.bea.com/ns/weblogic/90"
xmlns:xsi="http://www.w3.org/2001/XMLSchema-instance"
global-variables="false">
  <application-name>jsp_expr_root</application-name>

  <variable-definition>
    <!-- Add two additional actions to Servlet_Before_Service monitor -->
    <variable>
      <name>WLDFInstrumentationMonitor_Servlet_Before_Service_Actions_11305055
9713922</name>
      <value>"DisplayArgumentsAction", "StackDumpAction"</value>
    </variable>
    <-- Enable the Servlet_Before_Service monitor -->
    <variable>
      <name>WLDFInstrumentationMonitor_Servlet_Before_Service_Enabled_11305055
9713927</name>
      <value>>true</value>
    </variable>
  </variable-definition>

  <module-override>
    <module-name>jspExpressionWar</module-name>
    <module-type>war</module-type>
    <module-descriptor external="false">
      <root-element>weblogic-web-app</root-element>
      <uri>WEB-INF/weblogic.xml</uri>
    </module-descriptor>
    <module-descriptor external="false">
      <root-element>web-app</root-element>
```

```

<uri>WEB-INF/web.xml</uri>
</module-descriptor>
<module-descriptor external="false">
  <root-element>wldf-resource</root-element>
  <uri>META-INF/weblogic-diagnostics.xml</uri>
  <variable-assignment>
    <name>WLDFInstrumentationMonitor_Servlet_Before_Service_Actions_113050
559713922</name>
    <xpath>/wldf-resource/instrumentation/wldf-instrumentation-monitor/[na
me="Servlet_Before_Service"]/action</xpath>
  </variable-assignment>
  <variable-assignment>
    <name>WLDFInstrumentationMonitor_Servlet_Before_Service_Enabled_1130
50559713927</name>
    <xpath>/wldf-resource/instrumentation/wldf-instrumentation-monitor/[
name="Servlet_Before_Service"]/enabled</xpath>
  </variable-assignment>
</module-descriptor>
</module-override>
<config-root xsi:nil="true"></config-root>
</deployment-plan>

```

For a list and documentation of diagnostic monitors and actions that you can specify in the deployment plan, see [Appendix B, “WLDF Instrumentation Library.”](#)

Enabling Hot-Swap Capabilities

To enable hot-swap capabilities, start the server with the following command line switch:

```
-javaagent:$WL_HOME/server/lib/diagnostics-agent.jar
```

Deploying an Application with a Deployment Plan

To take advantage of the dynamic control provided by a deployment plan, you must deploy the application with the plan.

You can use any of the standard WebLogic Server tools for controlling deployment, including the Administration Console or the WebLogic Scripting Tool (WLST). For example, the following WLST command deploys an application with a corresponding deployment plan.

```
wls:/mydomain/serverConfig> deploy('myApp', './myApp.ear', 'myserver',
'nostage', './plan.xml')
```

After deployment, the effective diagnostic monitor configuration is a combination of the original descriptor, combined with the overridden attribute values from the plan. If the original descriptor did not include a monitor with the given name and the plan overrides an attribute of such a monitor, the monitor is added to the set of monitors to be used with the application. This way, if your application is built with an empty `weblogic-diagnostics.xml` descriptor, you can add diagnostic monitors to the application during or after the deployment process without having to modify the application archive.

Updating an Application with a Modified Plan

You change configuration settings by modifying the deployment plan and then updating or redeploying the application, depending on whether or not hot swap is enabled. (See [Table 13-2](#) to see when you can simply update the application and when you must redeploy it.) You can use any of the standard WebLogic Server tools for updating or redeploying, including the Administration Console or the WebLogic Scripting Tool (WLST).

If you enabled hot-swap, you can update the configuration for the application with the modified plan values by *updating* the application with the plan. For example, the following WLST command updates an application with a plan:

```
wls:/mydomain/serverConfig> updateApplication('BigApp',  
      'c:/myapps/BigApp/newPlan/plan.xml', stageMode='STAGE',  
      testMode='false')
```

If you did not enable hot-swap, you must *redeploy* the application for certain changes to take effect. For example, the following WLST command redeploys an application using a plan:

```
wls:/mydomain/serverConfig> redeploy('myApp' 'c:/myapps/plan.xml')
```

Configuring and Using WLDF Programmatically

As discussed in previous chapters, you can use the WebLogic Server Administration Console to enable, configure, and monitor features of WebLogic Server, including the WebLogic Diagnostic Framework (WLDF). You can do the same tasks programmatically using the JMX API and the WebLogic Scripting Tool (WLST).

The following sections provide information about configuring WLDF programmatically:

- [“How WLDF Generates and Retrieves Data”](#) on page 14-2
- [“Mapping WLDF Components to Beans and Packages”](#) on page 14-2
- [“Programming Tools”](#) on page 14-6
- [“WLDF Packages”](#) on page 14-8
- [“Programming WLDF: Examples”](#) on page 14-9

In addition to the information provided in those sections, use the information in the following manuals to develop and deploy applications, and to use WLST:

- *Developing Applications with WebLogic Server*
- *Developing Manageable Applications with JMX*
- *Developing Custom Management Utilities with JMX*
- *Deploying Applications to WebLogic Server*
- *WebLogic Scripting Tool*

How WLDF Generates and Retrieves Data

In general, diagnostic data is generated and retrieved by WLDF components following this process:

- The WLDF XML descriptor file settings for the Harvester, Instrumentation, Image Capture, and Watch and Notification components determine the type and amount of diagnostic data generated while a server is running.
- The diagnostic context and instrumentation settings filter and monitor this data as it flows through the system. Data is harvested, actions are triggered, events are generated, and configured notifications are sent.
- The Archive component stores the data.
- The Accessor component retrieves the data.

Configuration is primarily an administrative task, accomplished either through the Administration Console or through WLST scripts. Deployable descriptor modules, XML configuration files, are the primary method for configuring diagnostic resources at both the system level (servers and clusters) and at the application level. (For information on configuring WLDF resources, see [Chapter 3, “Understanding WLDF Configuration.”](#))

Output retrieval via the Accessor component can be either an administrative or a programmatic task.

Mapping WLDF Components to Beans and Packages

When you create WLDF resources using the Administration Console or WLST, WebLogic Server creates MBeans (managed beans=) for each resource. You can then access these MBeans using JMX or WLST. Because `weblogic.WLST` is a JMX client; any task you can perform using WLST you can also perform programmatically through JMX.

[Table 14-1](#) lists the beans and packages associated with WLDF and its components. [Figure 14-1](#) groups the beans by type.

Table 14-1 Mapping WLDf Components to Beans and Packages

Component	Beans / Packages
WLDf	WLDfServerDiagnosticMBean WLDfSystemResourceMBean WLDfBean (abstract) WLDfResourceBean WLDfRuntimeMBean
Diagnostic Image	WLDfImageNotificationBean WLDfImageCreationTaskRuntimeMBean WLDfImageRuntimeMBean
Instrumentation	WLDfInstrumentationBean WLDfInstrumentationMonitorBean WLDfInstrumentationRuntimeMBean
Diagnostic Context	Package: weblogic.diagnostics.context DiagnosticContextHelper DiagnosticContextConstants
Harvester	WLDfHarvesterBean WLDfHarvestedTypeBean WLDfHarvesterRuntimeMBean

Table 14-1 Mapping WLDf Components to Beans and Packages (Continued)

Component	Beans / Packages
Watch & Notification	WLDfNotificationBean
	WLDfWatchNotificationBean
	WLDfJMSNotificationBean
	WLDfJMXNotificationBean
	WLDfSMTPNotificationBean
	WLDfSNMPNotificationBean
	WLDfWatchJMXNotificationRuntimeMBean
	WLDfWatchNotificationRuntimeMBean
	Package: <code>weblogic.diagnostics.watch</code>
	JMXWatchNotification
WatchNotification	
Archive	WLDfArchiveRuntimeMBean
	WLDfDbstoreArchiveRuntimeMBean
	WLDfFileArchiveRuntimeMBean
	WLDfWlstoreArchiveRuntimeMBean
Accessor	WLDfAccessRuntimeMBean
	WLDfDataAccessRuntimeMBean

Figure 14-1 WLDf Configuration MBeans, Runtime MBeans, and System Module Beans

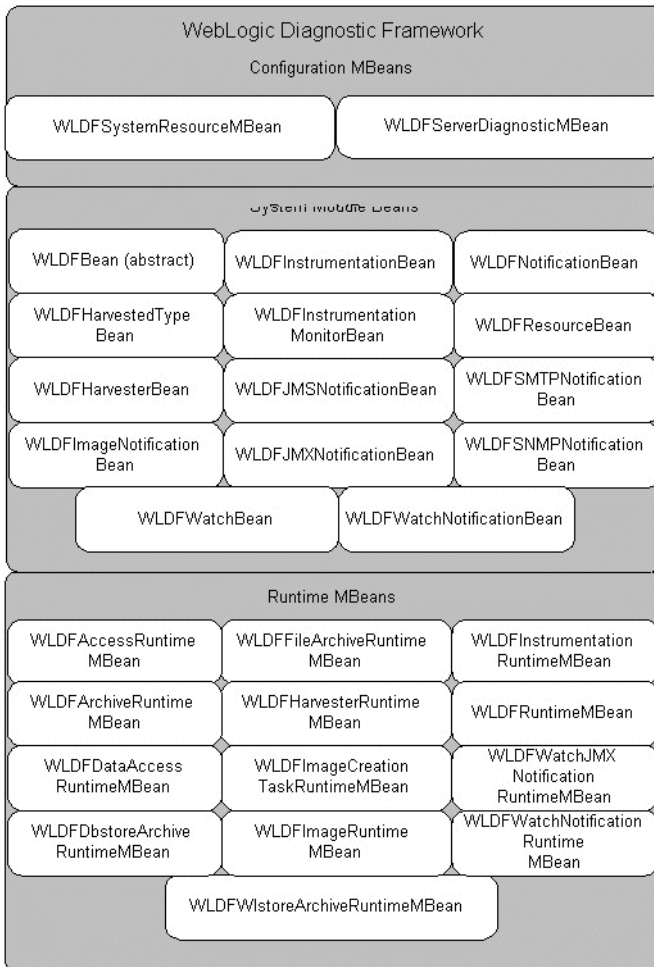

Programming Tools

The WebLogic Diagnostic Framework enables you to perform the following tasks programmatically:

- Create and modify diagnostic descriptor files to configure the WLDF Harvester, Instrumentation, and Watch and Notification components at the server level.
- Use JMX to access WLDF operations and attributes.
- Use JMX to create custom MBeans that contain harvestable data. You can then configure the Harvester to collect that data and configure a watches and notifications to monitor the values.
- Write Java programs that perform the following tasks:
 - Capture notifications using JMX listeners.
 - Capture notifications using JMS.
 - Retrieve archived data through the Accessor. (The Accessor, as are the other components, is surfaced as JMX; you can use WLST or straight JMX programming to retrieve diagnostic data.)

Configuration and Runtime APIs

The configuration and runtime APIs configure and monitor WLDF. Both the configuration and runtime APIs are exposed as MBeans.

- The configuration MBeans and system module Beans create and configure WLDF resources, and determine their runtime behavior.
- The runtime MBeans monitor the runtime state and the operations defined for the different components.

You can use the APIs to configure, activate, and deactivate data collection; to configure watches, notifications, alarms, and diagnostic image captures; and to access data.

Configuration APIs

The Configuration APIs define interfaces that are used to configure the following WLDF components:

- Data Collectors: You can use the configuration APIs to configure and control Instrumentation, Harvesting, and Image Capture.

- For the Instrumentation component, you can enable, disable, create, and destroy server-level instrumentation and instrumentation monitors.
 - Note:** The configuration APIs do not support configuration of application-level instrumentation. However, configuration changes for application-level instrumentation can be effected using Java Specification Request (JSR) 88 APIs.
- For the Harvester component, you can add and remove types to be harvested, specify which attributes and instances of those types are to be harvested, and set the sample period for the harvester.
- For the Diagnostic Image Capture component, you can set the name and path of the directory in which the image capture is to be stored and the events image capture interval, that is, the time interval during which recently archived events are captured in the diagnostic image.
- Watch and Notifications: You can use the configuration APIs to enable, disable, create, and destroy watches and notifications. You can also use the configuration APIs to:
 - Set the rule type, watch-rule expressions, and severity for watches
 - Set alarm type and alarm reset period for notifications
 - Configure a watch to trigger a diagnostic image capture
 - Add and remove notifications from watches
- Archive: Set the archive type and the archive directory

Runtime APIs

The runtime APIs define interfaces that are used to monitor the runtime state of the WLDF components. Instances of these APIs are instantiated on instances of individually managed servers. These APIs are defined as runtime MBeans, so JMX clients can easily access them.

The Runtime APIs encapsulate all other runtime interfaces for the individual WLDF components. These APIs are included in the `weblogic.management.runtime` package.

You can use the runtime APIs to monitor the following WLDF components:

- Data Collectors—You can use the runtime APIs to monitor the Instrumentation, Harvester, and the Image Capture components.
 - For the Instrumentation component, you can monitor joinpoint count statistics, the number of classes inspected for instrumentation monitors, the number of classes modified, and the time it takes to inspect a class for instrumentation monitors.

- For the Harvester component, you can query the set of harvestable types, harvestable attributes, and harvestable instances (that is, the instances that are currently harvestable for specific types). And, you can also query which types, attributes, and instances are currently configured for harvesting. The sampling interval and various runtime statistics pertaining to the harvesting process are also available.
- For the Image Capture component, you can specify the destination and lockout period for diagnostic images and initiate image captures.
- **Watches and Notifications:** You can use the runtime APIs to monitor the Watches and Notifications and Archive components.
 - For the Watches and Notifications component, you can reset watch alarms and monitor statistics about watch-rule evaluations and watches triggered, including information about the analysis of alarms, events, log records, and harvested metrics.
- **Archive:** You can monitor information about the archive, such as file name and archive statistics.
- **Data Accessor—**You can use the runtime APIs to retrieve the diagnostic data persisted in the different archives. The runtime APIs also support data filtering by allowing you to specify a query expression to search the data from the underlying archive. You can monitor information about column type maps (a map relating column names to the corresponding type names for the diagnostic data), statistics about data record counts and timestamps, and cursors (cursors are used by clients to fetch data records).

WLDf Packages

The following two packages are provided:

- `weblogic.diagnostics.context` contains:
 - `DiagnosticContextConstants`, which defines the indices of dye flags supported by the WebLogic diagnostics system.
 - `DiagnosticContextHelper`, which provides applications limited access to the diagnostic context.
- `weblogic.diagnostics.watch` contains:
 - `JMXWatchNotification`, an extended JMX notification object which includes additional information about the notification. This information is contained in the referenced `WatchNotification` object returned from method `getExtendedInfo`.
 - `WatchNotification`, which defines a notification for a watch rule.

Programming WLDf: Examples

The following examples use WLDf beans and packages to access and modify information on a running server:

- “[Example: DiagnosticContextExample.java](#)” on page 14-9
- “[Example: HarvesterMonitor.java](#)” on page 14-10
- “[Example: JMXAccessorExample.java](#)” on page 14-18

In addition, see the WLST and JMX examples in [Appendix D, “WebLogic Scripting Tool Examples.”](#)

Example: DiagnosticContextExample.java

The following example uses the `DiagnosticContextHelper` class from the `weblogic.diagnostics.context` package to get and set the value of the `DYE_0` flag. (For information on diagnostic contexts, see [Chapter 11, “Configuring the DyeInjection Monitor to Manage Diagnostic Contexts.”](#))

To compile and run the program:

1. Copy the `DiagnosticContextExample.java` example ([Listing 14-2](#)) to a directory and compile it with:

```
javac -d . DiagnosticContextExample.java
```

This will create the `./weblogic/diagnostics/examples` directory and populate it with `DiagnosticContextExample.class`.

2. Run the program. The command syntax is:

```
java weblogic.diagnostics.examples.DiagnosticContextExample
```

Sample output is similar to:

```
# java weblogic.diagnostics.examples.DiagnosticContextExample
ContextId=5b7898f93bf010ce:40305614:1048582efd4:-8000-0000000000000001
isDyedWith(DYE_0)=false
isDyedWith(DYE_0)=true
```

Listing 14-1 Example: DiagnosticContextExample.java

```
package weblogic.diagnostics.examples;

import weblogic.diagnostics.context.DiagnosticContextHelper;

public class DiagnosticContextExample {

    public static void main(String args[]) throws Exception {
        System.out.println("ContextId=" +
            DiagnosticContextHelper.getContextId());
        System.out.println("isDyedWith(DYE_0)=" +
            DiagnosticContextHelper.isDyedWith(DiagnosticContextHelper.DYE_0));

        DiagnosticContextHelper.setDye(DiagnosticContextHelper.DYE_0, true);
        System.out.println("isDyedWith(DYE_0)=" +
            DiagnosticContextHelper.isDyedWith(DiagnosticContextHelper.DYE_0));
    }
}
```

Example: HarvesterMonitor.java

The `HarvesterMonitor` program uses the `Harvester` JMX notification to identify when a harvest cycle has occurred. It then retrieves the new values using the `Accessor`. All access is performed through JMX. This section includes a description of notification listeners followed by the `HarvesterMonitor.java` code:

- [“Notification Listeners” on page 14-10](#)
- [“HarvesterMonitor.java” on page 14-11](#)

For information on the `Harvester` component, see [Chapter 6, “Configuring the Harvester for Metric Collection.”](#)

Notification Listeners

Notification listeners provide an appropriate implementation for a particular transport medium. For example, SMTP notification listeners provide the mechanism to establish an SMTP connection with a mail server and trigger an e-mail with the notification instance that it receives. JMX, SNMP, JMS and other types of listeners provide their respective implementations as well.

Note: You can develop plug-ins that propagate events generated by the WebLogic Diagnostic Framework using transport mediums other than SMTP, JMX, SNMP, or JMS. One

approach is to use the `JMX NotificationListener` interface to implement an object, and then propagate the notification according to the requirements of the selected transport medium.

[Table 14-2](#) describes each notification listener type that is provided with WebLogic Server and the relevant configuration settings for each type.

Table 14-2 Notification Listener Types

Notification Medium	Description	Configuration Parameter Requirements
JMS	Propagated via JMS Message queues or topics.	Required: Destination JNDI name. Optional: Connection factory JNDI name (use the default JMS connection factory if not present).
JMX	Propagated via standard JMX notifications.	None required. Uses predefined singleton for posting the event.
SMTP	Propagated via regular e-mail.	Required: MailSession JNDI name and Destination e-mail. Optional: Subject and body (if not specified, use default)
SNMP	Propagated via SNMP traps and the WebLogic Server SNMP Agent.	None required, but the <code>SNMPTrapDestination</code> MBean must be defined in the WebLogic SNMP agent.

By default, all notifications fired from watch rules are stored in the server log file in addition to being fired through the configured medium.

HarvesterMonitor.java

To compile and run the `HarvesterMonitor` program:

1. Copy the `HarvesterMonitor.java` example ([Listing 14-2](#)) to a directory and compile it with:

```
javac -d . HarvesterMonitor.java
```

This will create the `./weblogic/diagnostics/examples` directory and populate it with `HarvesterMonitor.class` and `HarvesterMonitor$HarvestCycleHandler.class`.

2. Start the monitor. The command syntax is:

```
java HarvesterMonitor <server> <port> <uname> <pw> [<types>]
```

You will need access to a WebLogic Server instance, and will need to know the server's name, port number, administrator's login name, and the administrator's password.

You can provide an optional list of harvested type names. If provided, the program will display only the values for those types. However, for each selected type, the monitor displays the complete set of collected values; there is no way to constrain the values that are displayed for a selected type.

Only values that are explicitly configured for harvesting are displayed. Values collected solely to support watch rules (implicit values) are not displayed.

The following command requires that '.' is in the CLASSPATH variable, and that you run the command from the directory where you compiled the program. The command connects to the myserver server, at port 7001, as user weblogic, with a password of weblogic:

```
java weblogic.diagnostics.examples.HarvesterMonitor myserver 7001
    weblogic weblogic
```

See [Listing 14-3](#) for an example of output from the HarvesterMonitor.

Listing 14-2 Example: HarvesterMonitor.java

```
package weblogic.diagnostics.examples;

import weblogic.management.mbeanservers.runtime.RuntimeServiceMBean;

import javax.management.*;
import javax.management.remote.*;
import javax.naming.Context;
import java.util.*;

public class HarvesterMonitor {

    private static String accessorRuntimeMBeanName;
    private static ObjectName accessorRuntimeMBeanObjectName;

    private static String harvRuntimeMBeanName;
    private static ObjectName harvRuntimeMBeanObjectName;

    private static MBeanServerConnection rmbs;

    private static ObjectName getObjectName(String objectNameStr) {
        try { return new ObjectName(getCanonicalName(objectNameStr)); }
        catch (RuntimeException x) { throw x; }
    }
}
```

```

        catch (Exception x) { x.printStackTrace(); throw new
                               RuntimeException(x); }
    }

    private static String getCanonicalName(String objectNameStr) {
        try { return new ObjectName(objectNameStr).getCanonicalName(); }
        catch (RuntimeException x) { throw x; }
        catch (Exception x) { x.printStackTrace(); throw new
                               RuntimeException(x); }
    }

    private static String serverName;
    private static int port;
    private static String userName;
    private static String password;

    private static ArrayList typesToMonitor = null;

    public static void main(String[] args) throws Exception {
        if (args.length < 4) {
            System.out.println(
                "Usage: java weblogic.diagnostics.harvester.HarvesterMonitor " +
                "<serverName> <port> <userName> <password> [<types>]" +
                weblogic.utils.PlatformConstants.EOL +
                " where <types> (optional) is a comma-separated list " +
                "of types to monitor.");
            System.exit(1);
        }

        serverName = args[0];
        port = Integer.parseInt(args[1]);
        userName = args[2];
        password = args[3];

        accessorRuntimeMBeanName = getCanonicalName(
            "com.bea:ServerRuntime=" + serverName +
            ",Name=HarvestedDataArchive,Type=WLDFDataAccessRuntime" +
            ",WLDFAccessRuntime=Accessor,WLDFRuntime=WLDFRuntime");
        accessorRuntimeMBeanObjectName =
            getObjectMBeanName(accessorRuntimeMBeanName);
    }

```

Configuring and Using WLDF Programmatically

```
harvRuntimeMBeanName = getCanonicalName(
    "com.bea:ServerRuntime=" + serverName +
    ",Name=WLDFHarvesterRuntime,Type=WLDFHarvesterRuntime" +
    ",WLDFRuntime=WLDFRuntime");
harvRuntimeMBeanObjectName = getObjectNames(harvRuntimeMBeanName);

if (args.length > 4) {
    String typesStr = args[4];
    typesToMonitor = new ArrayList();
    int index;
    while ((index = typesStr.indexOf(",") > 0) {
        String typeName = typesStr.substring(0,index).trim();
        typesToMonitor.add(typeName);
        typesStr = typesStr.substring(index+1);
    }
    typesToMonitor.add(typesStr.trim());
}

rmbs = getRuntimeMBeanServerConnection();

new HarvesterMonitor().new HarvestCycleHandler();
while(true) {Thread.sleep(100000);}
}

static protected String JNDI = "/jndi/";
static public MBeanServerConnection getRuntimeMBeanServerConnection()
    throws Exception {
    JMXServiceURL serviceURL;
    serviceURL =
        new JMXServiceURL("t3",
            "localhost",
            port,
            JNDI + RuntimeServiceMBean.MBEANSERVER_JNDI_NAME);
    System.out.println("ServerName=" + serverName);
    System.out.println("URL=" + serviceURL);

    Hashtable h = new Hashtable();
    h.put(Context.SECURITY_PRINCIPAL, userName);
    h.put(Context.SECURITY_CREDENTIALS, password);
    h.put(JMXConnectorFactory.PROTOCOL_PROVIDER_PACKAGES,
```

```

        "weblogic.management.remote");
    JMXConnector connector = JMXConnectorFactory.connect(serviceURL,h);
    return connector.getMBeanServerConnection();
}

class HarvestCycleHandler implements NotificationListener {
    // used to track harvest cycles

    private int timestampIndex;
    private int domainIndex;
    private int serverIndex;
    private int typeIndex;
    private int instNameIndex;
    private int attrNameIndex;
    private int attrTypeIndex;
    private int attrValueIndex;

    long lastSampleTime = System.currentTimeMillis();

    HarvestCycleHandler() throws Exception{
        System.out.println("Harvester monitor started...");
        try {
            setUpRecordIndices();
            rmbs.addNotificationListener(harvRuntimeMBeanObjectName,
                                        this, null, null);
        }
        catch (javax.management.InstanceNotFoundException x) {
            System.out.println("Cannot find JMX data. " +
                               "Is the server name correct?");
            System.exit(1);
        }
    }

    private void setUpRecordIndices() throws Exception {
        Map columnIndexMap = (Map)rmbs.getAttribute(
            accessorRuntimeMBeanObjectName, "ColumnIndexMap");

        timestampIndex =
            ((Integer)columnIndexMap.get("TIMESTAMP")).intValue();
        domainIndex =
            ((Integer)columnIndexMap.get("DOMAIN")).intValue();
    }
}

```

Configuring and Using WLDF Programmatically

```
serverIndex =
    ((Integer)columnIndexMap.get("SERVER")).intValue();
typeIndex =
    ((Integer)columnIndexMap.get("TYPE")).intValue();
instNameIndex =
    ((Integer)columnIndexMap.get("NAME")).intValue();
attrNameIndex =
    ((Integer)columnIndexMap.get("ATTRNAME")).intValue();
attrTypeIndex =
    ((Integer)columnIndexMap.get("ATTRTYPE")).intValue();
attrValueIndex =
    ((Integer)columnIndexMap.get("ATTRVALUE")).intValue();
}

public synchronized void handleNotification(Notification notification,
                                           Object handback) {

    System.out.println("\n-----");
    long thisSampleTime = System.currentTimeMillis()+1;
    try {
        String lastTypeName = null;
        String lastInstName = null;
        String cursor = (String)rmbms.invoke(accessorRuntimeMBeanObjectName,
                                           "openCursor",
                                           new Object[]{new Long(lastSampleTime),
                                                         new Long(thisSampleTime), null},
                                           new String[]{"java.lang.Long",
                                                         "java.lang.Long", "java.lang.String" } );
        while (((Boolean)rmbms.invoke(accessorRuntimeMBeanObjectName,
                                      "hasMoreData",
                                      new Object[]{cursor},
                                      new String[]{"java.lang.String"})).booleanValue()) {
            Object[] os = (Object[])rmbms.invoke(accessorRuntimeMBeanObjectName,
                                                "fetch",
                                                new Object[]{cursor},
                                                new String[]{"java.lang.String"});
            for (int i = 0; i < os.length; i++) {
                Object[] values = (Object[])os[i];
                String typeName = (String)values[typeIndex];
```

```

String instName = (String)values[instNameIndex];
String attrName = (String)values[attrNameIndex];
if (!typeName.equals(lastTypeName)) {
    if (typesToMonitor != null &&
        !typesToMonitor.contains(typeName)) continue;
    System.out.println("\nType " + typeName);
    lastTypeName = typeName;
}
if (!instName.equals(lastInstName)) {
    System.out.println("\n Instance " + instName);
    lastInstName = instName;
}
Object attrValue = values[attrValueIndex];
System.out.println("    - " + attrName + "=" + attrValue);
}
}
lastSampleTime = thisSampleTime;
}
catch (Exception e) {e.printStackTrace();}
}
}
}

```

[Listing 14-3](#) contains sample output from the HarvesterMonitor program:

Listing 14-3 Sample Output from HarvesterMonitor

```

ServerName=myserver
URL=service:jmx:t3://localhost:7001/jndi/weblogic.management.mbeanservers.
runtime
Harvester monitor started...

-----

Type weblogic.management.runtime.WLDFHarvesterRuntimeMBean
Instance com.bea:Name=WLDFHarvesterRuntime,ServerRuntime=myserver,Type=WLD
FHarvesterRuntime,WLDFRuntime=WLDFRuntime

```

Configuring and Using WLDf Programmatically

```
- TotalSamplingTime=202048863
- CurrentSnapshotElapsedTime=1839619
Type weblogic.management.runtime.ServerRuntimeMBean
Instance com.bea:Name=myserver,Type=ServerRuntime
- RestartRequired=false
- ListenPortEnabled=true
- ActivationTime=1118319317071
- ServerStartupTime=40671
- ServerClasspath= [deleted long classpath listing]
- CurrentMachine=
- SocketsOpenedTotalCount=1
- State=RUNNING
- RestartsTotalCount=0
- AdminServer=true
- AdminServerListenPort=7001
- ClusterMaster=false
- StateVal=2
- CurrentDirectory=C:\testdomain\
- AdminServerHost=10.40.8.123
- OpenSocketsCurrentCount=1
- ShuttingDown=false
- SSLListenPortEnabled=false
- AdministrationPortEnabled=false
- AdminServerListenPortSecure=false
- Registered=true
```

Example: JMXAccessorExample.java

The following example program uses JMX to print log entries to standard out. All access is performed through JMX. (For information on the Accessor component, see [Chapter 12, “Accessing Diagnostic Data With the Data Accessor.”](#))

To compile and run the program:

1. Copy the JMXAccessorExample.java example ([Listing 14-4](#)) to a directory and compile it with:

```
javac -d . JMXAccessorExample.java
```

This will create the `./weblogic/diagnostics/examples` directory and populate it with `JMXAccessorExample.class`.

2. Start the program. The command syntax is:

```
java weblogic.diagnostics.example.JMXAccessor <logicalName> <query>
```

You will need access to a WebLogic Server instance, and will need to know the server's name, port number, administrator's login name, and the administrator's password.

The `logicalName` is the name of the log. Valid names are: `HarvestedDataArchive`, `EventsDataArchive`, `ServerLog`, `DomainLog`, `HTTPAccessLog`, `ServletAccessorHelper.WEBAPP_LOG`, `RAUtil.CONNECTOR_LOG`, `JMSMessageLog`, and `CUSTOM`.

The `query` is constructed using the syntax described in [Appendix A, "WLDF Query Language."](#) For the `JMXAccessorExample` program, an empty query (an empty pair of double quotation marks, `" "`) returns all entries in the log.

The following command requires that `'.'` is in the `CLASSPATH` variable, and that you run the command from the directory where you compiled the program. The program uses the IIOP (Internet Inter-ORB Protocol) protocol to connect to port 7001, as user `weblogic`, with a password of `weblogic`, and prints all entries in the `ServerLog` to standard out:

```
java weblogic.diagnostics.examples.JMXAccessorExample ServerLog ""
```

You can modify the example to use a username/password combination for your site.

Listing 14-4 JMXAccessorExample.java

```
package weblogic.diagnostics.examples;

import java.io.IOException;
import java.net.MalformedURLException;
import java.util.Hashtable;
import java.util.Iterator;
import javax.management.MBeanServerConnection;
import javax.management.MalformedObjectNameException;
import javax.management.ObjectName;
import javax.management.remote.JMXConnector;
import javax.management.remote.JMXConnectorFactory;
import javax.management.remote.JMXServiceURL;
import javax.naming.Context;
```

Configuring and Using WLDF Programmatically

```
public class JMXAccessorExample {
    private static final String JNDI = "/jndi/";

    public static void main(String[] args) {
        try {
            if (args.length != 2) {
                System.err.println("Incorrect invocation. Correct usage is:\n" +
                    "java weblogic.diagnostics.examples.JMXAccessorExample " +
                    "<logicalName> <query>");
                System.exit(1);
            }
            String logicalName = args[0];
            String query = args[1];

            MBeanServerConnection mbeanServerConnection =
                lookupMBeanServerConnection();
            ObjectName service = new
                ObjectName(weblogic.management.mbeanservers.runtime.RuntimeServic
eMBean.OBJECT_NAME);
            ObjectName serverRuntime =
                (ObjectName) mbeanServerConnection.getAttribute(service,
                    "ServerRuntime");
            ObjectName wldfRuntime =
                (ObjectName) mbeanServerConnection.getAttribute(serverRuntime,
                    "WLDFRuntime");
            ObjectName wldfAccessRuntime =
                (ObjectName) mbeanServerConnection.getAttribute(wldfRuntime,
                    "WLDFAccessRuntime");
            ObjectName wldfDataAccessRuntime =
                (ObjectName) mbeanServerConnection.invoke(wldfAccessRuntime,
                    "lookupWLDFDataAccessRuntime", new Object[] {logicalName},
                    new String[] {"java.lang.String"});

            String cursor =
                (String) mbeanServerConnection.invoke(wldfDataAccessRuntime,
                    "openCursor", new Object[] {query},
                    new String[] {"java.lang.String"});

            int fetchedCount = 0;
            do {
```

```

Object[] rows =
    (Object[]) mbeanServerConnection.invoke(wldfDataAccessRuntime,
        "fetch", new Object[] {cursor},
        new String[] {"java.lang.String"});

fetchedCount = rows.length;

for (int i=0; i<rows.length; i++) {
    StringBuffer sb = new StringBuffer();
    Object[] cols = (Object[]) rows[i];
    for (int j=0; j<cols.length; j++) {
        sb.append("Index " + j + "=" + cols[j].toString() + " ");
    }
    System.out.println("Found row = " + sb.toString());
}
} while (fetchedCount > 0);

mbeanServerConnection.invoke(wldfDataAccessRuntime,
    "closeCursor", new Object[] {cursor},
    new String[] {"java.lang.String"});

} catch(Throwable th) {
    th.printStackTrace();
    System.exit(1);
}
}

private static MBeanServerConnection lookupMBeanServerConnection ()
    throws Exception {

    // construct JMX service URL
    JMXServiceURL serviceURL;
    serviceURL = new JMXServiceURL("iiop", "localhost", 7001,
        JNDI + "weblogic.management.mbeanservers.runtime");

    // Specify the user, password, and WebLogic provider package
    Hashtable h = new Hashtable();
    h.put(Context.SECURITY_PRINCIPAL, "weblogic");
    h.put(Context.SECURITY_CREDENTIALS, "weblogic");
    h.put(JMXConnectorFactory.PROTOCOL_PROVIDER_PACKAGES,
        "weblogic.management.remote");
}

```

Configuring and Using WLDf Programmatically

```
// Get jmx connector
JMXConnector connector = JMXConnectorFactory.connect(serviceURL,h);

// return MBean server connection class
return connector.getMBeanServerConnection();
} // End - lookupMBeanServerConnection
}
```

WLDF Query Language

WLDF includes a query language for constructing watch rule expressions, Data Accessor query expressions, and log filter expressions. The syntax is a small and simplified subset of SQL syntax.

The language is described in the following sections:

- [“Components of a Query Expression” on page A-2](#)
- [“Supported Operators” on page A-2](#)
- [“Operator Precedence” on page A-3](#)
- [“Numeric Relational Operations Supported on String Column Types” on page A-4](#)
- [“Supported Numeric Constants and String Literals” on page A-4](#)
- [“Creating Watch Rule Expressions” on page A-5](#)
- [“Creating Data Accessor Queries” on page A-9](#)
- [“Creating Log Filter Expressions” on page A-12](#)
- [“Building Complex Expressions” on page A-13](#)

Components of a Query Expression

A query expression may include:

- Operators. (See [“Supported Operators”](#) on page A-2.)
- Literals. (See [“Supported Numeric Constants and String Literals”](#) on page A-4.)
- Variables. The supported variables differ for each type of expression. (See [“About Variables in Expressions”](#) on page A-5.)

The query language is case-sensitive.

Supported Operators

The query language supports the operators listed in [Table A-1](#).

Table A-1 WLDF Query Language Operators

Operator	Operator Type	Supported Operand Types	Definition
AND	Logical binary	Boolean	Evaluates to true when both expressions are true.
OR	Logical binary	Boolean	Evaluates to true when either expression is true.
NOT	Logical unary	Boolean	Evaluates to true when the expression is not true.
&	Bitwise binary	Numeric, Dye flag	<p>Performs the bitwise AND function on each parallel pair of bits in each operand. If <i>both</i> operand bits are 1, the & function sets the resulting bit to 1. Otherwise, the resulting bit is set to 0.</p> <p>Examples of both the & and the operators are:</p> $1010 \ \& \ 0010 = 0010$ $1010 \ \ 0001 = 1011$ $(\ 1010 \ \& \ (\ 1100 \ \ 1101 \)) = 1000$
	Bitwise binary	Numeric, Dye flag	<p>Performs the bitwise OR function on each parallel pair of bits in each operand. If <i>either</i> operand bit is 1, the function sets the resulting bit to 1. Otherwise, the resulting bit is set to 0.</p> <p>For examples, see the entry for the bitwise & operator, above.</p>

Table A-1 WLDf Query Language Operators (Continued)

Operator	Operator Type	Supported Operand Types	Definition
=	Relational	Numeric, String	Equals
!=	Relational	Numeric	Not equals
<	Relational	Numeric	Less than
>	Relational	Numeric	Greater than
<=	Relational	Numeric	Less than or equals
>=	Relational	Numeric	Greater than or equals
LIKE	Match	String	Evaluates to true when a character string matches a specified pattern that can include wildcards. LIKE supports two wildcard characters: A percent sign (%) matches any string of zero or more characters A period (.) matches any single character
MATCHES	Match	String	Evaluates to true when a target string matches the regular expression pattern in the operand string.
IN	Search	String	Evaluates to true when the value of a variable exists in a predefined set, for example: SUBSYSTEM IN ('A', 'B')

Operator Precedence

The following list shows the levels of precedence among operators, from the highest precedence to the lowest. Operators listed on the same line have equivalent precedence:

1. ()
2. NOT
3. &, |
4. =, !=, <, >, <=, >=, LIKE, MATCHES, IN

5. AND

6. OR

Numeric Relational Operations Supported on String Column Types

Numeric relational operations can be performed on String column types when they hold numeric values. For example, if `STATUS` is a String type, while performing relational operations with a numeric operand, the column value is treated as a numeric value. For instance, in the following comparisons:

```
STATUS = 100
STATUS != 100
STATUS < 100
STATUS <= 100
STATUS > 100
STATUS >= 100
```

the query evaluator attempts to convert the string value to appropriate numeric value before comparison. When the string value cannot be converted to a numeric value, the query fails.

Supported Numeric Constants and String Literals

Rules for numeric constants are as follows:

- Numeric literals can be integers or floating point numbers.
- Numeric literals are specified the same as in Java. Some examples of numeric literals are 2, 2.0, 12.856f, 2.1934E-4, 123456L and 2.0D.

Rules for string literals are as follows:

- String literals must be enclosed in single quotes.
- A percent character (%) can be used as a wildcard inside string literals.
- An underscore character (_) can be used as a wildcard to stand for any single character.
- A backslash character (\) can be used to escape special characters, such as a quote (') or a percent character (%).

- For watch rule expressions, you can use comparison operators to specify threshold values for String, Integer, Long, Double, Boolean literals.
- The relational operators do a lexical comparison for Strings. For more information, see the documentation for the `java.lang.String.compareTo(String str)` method.

About Variables in Expressions

Variables represent the dynamic portion of a query expression that is evaluated at runtime. You must use variables that are appropriate for the type of expression you are constructing, as documented in the following sections:

- [“Creating Watch Rule Expressions” on page A-5](#)
- [“Creating Data Accessor Queries” on page A-9](#)
- [“Creating Log Filter Expressions” on page A-12](#)

Creating Watch Rule Expressions

You can create watches based on log events, instrumentation events, and harvested attributes. The variables supported for creating the expressions are different for each type of watch, as described in the following sections:

- [“Creating Log Event Watch Rule Expressions” on page A-6](#)
- [“Creating Instrumentation Event Watch Rule Expressions” on page A-7](#)
- [“Creating Harvester Watch Rule Expressions” on page A-8](#)

For complete documentation about configuring and using WLDF watches, see:

- [Chapter 7, “Configuring Watches and Notifications”](#)
- [Chapter 8, “Configuring Watches”](#)

Creating Log Event Watch Rule Expressions

A *log event* watch rule expression is based upon the attributes of a log message from the server log.

Variable names for log message attributes are listed and explained in [Table A-2](#):

Table A-2 Variable Names for Log Event Watch Rule Expressions

Variable	Description	Data Type
CONTEXTID	The request ID propagated with the request.	String
DATE	Date when the message was created.	String
MACHINE	Name of machine that generated the log message.	String
MESSAGE	Message content of the log message.	String
MSGID	ID of the log message (usually starts with "BEA=").	String
RECORDID	The number of the record in the log.	Long
SERVER	Name of server that generated the log message.	String
SEVERITY	Severity of log message. Values are ALERT, CRITICAL, DEBUG, EMERGENCY, ERROR, INFO, NOTICE, OFF, TRACE, and WARNING.	String
SUBSYSTEM	Name of subsystem emitting the log message.	String
THREAD	Name of thread that generated the log message.	String
TIMESTAMP	Timestamp when the log message was created.	Long
TXID	JTA transaction ID of thread that generated the log message.	String
USERID	ID of the user that generated the log message.	String

An example log event watch rule expression is:

```
(SEVERITY = 'Warning') AND (MSGID = 'BEA-320012')
```

Creating Instrumentation Event Watch Rule Expressions

An *instrumentation event* watch rule expression is based upon attributes of a data record created by a diagnostic monitor action.

Variable names for instrumentation data record attributes are listed and explained in [Table A-3](#):

Table A-3 Variable Names for Instrumentation Event Rule Expressions

Variable	Description	Data Type
ARGUMENTS	Arguments passed to the method that was invoked.	String
CLASSNAME	Class name of joinpoint.	String
CONTEXTID	Diagnostic context ID of instrumentation event.	String
CTXPAYLOAD	The context payload associated with this request.	String
DOMAIN	Name of domain.	String
DYES	Dyes associated with this request.	Long
FILENAME	Source file name.	String
LINENUM	Line number in source file.	Integer
METHODNAME	Method name of joinpoint.	String
METHODDSC	Method arguments of joinpoint.	String
MODULE	Name of the diagnostic module.	String
MONITOR	Name of the monitor.	String
PAYLOAD	Payload of instrumentation event.	String
RECORDID	The number of the record in the log.	Long
RETVAL	Return value of joinpoint.	String
SCOPE	Name of instrumentation scope.	String
SERVER	Name of server that created the instrumentation event.	String
TIMESTAMP	Timestamp when the instrumentation event was created.	Long

Table A-3 Variable Names for Instrumentation Event Rule Expressions (Continued)

Variable	Description	Data Type
TXID	JTA transaction ID of thread that created the instrumentation event.	String
TYPE	Type of monitor.	String
USERID	ID of the user that created the instrumentation event.	String

An example instrumentation event data rule expression is:

```
(USERID = 'weblogic')
```

Creating Harvester Watch Rule Expressions

A *harvester* watch rule expression is based upon one or more harvestable MBean attributes. The expression can specify an MBean type, an instance, and/or an attribute.

Instance-based and type-based expressions can contain an optional *namespace* component, which is the namespace of the metric being watched. It can be set to either `Server Runtime` or `DomainRuntime`. If omitted, it defaults to `ServerRuntime`.

If included and set to `DomainRuntime`, you should limit the usage to monitoring only `DomainRuntime`-specific MBeans, such as the `ServerLifecycleRuntimeMBean`. Monitoring remote managed server MBeans through the `DomainRuntime` MBeanServer is possible, but is discouraged for performance reasons. It is a best practice to use the resident watcher in each managed server to monitor metrics related to that managed server instance.

You can also use wildcards in instance names in Harvester watch rule expressions, as well as specify complex attributes in Harvester watch rule expressions. See [Appendix C, “Using Wildcards in Expressions.”](#)

The syntax for constructing a Harvester watch rule expression is as follows:

- To specify an attribute of all instances of a type, use the following syntax:

```
`${namespace}//[type_name]//attribute_name`
```

- To specify an attribute of an instance of a WebLogic type, use the following syntax:

```
`${com.bea:namespace}//instance_name//attribute_name`
```

- To specify an attribute of an instance of a custom MBean type, use the following syntax:

```
_${domain_name}:instance_name//attribute_name}
```

Note: The *domain_name* is not required for a WebLogic Server domain name.

The expression must include the complete MBean object name, as shown in the following example:

```
_${com.bea:Name=HarvesterRuntime,Location=myserver,Type=HarvesterRuntime,
  ServerRuntime=myserver//TotalSamplingCycles} > 10
```

Creating Data Accessor Queries

Use the WLDF query language with the Data Accessor component to retrieve data from data stores, including server logs, HTTP logs, and harvested metrics. The variables used to build a Data Accessor query are based on the column names in the data store from which you want to extract data.

A Data Accessor query contains the following:

- The logical name of a data store, as described in [“Data Store Logical Names” on page A-9](#).
- Optionally, the name(s) of one or more columns from which to retrieve data, as described in [“Data Store Column Names” on page A-11](#).

When there is a match, all columns of matching rows are returned.

Data Store Logical Names

The logical name for a data store must be unique. It denotes a specific data store available on the server. The logical name consists of a log type keyword followed by zero or more identifiers separated by the forward-slash (/) delimiter. For example, the logical name of the server log data

store is simply `ServerLog`. However, other log types may require additional identifiers, as shown in [Table A-4](#).

Table A-4 Naming Conventions for Log Types

Log Type	Optional Identifiers	Example
ConnectorLog	The JNDI name of the connection factory	ConnectorLog/eis/ 900eisaBlackBoxXATxConnectorJNDINAME where eis/900eisaBlackBoxXATxConnectorJNDINAME is the JNDI name of the connection factory specified in the <code>weblogic-ra.xml</code> deployment descriptor.
DomainLog	None	DomainLog
EventsDataArchive	None	EventsDataArchive
HarvestedDataArchive	None	HarvestedDataArchive
HTTPAccessLog	Virtual host name	HTTPAccessLog - For the default web server's access log. HTTPAccessLog/MyVirtualHost - For the Virtual host named MyVirtualHost deployed to the current server. Note: In the case of HTTPAccessLog logs with extended format, the number of columns are user-defined.
JMSMessageLog	The name of the JMS Server.	JMSMessageLog/MyJMSServer
ServerLog	None	ServerLog
WebAppLog	Web server name + Root servlet context name	WebAppLog/MyWebServer/MyRootServletContext

Data Store Column Names

The column names included in a query are resolved for each row of data. A row is added to the result set only if it satisfies the query conditions for all specified columns. A query that omits column names returns all the entries in the log.

All column names from all WebLogic Server log types are listed in [Table A-5](#).

Table A-5 Column Names for Log Types

Log Type	Column Names
ConnectorLog	LINE, RECORDID
DomainLog	CONTEXTID, DATE, MACHINE, MESSAGE, MSGID, RECORDID, SERVER, SEVERITY, SUBSYSTEM, THREAD, TIMESTAMP, TXID, USERID
EventsDataArchive	ARGUMENTS, CLASSNAME, CONTEXTID, CTXPAYLOAD, DOMAIN, DYES, FILENAME, LINENUM, METHODNAME, METHODDSC, MODULE, MONITOR, PAYLOAD, RECORDID, RETVAL, SCOPE, SERVER, THREADNAME, TIMESTAMP, TXID, TYPE, USERID
HarvestedDataArchive	ATTRNAME, ATTRTYPE, ATTRVALUE, DOMAIN, NAME, RECORDID, SERVER, TIMESTAMP, TYPE
HTTPAccessLog	AUTHUSER, BYTECOUNT, HOST, RECORDID, REMOTEUSER, REQUEST, STATUS, TIMESTAMP
JDBCLog	Same as DomainLog
JMSMessageLog	CONTEXTID, DATE, DESTINATION, EVENT, JMSCORRELATIONID, JMSMESSAGEID, MESSAGE, MESSAGECONSUMER, NANOTIMESTAMP, RECORDID, SELECTOR, TIMESTAMP, TXID, USERID
ServerLog	Same as DomainLog
WebAppLog	Same as DomainLog

An example of a Data Accessor query is:

```
(SUBSYSTEM = 'Deployer') AND (MESSAGE LIKE '%Failed%')
```

In this example, the Accessor retrieves all messages that include the string “Failed” from the Deployer subsystem.

The following example shows an API method invocation. It includes a query for harvested attributes of the JDBC connection pool named `MyPool`, within an interval between a `timeStampFrom` (inclusive) and a `timeStampTo` (exclusive):

```
WLDFDataAccessRuntimeMBean.retrieveDataRecords(timeStampFrom,  
        timeStampTo, "TYPE='JDBCConnectionPoolRuntime' AND NAME='MyPool'")
```

For complete documentation about the WLDF Data Accessor, see [Chapter 12, “Accessing Diagnostic Data With the Data Accessor.”](#)

Creating Log Filter Expressions

The query language can be used to filter what is written to the server log. The variables used to construct a log filter expression represent the columns in the log:

- CONTEXTID
- DATE
- MACHINE
- MESSAGE
- MSGID
- RECORDID
- SEVERITY
- SUBSYSTEM
- SERVER
- THREAD
- TIMESTAMP
- TXID
- USERID

Note: These are the same variables that you use to build a Data Accessor query for retrieving historical diagnostic data from existing server logs.

For complete documentation about the WebLogic Server logging services, see [“Filtering WebLogic Server Log Messages”](#) in *Configuring Log Files and Filtering Log Messages*.

Building Complex Expressions

You can build complex query expressions using sub-expressions containing variables, binary comparisons, and other complex sub-expressions. There is no limit on levels of nesting. The following rules apply:

- Nest queries by surrounding sub-expressions within parentheses, for example:

```
(SEVERITY = 'Warning') AND (MSGID = 'BEA-320012')
```

- Enclose a variable name within `{ }` if it includes special characters, as in an MBean object name. For example:

```
#{mydomain:Name=myserver,  
  Type=ServerRuntime//SocketsOpenedTotalCount} >= 1
```

Notice that the object name and the attribute name are separated by `//` in the watch variable name.

WLDF Query Language

WLDF Instrumentation Library

The WebLogic Diagnostic Framework Instrumentation Library contains diagnostic monitors and diagnostic actions, as discussed in the following sections:

- [“Diagnostic Monitor Library” on page B-1](#)
- [“Diagnostic Action Library” on page B-14](#)

For information about using items from the Instrumentation Library, see [Chapter 10, “Configuring Instrumentation.”](#)

Diagnostic Monitor Library

Diagnostic monitors are broadly classified as server-scoped and application-scoped monitors. The former can be used to instrument WebLogic Server classes. You use the latter to instrument application classes. Except for the `DyeInjection` monitor, all monitors are delegating monitors, that is, they do not have a built-in diagnostic action. Instead, they delegate to actions attached to them to perform diagnostic activity.

All monitors are preconfigured with their respective pointcuts. However, the actual locations affected by them may vary depending on the classes they instrument. For example, the `Servlet_Before_Service` monitor adds diagnostic code at the entry of servlet or java server page (JSP) service methods at different locations in different servlet implementations.

For any delegating monitor, only compatible actions may be attached. The compatibility is determined by the nature of the monitor.

The following table lists and describes the diagnostic monitors that can be used within server scope, that is, in WebLogic Server classes. For the diagnostic actions that are compatible with each monitor, see the **Compatible Action Type** column in the table.

Table B-1 Diagnostic Monitors for Use Within Server Scope

Monitor Name	Monitor Type	Compatible Action Type	Pointcuts
Connector_Before_Inbound	Before	Stateless	At entry of methods handling inbound connections.
Connector_After_Inbound	Server	Stateless	At exit of methods handling inbound connections.
Connector_Around_Inbound	Around	Around	At entry and exit of methods handling inbound connections.
Connector_Before_Outbound	Before	Stateless	At entry of methods handling outbound connections.
Connector_After_Outbound	After	Stateless	At exit of methods handling outbound connections.
Connector_Around_Outbound	Around	Around	At entry and exit of methods handling outbound connections.
Connector_Before_Tx	Before	Stateless	Entry of transaction register, unregister, start, rollback and commit methods.
Connector_After_Tx	After	Stateless	At exit of transaction register, unregister, start, rollback and commit methods.
Connector_Around_Tx	Around	Around	At entry and exit of transaction register, unregister, start, rollback and commit methods.
Connector_Before_Work	Before	Stateless	At entry of methods related to scheduling, starting and executing connector work items.
Connector_After_Work	After	Stateless	At exit of methods related to scheduling, starting and executing connector work items.

Table B-1 Diagnostic Monitors for Use Within Server Scope (Continued)

Monitor Name	Monitor Type	Compatible Action Type	Pointcuts
Connector_Around_Work	Around	Around	At entry and exit of methods related to scheduling, starting and executing connector work items.
DyeInjection	Before	Built-in	At points where requests enter the server.
JDBC_Before_Commit_Internal	Before	Stateless	JDBC subsystem internal code
JDBC_After_Commit_Internal	After	Stateless	JDBC subsystem internal code
JDBC_Before_Connection_Internal	Before	Stateless	Before calls to methods: Driver.connect DataSource.getConnection
JDBC_After_Connection_Internal	Before	Stateless	JDBC subsystem internal code
JDBC_Before_Rollback_Internal	Before	Stateless	JDBC subsystem internal code
JDBC_After_Rollback_Internal	After	Stateless	JDBC subsystem internal code
JDBC_Before_Start_Internal	Before	Stateless	JDBC subsystem internal code
JDBC_After_Start_Internal	After	Stateless	JDBC subsystem internal code
JDBC_Before_Statement_Internal	Before	Stateless	JDBC subsystem internal code
JDBC_After_Statement_Internal	After	Stateless	JDBC subsystem internal code

[Table B-2](#) lists the diagnostic monitors that can be used within application scopes, that is, in deployed applications. For the diagnostic actions that are compatible with each monitor, see the **Compatible Action Type** column in the table.

Table B-2 Diagnostic Monitors for Use Within Application Scopes

Monitor Name	Monitor Type	Compatible Action Type	Pointcuts
EJB_After_EntityEjbBusiness Methods	After	Stateless	At exits of all <code>EntityBean</code> methods, which are not standard <code>ejb</code> methods.
EJB_Around_EntityEjbBusiness Methods	Around	Around	At entry and exits of all <code>EntityBean</code> methods that are not standard <code>ejb</code> methods.
EJB_After_EntityEjbMethods	After	Stateless	At exits of methods: <code>EntityBean.setEntityContext</code> <code>EntityBean.unsetEntityContext</code> <code>EntityBean.ejbRemove</code> <code>EntityBean.ejbActivate</code> <code>EntityBean.ejbPassivate</code> <code>EntityBean.ejbLoad</code> <code>EntityBean.ejbStore</code>
EJB_Around_EntityEjbMethods	Around	Around	At exits of methods: <code>EntityBean.setEntityContext</code> <code>EntityBean.unsetEntityContext</code> <code>EntityBean.ejbRemove</code> <code>EntityBean.ejbActivate</code> <code>EntityBean.ejbPassivate</code> <code>EntityBean.ejbLoad</code> <code>EntityBean.ejbStore</code>
EJB_After_EntityEjbSemantic Methods	After	Stateless	At exits of methods: <code>EntityBean.set*</code> <code>EntityBean.get*</code> <code>EntityBean.ejbFind*</code> <code>EntityBean.ejbHome*</code> <code>EntityBean.ejbSelect*</code> <code>EntityBean.ejbCreate*</code> <code>EntityBean.ejbPostCreate*</code>

Table B-2 Diagnostic Monitors for Use Within Application Scopes (Continued)

Monitor Name	Monitor Type	Compatible Action Type	Pointcuts
EJB_Around_EntityEjbSemanticMethods	Around	Around	At entry and exits of methods: EntityBean.set* EntityBean.get* EntityBean.ejbFind* EntityBean.ejbHome* EntityBean.ejbSelect* EntityBean.ejbCreate* EntityBean.ejbPostCreate*
EJB_After_SessionEjbMethods	After	Stateless	At exits of methods: SessionBean.setSessionContext SessionBean.ejbRemove SessionBean.ejbActivate SessionBean.ejbPassivate
EJB_Around_SessionEjbMethods	Around	Around	At entry and exits of methods: SessionBean.setSessionContext SessionBean.ejbRemove SessionBean.ejbActivate SessionBean.ejbPassivate
EJB_After_SessionEjbBusinessMethods	After	Stateless	At exits of all SessionBean methods, which are not standard ejb methods.
EJB_Around_SessionEjbBusinessMethods	Around	Around	At entry and exits of all SessionBean methods, which are not standard ejb methods.
EJB_After_SessionEjbSemanticMethods	After	Stateless	At exits of methods: SessionBean.ejbCreateSessionBean. SessionBean.ejbPostCreate
EJB_Around_SessionEjbSemanticMethods	Around	Around	At entry and exits of methods: SessionBean.ejbCreate SessionBean.ejbPostCreate
EJB_Before_EntityEjbBusinessMethods	Before	Stateless	At entry of all EntityBean methods, which are not standard ejb methods.

Table B-2 Diagnostic Monitors for Use Within Application Scopes (Continued)

Monitor Name	Monitor Type	Compatible Action Type	Pointcuts
EJB_Before_EntityEjbMethods	Before	Stateless	At entry of methods: EnitityBean.setEntityContext EnitityBean.unsetEntityContext EnitityBean.ejbRemove EnitityBean.ejbActivate EnitityBean.ejbPassivate EnitityBean.ejbLoad EnitityBean.ejbStore
EJB_Before_EntityEjbSemantic Methods	Before	Stateless	At entry of methods: EnitityBean.set* EnitityBean.get* EnitityBean.ejbFind* EnitityBean.ejbHome* EnitityBean.ejbSelect* EnitityBean.ejbCreate* EnitityBean.ejbPostCreate*
EJB_Before_SessionEjb BusinessMethods	Before	Stateless	At entry of all SessionBean methods, which are not standard ejb methods.
EJB_Before_SessionEjbMethods	Before	Stateless	At entry of methods: SessionBean.setSessionContext SessionBean.ejbRemove SessionBean.ejbActivate SessionBean.ejbPassivate
EJB_Before_SessionEjb SemanticMethods	Before	Stateless	At entry of methods: SessionBean.ejbCreate SessionBean.ejbPostCreate

Table B-2 Diagnostic Monitors for Use Within Application Scopes (Continued)

Monitor Name	Monitor Type	Compatible Action Type	Pointcuts
HttpSessionDebug	Around	Built-in	getSession - Inspects returned HTTP session Before and after calls to methods: getAttribute setAttribute removeAttribute At inspection points, the approximate session size is computed and stored as the payload of a generated event. The size is computed by flattening the session to a byte-array. If an error is encountered while flattening the session, a negative size is reported.
JDBC_Before_CloseConnection	Before	Stateless	Before calls to methods: Connection.close
JDBC_After_CloseConnection	After	Stateless	After calls to methods: Connection.close
JDBC_Around_CloseConnection	Around	Around	Before and after calls to methods: Connection.close
JDBC_Before_CommitRollback	Before	Stateless	Before calls to methods: Connection.commit Connection.rollback
JDBC_After_CommitRollback	After	Stateless	After calls to methods: Connection.commit Connection.rollback
JDBC_Around_CommitRollback	Around	Around	Before and after calls to methods: Connection.commit Connection.rollback

Table B-2 Diagnostic Monitors for Use Within Application Scopes (Continued)

Monitor Name	Monitor Type	Compatible Action Type	Pointcuts
JDBC_Before_Execute	Before	Stateless	Before calls to methods: Statement.execute* PreparedStatement.execute*
JDBC_After_Execute	After	Stateless	After calls to methods: Statement.execute* PreparedStatement.execute*
JDBC_Around_Execute	Around	Around	Before and after calls to methods: Statement.execute* PreparedStatement.execute*
JDBC_Before_GetConnection	Before	Stateless	Before calls to methods: Driver.connect DataSource.getConnection
JDBC_After_GetConnection	After	Stateless	After calls to methods: Driver.connect DataSource.getConnection
JDBC_Around_GetConnection	Around	Around	Before and after calls to methods: Driver.connect DataSource.getConnection
JDBC_Before_Statement	Before	Stateless	Before calls to methods: Connection.prepareStatement Connection.prepareCall Statement.addBatch ResultSet.setCommand
JDBC_After_Statement	After	Stateless	After calls to methods: Connection.prepareStatement Connection.prepareCall Statement.addBatch ResultSet.setCommand

Table B-2 Diagnostic Monitors for Use Within Application Scopes (Continued)

Monitor Name	Monitor Type	Compatible Action Type	Pointcuts
JDBC_Around_Statement	Around	Around	Before and after calls to methods: <code>Connection.prepareStatement</code> <code>Connection.prepareCall</code> <code>Statement.addBatch</code> <code>RowSet.setCommand</code>
JMS_Before_AsyncMessageReceived	Before	Stateless	At entry of methods: <code>MessageListener.onMessage</code>
JMS_After_AsyncMessageReceived	After	Stateless	At exits of methods: <code>MessageListener.onMessage</code>
JMS_Around_AsyncMessageReceived	Around	Around	At entry and exits of methods: <code>MessageListener.onMessage</code>
JMS_Before_MessageSent	Before	Stateless	Before call to methods: <code>QueueSender.send</code>
JMS_After_MessageSent	After	Stateless	After call to methods: <code>QueueSender.send</code>
JMS_Around_MessageSent	Around	Around	Before and after call to methods: <code>QueueSender.send</code>
JMS_Before_SyncMessageReceived	Before	Stateless	Before calls to methods: <code>MessageConsumer.receive*</code>
JMS_After_SyncMessageReceived	After	Stateless	After calls to methods: <code>MessageConsumer.receive*</code>
JMS_Around_SyncMessageReceived	Around	Around	Before and after calls to methods: <code>MessageConsumer.receive*</code>
JMS_Before_TopicPublished	Before	Stateless	Before call to methods: <code>TopicPublisher.publish</code>

Table B-2 Diagnostic Monitors for Use Within Application Scopes (Continued)

Monitor Name	Monitor Type	Compatible Action Type	Pointcuts
JMS_After_TopicPublished	After	Stateless	After call to methods: TopicPublisher.publish
JMS_Around_TopicPublished	Around	Around	Before and after call to methods: TopicPublisher.publish
JNDI_Before_Lookup	Before	Stateless	Before calls to javax.naming.Context lookup methods Context.lookup*
JNDI_After_Lookup	After	Stateless	After calls to javax.naming.Context lookup methods: Context.lookup*
JNDI_Around_Lookup	Around	Around	Before and after calls to javax.naming.Context lookup methods Context.lookup*
JTA_Before_Commit	Before	Stateless	At entry of methods: UserTransaction.commit
JTA_After_Commit	After	Stateless advice	At exits of methods: UserTransaction.commit
JTA_Around_Commit	Around	Around	At entry and exits of methods: UserTransaction.commit
JTA_Before_Rollback	Before	Stateless	At entry of methods: UserTransaction.rollback
JTA_After_Rollback	After	Stateless advice	At exits of methods: UserTransaction.rollback
JTA_Around_Rollback	Around	Around	At entry and exits of methods: UserTransaction.rollback

Table B-2 Diagnostic Monitors for Use Within Application Scopes (Continued)

Monitor Name	Monitor Type	Compatible Action Type	Pointcuts
JTA_Before_Start	Before	Stateless	At entry of methods: UserTransaction.begin
JTA_After_Start	After	Stateless advice	At exits of methods: UserTransaction.begin
JTA_Around_Start	Around	Around	At entry and exits of methods: UserTransaction.begin
MDB_Before_MessageReceived	Before	Stateless	At entry of methods: MessageDrivenBean.onMessage
MDB_After_MessageReceived	After	Stateless	At exits of methods: MessageDrivenBean.onMessage
MDB_Around_MessageReceived	Around	Around	At entry and exits of methods: MessageDrivenBean.onMessage
MDB_Before_Remove	Before	Stateless	At entry of methods: MessageDrivenBean.ejbRemove
MDB_After_Remove	After	Stateless	At exits of methods: MessageDrivenBean.ejbRemove
MDB_Around_Remove	Around	Around	At entry and exits of methods: MessageDrivenBean.ejbRemove
MDB_Before_SetMessageDrivenContext	Before	Stateless	At entry of methods: MessageDrivenBean.setMessageDrivenContext
MDB_After_SetMessageDrivenContext	After	Stateless	At exits of methods: MessageDrivenBean.setMessageDrivenContext

Table B-2 Diagnostic Monitors for Use Within Application Scopes (Continued)

Monitor Name	Monitor Type	Compatible Action Type	Pointcuts
MDB_Around_SetMessageDrivenContext	Around	Around	At entry and exits of methods: MessageDrivenBean.setMessageDrivenContext
Servlet_Before_Service	Before	Stateless	At method entries of servlet/jsp methods: HttpJspPage._jspService Servlet.service HttpServlet.doGet HttpServlet.doPost Filter.doFilter
Servlet_After_Service	After	Stateless	At method exits of servlet/jsp methods: HttpJspPage._jspService Servlet.service HttpServlet.doGet HttpServlet.doPost Filter.doFilter
Servlet_Around_Service	Around	Around	At method entry and exits of servlet/jsp methods: HttpJspPage._jspService Servlet.service HttpServlet.doGet HttpServlet.doPost Filter.doFilter
Servlet_Before_Session	Before	Stateless	Before calls to servlet methods: HttpServletRequest.getSession HttpSession.setAttribute/ putValue HttpSession.getAttribute/ getValue HttpSession.removeAttribute/ removeValue HttpSession.invalidate

Table B-2 Diagnostic Monitors for Use Within Application Scopes (Continued)

Monitor Name	Monitor Type	Compatible Action Type	Pointcuts
<code>Servlet_Around_Session</code>	Around	Around	Before and after calls to servlet methods: <code>HttpServletRequest.getSession</code> <code>HttpSession.setAttribute/ putValue</code> <code>HttpSession.getAttribute/ getValue</code> <code>HttpSession.removeAttribute/ removeValue</code> <code>HttpSession.invalidate</code>
<code>Servlet_After_Session</code>	After	Stateless	After calls to servlet methods: <code>HttpServletRequest.getSession</code> <code>HttpSession.setAttribute/ putValue</code> <code>HttpSession.getAttribute/ getValue</code> <code>HttpSession.removeAttribute/ removeValue</code> <code>HttpSession.invalidate</code>
<code>Servlet_Before_Tags</code>	Before	Stateless	Before calls to jsp methods: <code>Tag.doStartTag</code> <code>Tag.doEndTag</code>
<code>Servlet_After_Tags</code>	After	Stateless	After calls to jsp methods: <code>Tag.doStartTag</code> <code>Tag.doEndTag</code>
<code>Servlet_Around_Tags</code>	Around	Around	Before and after calls to jsp methods: <code>Tag.doStartTag</code> <code>Tag.doEndTag</code>

Diagnostic Action Library

The Diagnostic Action Library includes the following actions:

- [TraceAction](#)
- [DisplayArgumentsAction](#)
- [TraceElapsedTimeAction](#)
- [StackDumpAction](#)
- [ThreadDumpAction](#)
- [MethodInvocationStatisticsAction](#)

These diagnostic actions can be used with the delegating monitors described in the previous tables. They can also be used with custom monitors that you can define and use within applications. Each diagnostic action can only be used with monitors with which they are compatible, as indicated by the Compatible Monitor Type column. Some actions (for example, `TraceElapsedTimeAction`) generate an event payload.

TraceAction

This action is a stateless action and is compatible with Before and After monitor types.

A `TraceAction` generates a trace event at the affected location in the program execution. The following information is generated:

- Timestamp
- Context identifier from the diagnostic context which uniquely identifies the request
- Transaction identifier, if available
- User identity
- Action type, that is, `TraceAction`
- Domain
- Server name
- Instrumentation scope name (for example, application name)
- Diagnostic monitor name
- Location in code from where the action was called (class name, method name, etc.)

- Payload carried by the diagnostic context, if any

DisplayArgumentsAction

This action is a stateless action and is compatible with Before and After monitor types.

A `DisplayArgumentsAction` generates an instrumentation event at the affected location in the program execution to capture method arguments or a return value.

When executed, this action causes an instrumentation event that is dispatched to the events archive. When attached to *before* monitors, the instrumentation event captures input arguments to the joinpoint (for example, method arguments). When attached to *after* monitors, the instrumentation event captures the return value from the joinpoint. The event carries the following information:

- Timestamp
- Context identifier from the diagnostic context that uniquely identifies the request
- Transaction identifier, if available
- User identity
- Action type, that is, `DisplayArgumentsAction`
- Domain
- Server name
- Instrumentation scope name (for example, application name)
- Diagnostic monitor name
- Location in code from where the action was called (class name, method name, etc.)
- Payload carried by the diagnostic context, if any
- Input arguments, if any, when attached to *before* monitors
- Return value, if any, when attached to *after* monitors

TraceElapsedTimeAction

This action is an Around action and is compatible with Around monitor types.

A `TraceElapsedTimeAction` generates two events: one before and one after the location in the program execution.

When executed, this action captures the timestamps before and after the execution of an associated joinpoint. It then computes the elapsed time by computing the difference. It generates an instrumentation event which is dispatched to the events archive. The elapsed time is stored as event payload. The event carries the following information:

- Timestamp
- Context identifier from the diagnostic context that uniquely identifies the request
- Transaction identifier, if available
- User identity
- Action type, that is, `TraceElapsedTimeAction`
- Domain
- Server name
- Instrumentation scope name (for example, application name)
- Diagnostic monitor name
- Location in code from where the action was called (class name, method name, etc.)
- Payload carried by the diagnostic context, if any
- Elapsed time processing the joinpoint, as event payload, in nanoseconds

StackDumpAction

This action is a stateless action and is compatible with Before and After monitor types.

A `StackDumpAction` generates an instrumentation event at the affected location in the program execution to capture a stack dump.

When executed, this action generates an instrumentation event which is dispatched to the events archive. It captures the stack trace as an event payload. The event carries following information:

- Timestamp

- Context identifier from the diagnostic context that uniquely identifies the request
- Transaction identifier, if available
- User identity
- Action type, that is, `StackDumpAction`
- Domain
- Server name
- Instrumentation scope name (for example, application name)
- Diagnostic monitor name
- Location in code from where the action was called (class name, method name, etc.)
- Payload carried by the diagnostic context, if any
- Stack trace as an event payload

ThreadDumpAction

This action is a stateless action and is compatible with Before and After monitor types.

A `ThreadDumpAction` generates an instrumentation event at the affected location in the program execution to capture a thread dump, if the underlying VM supports it. JDK 1.5 (Oracle JRockit and Sun) supports this action.

This action generates an instrumentation event which is dispatched to the events archive. This action may be used only with the JRockit JVM. It is ignored when used with other JVMs. It captures the thread dump as event payload. The event carries the following information:

- Timestamp
- Context identifier from the diagnostic context that uniquely identifies the request
- Transaction identifier, if available
- User identity
- Action type, that is, `ThreadDumpAction`
- Domain
- Server name

- Instrumentation scope name (for example, application name)
- Diagnostic monitor name
- Location in code from where the action was called (class name, method name, etc.)
- Payload carried by the diagnostic context, if any
- Thread dump as an event payload

MethodInvocationStatisticsAction

This action is an Around action and is compatible with Around monitor types.

A `MethodInvocationStatisticsAction` computes method invocation statistics in memory without persisting an event for each invocation. It makes the collected information available through the `InstrumentationRuntimeMBean`. The collected information is consumable by the Harvester and the Watch-Notifications components. This makes it possible to create watch rules that can combine request information from the instrumentation system and metric information from other runtime MBeans.

The `WLDFInstrumentationRuntimeMBean` instance for a given scope exposes the data collected from the `MethodInvocationStatisticsAction` instances attached to the configured Diagnostic Around monitors, using the `MethodInvocationStatistics` attribute. This attribute returns a map with a nested structure that has the following semantics:

```
MethodInvocationStatistics ::= Map<className, MethodMap>
MethodMap ::= Map<methodName, MethodParamsSignatureMap>
MethodParamsSignatureMap ::= Map<MethodParamsSignature, MethodDataMap>
MethodDataMap ::= <MetricName, Statistic>
MetricName ::= min | max | avg | count | sum | sum_of_squares | std_deviation
```

The first level of entries is keyed by the fully qualified class names. The next level yields a map called `MethodMap`, whose keys are method names and values of another nested map structure, `MethodParamsSignatureMap`. `MethodParamsSignatureMap` contains entries that are keyed by a String representation of the method input argument signature to return another map instance, `MethodDataMap`. `MethodDataMap` has a fixed set of keys for the names of the different kinds of supported metrics.

Configuring the Harvester to Collect MethodInvocationStatisticsAction Data

To configure the Harvester to collect data gathered by the MethodInvocationStatisticsAction instances, you have to configure an instance of WLDHHarvesterBean with:

```
Name=weblogic.management.runtime.WLDHInstrumentationRuntimeMBean
```

The scope is selected by the instance configuration.

The attribute specification defines the data that is collected by the Harvester. The successive elements of the map are accessed by using the following notation:

```
MethodInvocationStatistics(className)(methodName)(methodParamSignature)
(metricName)
```

<code>className</code>	The fully qualified Java class name. You can use the '*' wildcard in a class name.
<code>methodName</code>	Selects a specific method from the given class. You can use the '*' wildcard in a method name.
<code>methodParamSignature</code>	<p>A string that is a comma-separated list of a method's input argument types. Only the Java type names are included in the signature specification without the argument names. As in the Java language, the order of the parameters in the signature is significant.</p> <p>This element also supports the '*' wildcard, so you do not have to specify the entire list of input argument types for a method. '*' matches zero or more argument types at the position following its occurrence in the methodParamSignature expression.</p> <p>You can also use the '?' wildcard to match a single argument type at any given position in the ordered list of parameter types.</p> <p>Both of these wildcards can appear anywhere in the expression. See "MethodInvocationStatistics Examples."</p>
<code>metricName</code>	The statistics to harvest. You can use the '*' wildcard in this key to harvest all of the supported metrics.

MethodInvocationStatistics Examples

Consider a class with the following overloaded methods:

```
package.com.foo;  
  
public interface Bar {  
    public void doIt();  
    public void doIt(int a);  
    public void doIt(int a, String s);  
    public void doIt(String a, int b);  
    public void doIt(String a, String b);  
    public void doIt(String[] a);  
    public void doNothing();  
    public void doNothing(com.foo.Baz);  
}
```

The following examples show how to use harvest various statistics:

```
MethodInvocationStatistics(com.foo.Bar)(*)(*)(*)  
    Harvests all statistics for all methods in the com.foo.Bar class.
```

```
MethodInvocationStatistics(com.foo.Bar)(doIt())(*)  
    Harvests all statistics for the doIt() method that has no input arguments.
```

```
MethodInvocationStatistics(com.foo.Bar)(doIt)(*)(*)  
    Harvests all statistics for all doIt() methods.
```

```
MethodInvocationStatistics(com.foo.Bar)(doIt)(int,*)(*)  
    Harvests all statistics for the doIt(int) and doIt(int, String) methods.
```

```
MethodInvocationStatistics(com.foo.Bar)(doIt)(String[])(*)  
    Harvests all statistics for the doIt(String[]) method. Array parameters use the [] pair following the type name. Spaces are insignificant for the Harvester.
```

```
MethodInvocationStatistics(com.foo.Bar)(doIt)(String, ?)(*)
```

Harvest all statistics for the `doIt` methods with two input parameters and `String` as the first argument type. Using the example class, this would match the `doIt(String, int)` and `doIt(String, String)` methods.

```
MethodInvocationStatistics(com.foo.Bar)(doNothing)(com.foo.Baz)(min|max)
```

Harvest the `min` and `max` execution time for the `doNothing()` method with the single input parameter of type `com.foo.Baz`.

Note: Using a wildcard in the `className` can impact performance.

Configuring Watch Rules Based on MethodInvocationStatistics Metrics

You can use the same syntax described in the previous sections to use `MethodInvocationStatistics` metrics in a watch rule. You can create meaningful watch rules that do not wildcard the `MetricName` element, and instead specify whether you are interested in the `min`, `max`, `avg`, `count`, `sum`, `sum_of_squares`, or `std_deviation` variable for a given method.

Using JMX to Collect Data

When using straight JMX to collect data, you can potentially impact server performance if you invoke the `getAttribute("MethodInvocationStatistics")` method on the `WLDFInstrumentationRuntimeMBean`. This is because, depending on the instrumented classes, the nested map structure can contain a lot of data that will involve expensive serialization.

It is more advisable to use the `getMethodInvocationStatisticsData(String)` method when using JMX to collect data.

Using Wildcards in Expressions

WLDF allows for the use of wildcards in instance names within the `<harvested-instance>` element, and also provides drill-down and wildcard capabilities in the attribute specification of the `<harvested-attribute>` element.

WLDF also allows the same wildcard capabilities for instance names in Harvester watch rules, as well as specifying complex attributes in Harvester watch rules.

These capabilities are discussed in the following sections:

- [“Using Wildcards in Harvester Instance Names” on page C-1](#)
- [“Specifying Complex and Nested Harvester Attributes” on page C-3](#)
- [“Using the Accessor with Harvested Complex or Nested Attributes” on page C-6](#)
- [“Using Wildcards in Watch Rule Instance Names” on page C-7](#)
- [“Specifying Complex Attributes in Harvester Watch Rules” on page C-7](#)

Using Wildcards in Harvester Instance Names

When specifying instance names within the `<harvested-instance>` element, you can:

- express the instance name in non-canonical form, allowing you to specify the property list of the `ObjectName` out of order
- express the `ObjectName` as a JMX `ObjectName` query pattern without concern as to the order of the property list.

- use zero or more '*' wildcards in any of the values in the property list of an ObjectName, such as Name=*
- use zero or more '*' wildcards to replace any character sequence in a canonical ObjectName string. In this case, you must ensure that any properties of the ObjectName that are not wildcarded are in canonical form.

Examples

The instance specification in [Listing C-1](#) indicates that all instances of the WorkManagerRuntimeMBean are to be harvested. This is equivalent to not providing an instance-name qualification at all in the <harvested-type> declaration.

Listing C-1 Harvesting All Instances of an MBean

```
<harvested-type>
  <name>weblogic.management.runtime.WorkManagerRuntimeMBean</name>
  <harvested-instance>*</harvested-instance>
  <known-type>true</known-type>
  <harvested-attribute>PendingRequests</harvested-attribute>
</harvested-type>
```

The example in [Listing C-2](#) shows a JMX ObjectName pattern as the <harvested-instance> value:

Listing C-2 Using a JMX ObjectName Pattern

```
<harvested-type>
  <name>com.acme.CustomMBean</name>
  <harvested-instance>adomain:Type=MyType,*</harvested-instance>
  <known-type>false</known-type>
</harvested-type>
```

In the example shown in [Listing C-3](#), some of the values in the ObjectName property list contain wildcards:

Listing C-3 Using Wildcards in the Property List

```
<harvested-type>
  <name>com.acme.CustomMBean</name>
  <harvested-instance>adomain:Type=My*,Name=*,*</harvested-instance>
  <known-type>false</known-type>
</harvested-type>
```

The example in [Listing C-4](#) indicates that all harvestable attributes of all instances of com.acme.CustomMBean are to be harvested, but only where the instance name contains the string “Name=mybean”.

Listing C-4 Harvesting All Attributes of Multiple Instances

```
<harvested-type>
  <name>coma.acme.CustomMBean</name>
  <harvested-instance>*Name=mybean*</harvested-instance>
  <known-type>true</known-type>
</harvested-type>
```

Specifying Complex and Nested Harvester Attributes

The Harvester provides the ability to access metric values nested within complex attributes of an MBean. A complex attribute can be a map or list object, a simple POJO, or different nestings of these types of objects. For example:

- anObject.anAttribute
- arrayAttribute[1]
- mapAttribute(akey)

Using Wildcards in Expressions

- `aList[1](aKey)`

In addition, wildcards can be used for list indexes and map keys to specify multiple elements within a collection of those types. The following wildcards are available:

- You can use `*` to specify all key values for Map attributes.
- You can use `%` to replace parts of a Map key string and identify a group of keys that match a particular pattern.

You can also specify a discrete set of key values by using a comma-separated list.

For example:

- `aList[1](partial%Key%)`
- `aList[*](key1,key3,keyN)`
- `aList*`

In the last example, where the `*` wildcard is used for the index to a list and as the key value to a nested map object, nested arrays of values are returned.

If you embed the `*` wildcard in a comma-separated list of map keys, such as:

```
aList[*](key1,*,keyN)
```

it is equivalent to specifying all map keys:

```
aList[*](*)
```

Notes: Leading or trailing spaces will be stripped from a map key unless the map key is enclosed within quotation marks.

Using a map key pattern can result in a large number of elements being scanned and/or returned. The larger the number of elements in a map, the bigger the impact there will be on performance.

The more complex the matching pattern is, the more processing time will be required.

Examples

To use drill-down syntax to harvest the nested `State` property of the `HealthState` attribute on the `ServerRuntime` MBean, you would use the following diagnostic descriptor:

Listing C-5 Using drill-down syntax

```
<harvester>
  <sample-period>10000</sample-period>
  <harvested-type>
    <name>weblogic.management.runtime.ServerRuntimeMBean</name>
    <harvested-attribute>HealthState.State</harvested-attribute>
  </harvested-type>
</harvester>
```

To harvest the elements of an array or list, the Harvester supports a subscript notation wherein a value is referred to by its index position in the array or list. For example, to refer to the first element in the array attribute `URLPatterns` in the `ServletRuntimeMBean`, specify `URLPatterns[0]`. If you want to reference all the elements of `URLPatterns` using a wildcard:

Listing C-6 Using a wildcard to reference all elements of an array

```
<harvester>
  <sample-period>10000</sample-period>
  <harvested-type>
    <name>weblogic.management.runtime.ServletRuntimeMBean</name>
    <harvested-attribute>URLPatterns[*]</harvested-attribute>
  </harvested-type>
</harvester>
```

To harvest the elements of a map, each individual value is referenced by the key enclosed in parentheses. Multiple keys can be specified as a comma-delimited list, in which case the values corresponding to specified keys in the map will be harvested.

The following code example harvests the value from the map with key `Foo`:

```
<harvested-attribute>MyMap(Foo)</harvested-attribute>
```

The next example harvests the value from the map with keys `Foo` and `Bar`:

```
<harvested-attribute>MyMap(Foo,Bar)</harvested-attribute>
```

The next example uses the `%` character with a key specification to harvest all values from the map if their keys start with `Foo` and end with `Bar`:

```
<harvested-attribute>MyMap(Foo%Bar)</harvested-attribute>
```

The next example harvests all values from a map by using the `*` character:

```
<harvested-attribute>MyMap(*)</harvested-attribute>
```

In the next example, the `MBean` has a `JavaBean` attribute `MyBean` which has a nested map type attribute `MyMap`. This code example harvests this value from the map whose key is `Foo`:

```
<harvested-attribute>MyBeanMyMap(Foo)</harvested-attribute>
```

Using the Accessor with Harvested Complex or Nested Attributes

While a large number of complex or nested attributes can be specified as a single expression in terms of the Harvester and Watch and Notifications configuration, the actual metrics are persisted in terms of each individually gathered metric.

For example, if the attribute specification:

```
mymap(*) . (a,b,c)
```

maps to the following actual nested attributes:

```
mymap(key1) . a  
mymap(key1) . b  
mymap(key1) . c  
mymap(key2) . a  
mymap(key2) . b  
mymap(key2) . c
```

then each of these six metrics are stored in a separate record in the `HarvestedDataArchive`, with the shown attribute names stored in the `ATTRNAME` column in each corresponding record. The values in the `ATTRNAME` column are the values you must use in Accessor queries when retrieving them from the archive.

Here are some example query strings:

```
NAME="foo:Name=MyMBean" ATTRNAME="mymap(key1).a"
```

```
NAME="foo"Name=MyMBean" ATTRNAME LIKE "mymap(%).a"
```

```
NAME="fooName=MyMBean" ATTRNAME MATCHES "mymap\(((.*?)\)).a"
```

Using Wildcards in Watch Rule Instance Names

Within Harvester watch rules, you can use the `*` wildcard to specify portions of an `ObjectName`, giving you the ability to watch for multiple instances of multiple types.

For example, to specify the `OpenSocketsCurrentCount` attribute for all instances of the `ServerRuntimeMBean` that begin with the name `managed`, use the following syntax:

```
`${com.bea:*Name=managed*Type=ServerRuntime*//OpenSocketCurrentCount}
```

Alternatively, you can use JMX `ObjectName` query patterns, as shown here:

```
`${mydomain:Key1=MyMBean,*//simpleAttribute}
```

Note: The `ObjectName` query pattern syntax supported by the Harvester will be whatever is supported by the underlying JMX implementation. The above example demonstrates syntax supported by JDK 5 and later. Refer to the JavaDoc for `javax.management.ObjectName` for the specific JDK version being used to run the server for the full syntax that is supported.

Specifying Complex Attributes in Harvester Watch Rules

You can specify complex attributes (a collection, an array type or an `Object` with nested intrinsic attribute types) within Harvester watch rule expressions. There are several ways to do this.

The following example shows a drill-down into a nested attribute in a complex type, which is then checked to see if it is greater than 0:

```
`${somedomain:name=MyMbean//complexAttribute.nestedAttribute} > 0
```

You can also use wildcards to specify multiple `Map` keys. The following wildcards are available for specifying complex attributes:

- You can use `*` to specify all key values for `Map` attributes.
- You can use `%` to replace parts of a `Map` key string and identify a group of keys that match a particular pattern.

In addition, you can use a comma-separated list to specify a discrete set of key values.

In this example:

```
#{[com.bea.foo.BarClass]//aList[*].(some%partialKey%).(aValue,bValue)} > 0
```

the rule would examine all elements of the `aList` attribute on all instances of the `com.bea.foo.BarClass`, drilling down into a nested map for all keys starting with the text `some` and containing the text `partialKey` afterwards. The returned values are assumed to be `Map` instances, from which values for the keys `aValue` and `bValue` will be compared to see if they are greater than 0.

When using the `MethodInvocationStatistics` attribute on the `WLDFInstrumentationRuntime` type, the system needs to determine the type from the variable. If the system can't determine the type when validating the attribute expression, the expression won't work. For example, the expression:

```
#{ com.bea:Name=myScope, * //MethodInvocationStatistics(...).( ...)
```

will not work. You must explicitly declare the type in this situation, as shown in this code example, which drills down into the nested map structure:

```
$(com.bea:Name=hello,Type=WLDFInstrumentationRuntime,*//MethodInvocationStatistics(*)[*](*)(count)) >= 1
```

WebLogic Scripting Tool Examples

The following examples use WLST and JMX to interact with WLDF components:

- “[Example: Dynamically Creating DyeInjection Monitors](#)” on page D-1
- “[Example: Configuring a Watch and a JMX Notification](#)” on page D-5
- “[Example: Writing a JMXWatchNotificationListener Class](#)” on page D-8
- “[Example: Registering MBeans and Attributes For Harvesting](#)” on page D-12

For information on running WebLogic Scripting Tool (`weblogic.WLST`) scripts, see “[Running WLST from Ant](#)” in *Using the WebLogic Scripting Tool*. For information on developing JMX applications, see *Developing Manageable Applications with JMX*.

Example: Dynamically Creating DyeInjection Monitors

This demonstration script (see [Listing D-1](#)) shows how to use the `weblogic.WLST` tool to create a `DyeInjection` monitor dynamically. This script:

- Connects to a server (boots the server first if necessary).
- Looks up or creates a WLDF System Resource.
- Creates the `DyeInjection` monitor.
- Sets the dye criteria.
- Enables the monitor.

- Saves and activates the configuration.
- Enables the Diagnostic Context feature via the `ServerDiagnosticConfigMBean`.

The demonstration script in [Listing D-1](#) only configures the dye monitor, which injects dye values into the diagnostic context. To trigger events, you must implement downstream diagnostic monitors that use dye filtering to trigger on the specified dye criteria. An example downstream monitor artifact is shown in [Listing D-2](#). This must be placed in a file named `weblogic-diagnostics.xml` and placed into the `META-INF` directory of a application archive. It is also possible to create a monitor using a JSR-88 deployment plan. For more information on deploying applications, see [Deploying Applications to WebLogic Server](#).

Listing D-1 Example: Using WLST to Dynamically Create DyeInjection Monitors (demoDyeMonitorCreate.py)

```
# Script name: demoDyeMonitorCreate.py

#####
# Demo script showing how to create a DyeInjectionMonitor dynamically
# via WLST. This script will:
# - Connect to a server, booting it first if necessary
# - Look up or create a WLDF System Resource
# - Create the DyeInjection Monitor (DIM)
# - Set the dye criteria
# - Enable the monitor
# - Save and activate
# - Enable the Diagnostic Context functionality via the
#   ServerDiagnosticConfig MBean

# Note: This will only configure the dye monitor, which will inject dye
# values into the Diagnostic Context. To trigger events requires the
# existence of "downstream" monitors set to trigger on the specified
# dye criteria.
#####
myDomainDirectory="domain"
url="t3://localhost:7001"
user="weblogic"
password="weblogic"
myServerName="myserver"
myDomain="mydomain"
```

```

props="weblogic.GenerateDefaultConfig=true,weblogic.RootDirectory="\
      +myDomainDirectory
try:
    connect(user,password,url)
except:
    startServer(adminServerName=myServerName, domainName=myDomain,
                username=user,password=password,systemProperties=props,
                domainDir=myDomainDirectory,block="true")
    connect(user,password,url)

# Start an edit session
edit()
startEdit()
cd ("/")

# Look up or create the WLDF System resource.
wldfResourceName = "mywldf"
myWldfVar = cmo.lookupSystemResource(wldfResourceName)
if myWldfVar==None:
    print "Unable to find named resource,\
          creating WLDF System Resource: " + wldfResourceName
    myWldfVar=cmo.createWLDFSystemResource(wldfResourceName)

# Target the System Resource to the demo server.
wldfServer=cmo.lookupServer(serverName)
myWldfVar.addTarget(wldfServer)

# create and set properties of the DyeInjection Monitor (DIM).
mywldfResource=myWldfVar.getWLDFResource()
mywldfInst=mywldfResource.getInstrumentation()
mywldfInst.setEnabled(1)
monitor=mywldfInst.createWLDFInstrumentationMonitor("DyeInjection")
monitor.setEnabled(1)

# Need to include newlines when setting properties
# on the DyeInjection monitor.
monitor.setProperties("\nUSER1=larry@celtics.com\
                    \nUSER2=brady@patriots.com\n")
monitor.setDyeFilteringEnabled(1)

```

```
# Enable the diagnostic context functionality via the
# ServerDiagnosticConfig.
cd("/Servers/"+serverName+"/ServerDiagnosticConfig/"+serverName)
cmo.setDiagnosticContextEnabled(1)

# save and disconnect
save()
activate()
disconnect()
exit()
```

Listing D-2 Example: Downstream Monitor Artifact

```
<?xml version="1.0" encoding="UTF-8"?>
<wldf-resource xmlns="http://www.bea.com/ns/weblogic/weblogic-diagnostics"
xmlns:xsi="http://www.w3.org/2001/XMLSchema-instance">
  <instrumentation>
    <enabled>true</enabled>
    <!-- Servlet Session Monitors -->
    <wldf-instrumentation-monitor>
      <name>Servlet_Before_Session</name>
      <enabled>true</enabled>
      <dye-mask>USER1</dye-mask>
      <dye-filtering-enabled>true</dye-filtering-enabled>
      <action>TraceAction</action>
      <action>StackDumpAction</action>
      <action>DisplayArgumentsAction</action>
      <action>ThreadDumpAction</action>
    </wldf-instrumentation-monitor>
    <wldf-instrumentation-monitor>
      <name>Servlet_After_Session</name>
      <enabled>true</enabled>
      <dye-mask>USER2</dye-mask>
      <dye-filtering-enabled>true</dye-filtering-enabled>
      <action>TraceAction</action>
      <action>StackDumpAction</action>
    </wldf-instrumentation-monitor>
  </instrumentation>
</wldf-resource>
```

```

        <action>DisplayArgumentsAction</action>
        <action>ThreadDumpAction</action>
    </wldf-instrumentation-monitor>
</instrumentation>
</wldf-resource>

```

Example: Configuring a Watch and a JMX Notification

This demonstration script (see [Listing D-3](#)) shows how to use the `weblogic.WLST` tool to configure a watch and a JMX notification using the WLDF Watch and Notification component. This script:

- Connects to a server and boots the server first if necessary.
- Looks up/creates a WLDF system resource.
- Creates a watch and watch rule on the `ServerRuntimeMBean` for the `OpenSocketsCurrentCount` attribute.
- Configures the watch to use a `JMXNotification` medium.

This script can be used in conjunction with the following files and scripts:

- The `JMXWatchNotificationListener.java` class (see [“Example: Writing a JMXWatchNotificationListener Class”](#) on page D-8).
- The `demoHarvester.py` script, which registers the `OpenSocketsCurrentCount` attribute with the harvester for collection (see [“Example: Registering MBeans and Attributes For Harvesting”](#) on page D-12).

To see these files work together, perform the following steps:

1. To run the watch configuration script (`demoWatch.py`), type:

```
java weblogic.WLST demoWatch.py
```
2. To compile the `JMXWatchNotificationListener.java` source, type:

```
javac JMXWatchNotificationListener.java
```
3. To run the `JMXWatchNotificationListener.class` file, type:

```
java JMXWatchNotificationListener
```

Note: Be sure the current directory is in your class path, so it will find the class file you just created.

4. To run the `demoHarvester.py` script, type:

```
java weblogic.WLST demoHarvester.py
```

When the `demoHarvester.py` script runs, it triggers the `JMXNotification` for the watch configured in step 1.

Listing D-3 Example: Watch and JMXNotification (demoWatch.py)

```
# Script name: demoWatch.py
#####
# Demo script showing how to configure a Watch and a JMXNotification
# using the WLDF Watches and Notification framework.
# The script will:
# - Connect to a server, booting it first if necessary
# - Look up or create a WLDF System Resource
# - Create a watch and watch rule on the ServerRuntimeMBean for the
#   "OpenSocketsCurrentCount" attribute
# - Configure the watch to use a JMXNotification medium
#
# This script can be used in conjunction with
# - the JMXWatchNotificationListener.java class
# - the demoHarvester.py script, which registers the
#   "OpenSocketsCurrentCount" attribute with the harvester for collection.
# To see these work together:
# 1. Run the watch configuration script
#     java weblogic.WLST demoWatch.py
# 2. Compile and run the JMXWatchNotificationListener.java source code
#     javac JMXWatchNotificationListener.java
#     java JMXWatchNotificationListener
# 3. Run the demoHarvester.py script
#     java weblogic.WLST demoHarvester.py
# When the demoHarvester.py script runs, it triggers the
# JMXNotification for the watch configured in step 1.
#####
myDomainDirectory="domain"
url="t3://localhost:7001"
user="weblogic"
```

Example: Configuring a Watch and a JMX Notification

```
myServerName="myserver"
myDomain="mydomain"
props="weblogic.GenerateDefaultConfig=true\
      weblogic.RootDirectory="+myDomainDirectory

try:
    connect(user,user,url)
except:
    startServer(adminServerName=myServerName, domainName=myDomain,
                username=user, password=user, systemProperties=props,
                domainDir=myDomainDirectory, block="true")
    connect(user,user,url)

edit()
startEdit()

# Look up or create the WLDF System resource
wldfResourceName = "mywldf"
myWldfVar = cmo.lookupSystemResource(wldfResourceName)
if myWldfVar==None:
    print "Unable to find named resource"
    print "creating WLDF System Resource: " + wldfResourceName
    myWldfVar=cmo.createWLDFSystemResource(wldfResourceName)

# Target the System Resource to the demo server
wldfServer=cmo.lookupServer(myServerName)
myWldfVar.addTarget(wldfServer)

cd("/WLDFSystemResources/mywldf/WLDFResource/mywldf/WatchNotification/mywldf")
watch=cmo.createWatch("mywatch")
watch.setEnabled(1)
jmxnot=cmo.createJMXNotification("myjmx")
watch.addNotification(jmxnot)

serverRuntime()
cd("/")
on=cmo.getObject().getCanonicalName()
watch.setRuleExpression("${"+on+"} > 1")
watch.getRuleExpression()
```

```
watch.setRuleExpression("${"+on+"//OpenSocketsCurrentCount} > 1")
watch.setAlarmResetPeriod(10000)

edit()
save()
activate()
disconnect()
exit()
```

Example: Writing a JMXWatchNotificationListener Class

[Listing D-4](#) shows how to write a `JMXWatchNotificationListener`.

Listing D-4 Example: JMXWatchNotificationListener Class (JMXWatchNotificationListener.java)

```
import javax.management.*;
import weblogic.diagnostics.watch.*;
import weblogic.diagnostics.watch.JMXWatchNotification;
import javax.management.Notification;
import javax.management.remote.JMXServiceURL;
import javax.management.remote.JMXConnectorFactory;
import javax.management.remote.JMXConnector;
import javax.naming.Context;
import java.util.Hashtable;
import weblogic.management.mbeanservers.runtime.RuntimeServiceMBean;

public class JMXWatchNotificationListener implements NotificationListener,
Runnable {

    private MBeanServerConnection rmbs = null;
    private String notifName = "myjmx";
    private int notifCount = 0;
    private String serverName = "myserver";

    public JMXWatchNotificationListener(String serverName) {
    }
}
```

Example: Writing a JMXWatchNotificationListener Class

```
public void register() throws Exception {
    rmbs = getRuntimeMBeanServerConnection();
    addNotificationHandler();
}

public void handleNotification(Notification notif, Object handback) {
    synchronized (this) {
        try {
            if (notif instanceof JMXWatchNotification) {
                WatchNotification wNotif =
                    ((JMXWatchNotification)notif).getExtendedInfo();
                notifCount++;

                System.out.println("=====");
                System.out.println("Notification name:      " +
                    notifName + " called. Count= " + notifCount + ".");
                System.out.println("Watch severity:          " +
                    wNotif.getWatchSeverityLevel());
                System.out.println("Watch time:              " +
                    wNotif.getWatchTime());
                System.out.println("Watch ServerName:       " +
                    wNotif.getWatchServerName());
                System.out.println("Watch RuleType:         " +
                    wNotif.getWatchRuleType());
                System.out.println("Watch Rule:             " +
                    wNotif.getWatchRule());
                System.out.println("Watch Name:             " +
                    wNotif.getWatchName());
                System.out.println("Watch DomainName:      " +
                    wNotif.getWatchDomainName());
                System.out.println("Watch AlarmType:        " +
                    wNotif.getWatchAlarmType());
                System.out.println("Watch AlarmResetPeriod: " +
                    wNotif.getWatchAlarmResetPeriod());
                System.out.println("=====");
            }
        } catch (Throwable x) {
            System.out.println("Exception occurred processing JMX watch
                notification: " + notifName + "\n" + x);
        }
    }
}
```

WebLogic Scripting Tool Examples

```
        x.printStackTrace();
    }
}
}

private void addNotificationHandler() throws Exception {
    /*
    * The JMX Watch notification listener registers with a Runtime MBean
    * that matches the name of the corresponding watch bean.
    * Each watch has its own Runtime MBean instance.
    */

    ObjectName oname =
        new ObjectName(
            "com.bea:ServerRuntime=" + serverName + ",Name=" +
            JMXWatchNotification.GLOBAL_JMX_NOTIFICATION_PRODUCER_NAME +
            ",Type=WLDFFWatchJMXNotificationRuntime," +
            "WLDFFWatchNotificationRuntime=WatchNotification," +
            "WLDFFRuntime=WLDFFRuntime"
        );

    System.out.println("Adding notification handler for: " +
        oname.getCanonicalName());
    rmbs.addNotificationListener(oname, this, null, null);
}

private void removeNotificationHandler(String name,
    NotificationListener list) throws Exception {
    ObjectName oname =
        new ObjectName(
            "com.bea:ServerRuntime=" + serverName + ",Name=" +
            JMXWatchNotification.GLOBAL_JMX_NOTIFICATION_PRODUCER_NAME +
            ",Type=WLDFFWatchJMXNotificationRuntime," +
            "WLDFFWatchNotificationRuntime=WatchNotification," +
            "WLDFFRuntime=WLDFFRuntime"
        );

    System.out.println("Removing notification handler for: " +
        oname.getCanonicalName());
    rmbs.removeNotificationListener(oname, list);
}
```

```

public void run() {
    try {
        System.out.println("VM shutdown, unregistering notification
            listener");
        removeNotificationHandler(notifName, this);
    } catch (Throwable t) {
        System.out.println("Caught exception in shutdown hook");
        t.printStackTrace();
    }
}

private String user = "weblogic";
private String password = "weblogic";

public MBeanServerConnection getRuntimeMBeanServerConnection()
    throws Exception {
    String JNDI = "/jndi/";

    JMXServiceURL serviceURL;
    serviceURL =
        new JMXServiceURL("t3", "localhost", 7001,
            JNDI + RuntimeServiceMBean.MBEANSERVER_JNDI_NAME);

    System.out.println("URL=" + serviceURL);

    Hashtable h = new Hashtable();
    h.put(Context.SECURITY_PRINCIPAL, user);
    h.put(Context.SECURITY_CREDENTIALS, password);
    h.put(JMXConnectorFactory.PROTOCOL_PROVIDER_PACKAGES,
        "weblogic.management.remote");
    JMXConnector connector = JMXConnectorFactory.connect(serviceURL, h);
    return connector.getMBeanServerConnection();
}

public static void main(String[] args) {
    try {
        String serverName = "myserver";
        if (args.length > 0)
            serverName = args[0];
        JMXWatchNotificationListener listener =
            new JMXWatchNotificationListener(serverName);
    }
}

```

```
System.out.println("Adding shutdown hook");
Runtime.getRuntime().addShutdownHook(new Thread(listener));
listener.register();
// Sleep waiting for notifications
Thread.sleep(Long.MAX_VALUE);
} catch (Throwable e) {
    e.printStackTrace();
} // end of try-catch
} // end of main()
}
```

Example: Registering MBeans and Attributes For Harvesting

This demonstration script shows how to use the `weblogic.WLST` tool to register MBeans and attributes for collection by the WLDF Harvester. This script:

- Connects to a server and boots the server first if necessary.
- Looks up or creates a WLDF system resource.
- Sets the sampling frequency.
- Adds a type for collection.
- Adds an attribute of a specific instance for collection.
- Saves and activates the configuration.
- Displays a few cycles of the harvested data.

Listing D-5 Example: MBean Registration and Data Collection (`demoHarvester.py`)

```
# Script name: demoHarvester.py
#####
# Demo script showing how register MBeans and attributes for collection
# by the WLDF Harvester Service. This script will:
# - Connect to a server, booting it first if necessary
```

Example: Registering MBeans and Attributes For Harvesting

```
# - Look up or create a WLDf System Resource
# - Set the sampling frequency
# - Add a type for collection
# - Add an attribute of a specific instance for collection
# - Save and activate
#####
from java.util import Date
from java.text import SimpleDateFormat
from java.lang import Long
import jarray

#####
# Helper functions for adding types/attributes to the harvester
# configuration
#####
def findHarvestedType(harvester, typeName):
    htypes=harvester.getHarvestedTypes()
    for ht in (htypes):
        if ht.getName() == typeName:
            return ht
    return None

def addType(harvester, mbeanInstance):
    typeName = "weblogic.management.runtime."\
        + mbeanInstance.getType() + "MBean"
    ht=findHarvestedType(harvester, typeName)
    if ht == None:
        print "Adding " + typeName + " to harvestables collection for "\
            + harvester.getName()
        ht=harvester.createHarvestedType(typeName)
    return ht;

def addAttributeToHarvestedType(harvestedType, targetAttribute):
    currentAttributes = PyList()
    currentAttributes.extend(harvestedType.getHarvestedAttributes());
    print "Current attributes: " + str(currentAttributes)
    try:
        currentAttributes.index(targetAttribute)
        print "Attribute is already in set"
    return
```

```
except ValueError:
    print targetAttribute + " not in list, adding"
    currentAttributes.append(targetAttribute)
    newSet = jarray.array(currentAttributes, java.lang.String)
    print "New attributes for type "\
          + harvestedType.getName() + ": " + str(newSet)
    harvestedType.setHarvestedAttributes(newSet)
    return

def addTypeForInstance(harvester, mbeanInstance):
    typeName = "weblogic.management.runtime."\
              + mbeanInstance.getType() + "MBean"
    return addTypeByName(harvester, typeName, 1)

def addInstanceToHarvestedType(harvester, mbeanInstance):
    harvestedType = addTypeForInstance(harvester, mbeanInstance)
    currentInstances = PyList()
    currentInstances.extend(harvestedType.getHarvestedAttributes());
    on = mbeanInstance.getObjectName().getCanonicalName()
    print "Adding " + str(on) + " to set of harvested instances for type "\
          + harvestedType.getName()
    print "Current instances : " + str(currentInstances)
    for inst in currentInstances:
        if inst == on:
            print "Found " + on + " in existing set"
            return harvestedType
    # only get here if the target attribute is not in the set
    currentInstances.append(on)
    # convert the new list back to a Java String array
    newSet = jarray.array(currentInstances, java.lang.String)
    print "New instance set for type " + harvestedType.getName()\
          + ": " + str(newSet)
    harvestedType.setHarvestedInstances(newSet)
    return harvestedType

def addTypeByName(harvester, _typeName, knownType=0):
    ht=findHarvestedType(harvester, _typeName)
    if ht == None:
        print "Adding " + _typeName + " to harvestables collection for "\
              + harvester.getName()
```

Example: Registering MBeans and Attributes For Harvesting

```
    ht=harvester.createHarvestedType(_typeName)
    if knownType == 1:
        print "Setting known type attribute to true for " + _typeName
        ht.setKnownType(knownType)
    return ht;

def addAttributeForInstance(harvester, mbeanInstance, attributeName):
    typeName = mbeanInstance.getType() + "MBean"
    ht = addInstanceToHarvestedType(harvester, mbeanInstance)
    return addAttributeToHarvestedType(ht,attributeName)

#####
# Display the currently registered types for the specified harvester
#####
def displayHarvestedTypes(harvester):
    harvestedTypes = harvester.getHarvestedTypes()
    print ""
    print "Harvested types:"
    print ""
    for ht in (harvestedTypes):
        print "Type: " + ht.getName()
        attributes = ht.getHarvestedAttributes()
        if attributes != None:
            print "  Attributes: " + str(attributes)
        instances = ht.getHarvestedInstances()
        print "  Instances: " + str(instances)
        print ""
    return

#####
# Main script flow -- create a WLDF System resource and add harvestables
#####
myDomainDirectory="domain"
url="t3://localhost:7001"
user="weblogic"
myServerName="myserver"
myDomain="mydomain"
props="weblogic.GenerateDefaultConfig=true,weblogic.RootDirectory="\
    +myDomainDirectory
try:
```

WebLogic Scripting Tool Examples

```
connect(user,user,url)
except:
    startServer(adminServerName=myServerName,domainName=myDomain,
        username=user,password=user,systemProperties=props,
        domainDir=myDomainDirectory,block="true")
    connect(user,user,url)

# start an edit session
edit()
startEdit()
cd("/")

# Look up or create the WLDF System resource
wldfResourceName = "mywldf"
systemResource = cmo.lookupSystemResource(wldfResourceName)
if systemResource==None:
    print "Unable to find named resource,\
        creating WLDF System Resource: " + wldfResourceName
    systemResource=cmo.createWLDFSystemResource(wldfResourceName)

# Obtain the harvester bean instance for configuration
print "Getting WLDF Resource Bean from " + str(wldfResourceName)
wldfResource = systemResource.getWLDFResource()
print "Getting Harvester Configuration Bean from " + wldfResourceName
harvester = wldfResource.getHarvester()
print "Harvester: " + harvester.getName()

# Target the WLDF System Resource to the demo server
wldfServer=cmo.lookupServer(myServerName)
systemResource.addTarget(wldfServer)

# The harvester Jython wrapper maintains refs to
# the SystemResource objects
harvester.setSamplePeriod(5000)
harvester.setEnabled(1)

# add an instance-based RT MBean attribute for collection
serverRuntime()
cd("/")
addAttributeForInstance(harvester, cmo, "OpenSocketsCurrentCount")
```

Example: Registering MBeans and Attributes For Harvesting

```
# have to return to the edit tree to activate
edit()

# add a RT MBean type, all instances and attributes,
# with KnownType = "true"
addTypeByName(harvester,
              "weblogic.management.runtime.WLDFInstrumentationRuntimeMBean", 1)
addTypeByName(harvester,
              "weblogic.management.runtime.WLDFWatchNotificationRuntimeMBean", 1)
addTypeByName(harvester,
              "weblogic.management.runtime.WLDFHarvesterRuntimeMBean", 1)

try:
    save()
    activate(block="true")
except:
    print "Error while trying to save and/or activate."
    dumpStack()

# display the data
displayHarvestedTypes(harvester)

disconnect()
exit()
```

WebLogic Scripting Tool Examples

Terminology

Key terms that you will encounter throughout the diagnostic and monitoring documentation include the following:

artifact

Any resulting physical entity, or data, generated and persisted to disk by the WebLogic Diagnostic Framework that can be used later for diagnostic analysis. For example, the diagnostic image file that is created when the server fails is an artifact. The diagnostic image artifact is provided to support personnel for analysis to determine why the server failed. The WebLogic Diagnostic Framework produces a number of different artifacts.

context creation

If diagnostic monitoring is enabled, a diagnostic context is created, initialized, and populated by WebLogic Server when a request enters the system. Upon request entry, WebLogic Server determines whether a diagnostic context is included in the request. If so, the request is propagated with the provided context. If not, WebLogic Server creates a new context with a specific name (`weblogic.management.DiagnosticContext`). The contextual data for the diagnostic context is stored in the diagnostic context payload. Thus, within the scope of a request execution, existence of the diagnostic context is guaranteed.

context payload

The actual contextual data for the diagnostic context is stored in the Context Payload. See also [context creation](#), [diagnostic context](#), [request dyeing](#).

data stores

Data stores are a collection of data, or records, represented in a tabular format. Each record in the table represents a datum. Columns in the table describe various characteristics of

the datum. Different data stores may have different columns; however, most data stores have some shared columns, such as the time when the data item was collected. In WebLogic Server, information captured by WebLogic Diagnostic Framework is segregated into logical data stores, separated by the types of diagnostic data. For example, Server logs, HTTP logs, and harvested metrics are captured in separate data stores.

diagnostic action

Business logic or diagnostic code that is executed when a joinpoint defined by a pointcut is reached. Diagnostic actions, which are associated with specific pointcuts, specify the code to execute at a joinpoint. Put another way, a pointcut declares the location and a diagnostic action declares what is to be done at the locations identified by the pointcut. Diagnostic actions provide visibility into a running server and applications. Diagnostic actions specify the diagnostic activity that is to take place at locations, or pointcuts, defined by the monitor in which it is implemented. Without a defined action, a diagnostic monitor is useless.

Depending on the functionality of a diagnostic action, it may need a certain environment to do its job. Such an environment must be provided by the monitor to which the diagnostic action is attached; therefore, diagnostic actions can be used only with compatible monitors. Hence, diagnostic actions are classified by type so that their compatibility with monitors can be determined.

To facilitate the implementation of useful diagnostic monitors, a library of suitable diagnostic actions is provided with the WebLogic Server product.

diagnostic context

The WebLogic Diagnostic Framework adds contextual information to all requests when they enter the system. You can use this contextual information, referred to as the diagnostic context, to reconstruct transactional events, as well correlate events based on the timing of the occurrence or logical relationships. Using diagnostic context you can reconstruct or piece together a thread of execution from request to response.

Various diagnostic components, for example, the logging services and diagnostic monitors, use the diagnostic context to tag generated data events. Using the tags, the diagnostic data can be collated, filtered and correlated by the WebLogic Diagnostic Framework and third-party tools.

The diagnostic context also makes it possible to generate diagnostic information only when contextual information in the diagnostic context satisfies certain criteria. This capability enables you to keep the volume of generated information to manageable levels and keep the overhead of generating such information relatively low. See also [context creation](#), [context payload](#), [request dyeing](#).

diagnostic image

An artifact containing key state from an instance of a server that is meant to serve as a server-level state dump for the purposes of diagnosing significant failures. This artifact can be used to diagnose and analyze problems even after the server has cycled.

diagnostic module

A diagnostic module is the definition the configuration settings that are to applied to the WebLogic Diagnostic Framework. The configuration settings determine what data is to be collected and processed, how the data is to be analyzed and archived, what notifications and alarms are to be fired, and the operating parameters of the Diagnostic Image Capture component. Once a diagnostic module has been defined, or configured, it can be distributed to a running server where the data is collected.

diagnostic monitor

A diagnostic monitor is a unit of diagnostic code that defines 1) the locations in a program where the diagnostic code will be added and 2) the diagnostic actions that will be executed at those locations.

WebLogic Server provides a library of useful diagnostic monitors. Users can integrate these monitors into server and application classes. Once integrated, the monitors take effect at server startup for server classes and application deployment and redeployment for application classes.

diagnostic notification

The action that occurs as a result of the successful evaluation of a watch rule. The WebLogic Diagnostic Framework supports these types of diagnostic notifications: Java Management Extensions (JMX), Java Message Service (JMS), Simple Mail Transfer Protocol (SMTP), Simple Network Management Protocol (SNMP), and WLDF Image Capture. See also [diagnostic image](#).

dye filtering

The process of looking at the dye mask and making the decision as to whether or not a diagnostic monitor should execute an action so as to generate a data event. Dye filtering is dependent upon dye masks. You must define dye masks in order for dye filtering to take place. See also [dye mask](#), [request dyeing](#).

dye mask

The entity that contains a predefined set of conditions that are used by dye filtering in diagnostic monitors to determine whether or not a data event should be generated. See also [dye filtering](#), [request dyeing](#).

harvestable entities

A harvestable entity is any entity that is available for data consumption via the Harvester. Once an entity is identified as a harvestable resource, the Harvester can engage the entity in the data collection process.

Harvestable entities provide access to the following information: harvestable attributes, values of harvestable attributes, meta-data for harvestable attributes, and the name of the harvestable entity. See also [harvestable data](#), [harvested data](#), [Harvester's configuration data set](#), [MBean type discovery](#).

harvestable data

Harvestable data (types, instances, attributes) is the set of data that potentially could be harvested when and if a harvestable entity is configured for harvesting. Therefore, the set of harvestable data exists independent of what data is configured for harvesting and of what data samples are taken.

The `WLDFHarvesterRuntimeMBean` provides the set of harvestable data for users. For a description of the information about harvestable data provided by this MBean, see the description of the `weblogic.management.runtime.WLDFHarvesterRuntimeMBean` in the *WebLogic Server MBean Reference*.

The WebLogic Diagnostic Framework only makes Runtime MBeans available as harvestable. In order for an MBean to be harvestable, it must be registered in the local WebLogic Server runtime MBean server. See also [harvestable entities](#), [harvested data](#), [Harvester's configuration data set](#), [MBean type discovery](#).

harvested data

A type, instance, or attribute is called harvested data if that data is currently being harvested. To meet these criteria the data must: 1) be configured to be harvested, 2) if applicable, it must have been discovered, and 3) it must not throw exceptions while being harvested.

See also [harvestable entities](#), [harvestable data](#), [Harvester's configuration data set](#), [MBean type discovery](#).

Harvester's configuration data set

The set of data to be harvested as defined by the Harvester's configuration. The configured data set can contain items that are not harvestable and items that are not currently being harvested.

See also [harvestable entities](#), [harvestable data](#), [harvested data](#), [Harvester's configuration data set](#).

joinpoint

A well defined point in the program flow where diagnostic code can be added. The Instrumentation component allows identification of such diagnostic joinpoints with an expression in a generic manner.

pointcut

A well defined set of joinpoints, typically identified by some generic expression. Pointcuts identify joinpoints, which are well-defined points in the flow of execution, such as a method call or method execution site. The Instrumentation component provides a mechanism to allow execution of specific diagnostic code at such pointcuts. The Instrumentation component adds such diagnostic code to the server and application code.

MBean (Managed Bean)

A Java object that provides a management interface for an underlying resource. An MBean is part of Java Management Extensions (JMX).

In the WebLogic Diagnostic Framework, MBean classes are used to configure the service and to monitor its runtime state. MBeans are registered with the MBean server that runs inside WebLogic Server. MBeans are implemented as standard MBeans which means that each class implements its own MBean interface.

MBean type discovery

For WebLogic Server entities, the set of harvestable types is known at system startup, but not the complete set of harvestable instances. For customer defined MBeans, however, the set of types can grow dynamically, as more MBeans appear at runtime. The process of detecting a new type based on the registration of a new MBean is called type discovery. MBean type discovery is only applicable to customer MBeans.

MBean type meta-data

The set of harvestable attributes for a type (and its instances) is defined by the meta-data for the type. Since the WebLogic Server model is MBeans, the meta-data is provided through `MBeanInfos`. Since WebLogic type information is always available, the set of harvestable attributes for WebLogic Server types (and existing and potential instances) is always available as well. However, for customer types, knowledge of the set of harvestable attributes is dependent on the existence of the type. And, the type does not exist until at least one instance is created. So the list of harvestable attributes on a user defined type is not known until at least one instance of the type is registered.

It is important to be aware of latencies in the availability of information for custom MBeans. Due to latencies, the Administration Console cannot provide complete lists of all harvestable data in its user selection lists for configuring the harvester. The set of harvestable data for WebLogic Server entities is always complete, but the set of harvestable data for customer entities (and even the set of entities itself) may not be complete.

meta-data

Meta-data is information that describes the information the WebLogic Diagnostic Framework collects. Because the service collects diagnostic information from different sources, the consumers of this information need to know what diagnostic information is

collected and available. To satisfy this need, the Data Accessor provides functionality to programmatically obtain this meta-data. The meta-data made available by means of the Data Accessor includes: 1) a list of supported data store types, for example, `SERVER_LOG`, `HTTP_LOG`, `HARVESTED_DATA`, 2) a list of available data stores, and 3) the layout of each data store, that is, information about columns in the data store.

metrics

Monitoring system operation and diagnosing problems depends on having data from running systems. Metrics are measurements of system performance. From these measurements, support personnel can determine whether the system is in good working order or a problem is developing.

In general, metrics are exposed to the WebLogic Diagnostic Framework as attributes on qualified MBeans. In WebLogic Server, metrics include performance measurements for the operating system, the virtual machine, the system runtime, and applications running on the server.

request dyeing

Requests can be dyed, or specially marked, to indicate that they are of special interest. For example, in a running system, it may be desirable to send a specially marked test request, which can be conditionally traced by the tracing monitors. This allows creation of highly focused diagnostic information without slowing down other requests.

Requests are typically marked when they enter the system by setting flags in the diagnostic context. The diagnostic context provides a number of flags, 64 in all, that can be independently set or reset.

See also [context creation](#), [context payload](#), [diagnostic context](#).

system image capture

Whenever a system fails, there is need to know its state when it failed. Therefore, a means of capturing system state upon failure is critical to failure diagnosis. A system image capture does just that. It creates, in essence, a diagnostic snapshot, or dump, from the system for the express purpose of diagnosing significant failures.

In WebLogic Server, you can configure the WebLogic Diagnostic Framework provides the First-Failure Notification feature to trigger system image captures automatically when the server experiences an abnormal shutdown. You can also implement watches to automatically trigger diagnostic image captures when significant failures occur and you can manually initiate diagnostic image captures on demand.

watch

A watch encapsulates all of the information for a watch rule. This includes the watch rule expression, the alarm settings for the watch, and the various notification handlers that will be fired once a watch rule expression evaluates to true.

weaving time

The time it takes to inspect server and application classes and insert the diagnostic byte code at well-defined locations, if necessary at class load time. The diagnostic byte code enables the WebLogic Diagnostic Framework to take diagnostic actions. Weaving time affects both the load time for server-level instrumented classes and application deployment time for application-level classes.

Terminology